

General Description

These N-Channel enhancement mode power field effect transistors are planar stripe, DMOS technology. This advanced technology has been especially tailored to minimize on-state resistance, provide superior switching performance, and withstand high energy pulse in the avalanche and commutation mode. These devices are well suited for high efficiency switch mode power supply

BVDSS	RDSON	ID
600V	0.47Ω	16A

Features

- 600V, 16A, $R_{DS(ON)} = 0.47\Omega @ V_{GS} = 10V$
- Improved dv/dt capability
- Fast switching
- 100% EAS Guaranteed
- Green Device Available

TO247 Pin Configuration

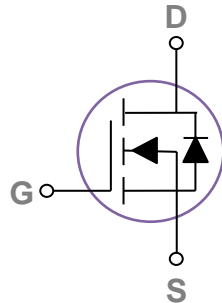
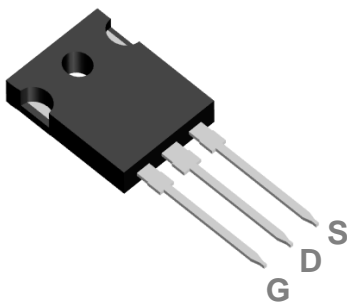

Applications

- High efficient switched mode power supplies
- TV Power
- Adapter/charger
- Server Power
- LED Lighting

Absolute Maximum Ratings $T_c=25^\circ\text{C}$ unless otherwise noted

Symbol	Parameter	Rating	Units
V_{DS}	Drain-Source Voltage	600	V
V_{GS}	Gate-Source Voltage	± 30	V
I_D	Drain Current – Continuous ($T_c=25^\circ\text{C}$)	16	A
	Drain Current – Continuous ($T_c=100^\circ\text{C}$)	10	A
I_{DM}	Drain Current – Pulsed ¹	64	A
EAS	Single Pulse Avalanche Energy ²	980	mJ
IAS	Single Pulse Avalanche Current ²	14	A
P_D	Power Dissipation ($T_c=25^\circ\text{C}$)	390	W
	Power Dissipation – Derate above 25°C	3.13	W/ $^\circ\text{C}$
T_{STG}	Storage Temperature Range	-55 to 150	$^\circ\text{C}$
T_J	Operating Junction Temperature Range	-55 to 150	$^\circ\text{C}$

Thermal Characteristics

Symbol	Parameter	Typ.	Max.	Unit
$R_{\theta JA}$	Thermal Resistance Junction to ambient	---	62	$^\circ\text{C}/\text{W}$
$R_{\theta JC}$	Thermal Resistance Junction to Case	---	0.36	$^\circ\text{C}/\text{W}$

Electrical Characteristics (T_J=25 °C, unless otherwise noted)
Off Characteristics

Symbol	Parameter	Conditions	Min.	Typ.	Max.	Unit
BV _{DSS}	Drain-Source Breakdown Voltage	V _{GS} =0V, I _D =250μA	600	---	---	V
I _{DSS}	Drain-Source Leakage Current	V _{DS} =600V, V _{GS} =0V, T _J =25°C	---	---	1	μA
		V _{DS} =480V, V _{GS} =0V, T _J =125°C	---	---	20	μA
I _{GSS}	Gate-Source Leakage Current	V _{GS} =±30V, V _{DS} =0V	---	---	±100	nA

On Characteristics

R _{DS(ON)}	Static Drain-Source On-Resistance	V _{GS} =10V, I _D =5A	---	0.39	0.47	Ω
V _{GS(th)}	Gate Threshold Voltage	V _{GS} =V _{DS} , I _D =250μA	2	3	4	V

Dynamic and switching Characteristics³

Q _g	Total Gate Charge	V _{DS} =300V, V _{GS} =10V, I _D =8A	---	51	80	nC
Q _{gs}	Gate-Source Charge		---	8.3	15	
Q _{gd}	Gate-Drain Charge		---	12.4	20	
T _{d(on)}	Turn-On Delay Time	V _{DD} =300V, V _{GS} =10V, R _G =6Ω I _D =8A	---	10	15	ns
T _r	Rise Time		---	15	25	
T _{d(off)}	Turn-Off Delay Time		---	20	30	
T _f	Fall Time		---	15	25	
C _{iss}	Input Capacitance	V _{DS} =300V, V _{GS} =0V, F=1MHz	---	2560	3800	pF
C _{oss}	Output Capacitance		---	59	90	
C _{rss}	Reverse Transfer Capacitance		---	7	11	
R _g	Gate resistance	V _{GS} =0V, V _{DS} =0V, F=1MHz	---	2.1	---	Ω

Drain-Source Diode Characteristics and Maximum Ratings

Symbol	Parameter	Conditions	Min.	Typ.	Max.	Unit
I _S	Continuous Source Current	V _G =V _D =0V, Force Current	---	---	16	A
I _{SM}	Pulsed Source Current		---	---	32	A
V _{SD}	Diode Forward Voltage	V _{GS} =0V, I _S =1A, T _J =25°C	---	---	1	V
t _{rr}	Reverse Recovery Time	V _R =400V, I _S =10A	---	380	---	ns
Q _{rr}	Reverse Recovery Charge	di/dt=100A/μs, T _J =25°C	---	4.8	---	μC

Note :

1. Repetitive Rating : Pulsed width limited by maximum junction temperature.
2. V_{DD}=50V, V_{GS}=10V, L=10mH, I_{AS}=14A., R_G=25Ω, Starting T_J=25°C.
3. Essentially independent of operating temperature.

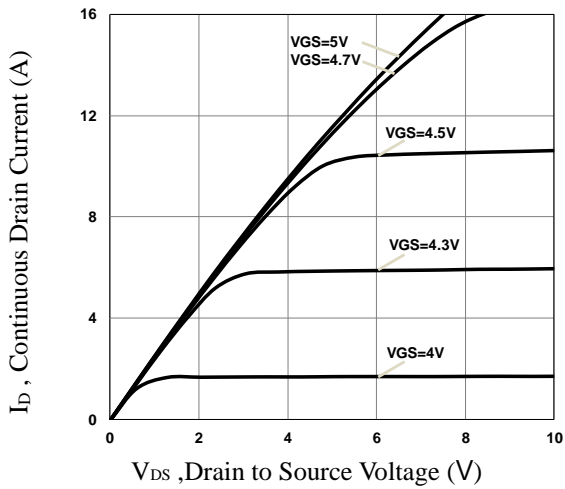

Fig.1 Typical Output Characteristics

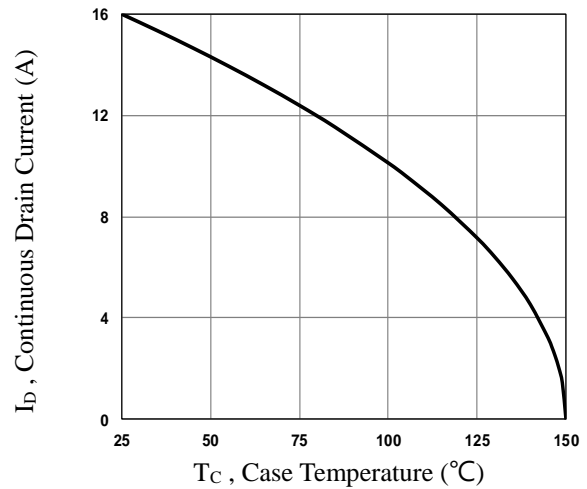

Fig.2 Continuous Drain Current vs. T_c

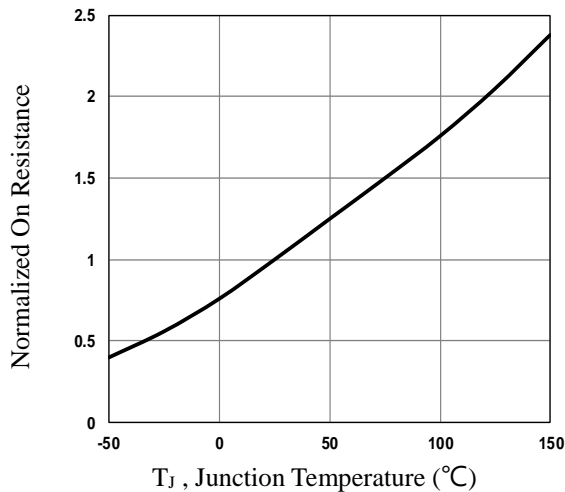

Fig.3 Normalized $R_{DS(on)}$ vs. T_j

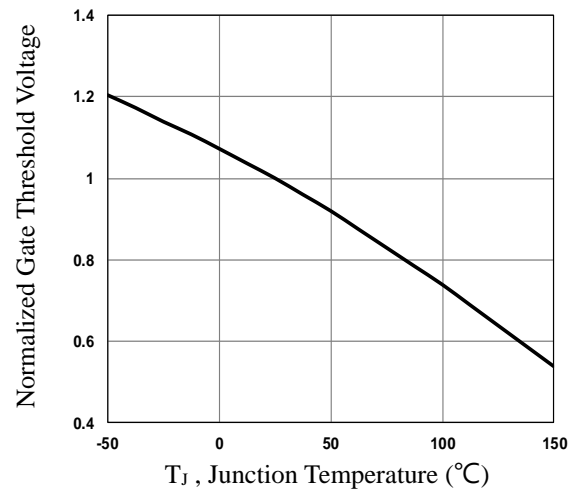

Fig.4 Normalized V_{th} vs. T_j

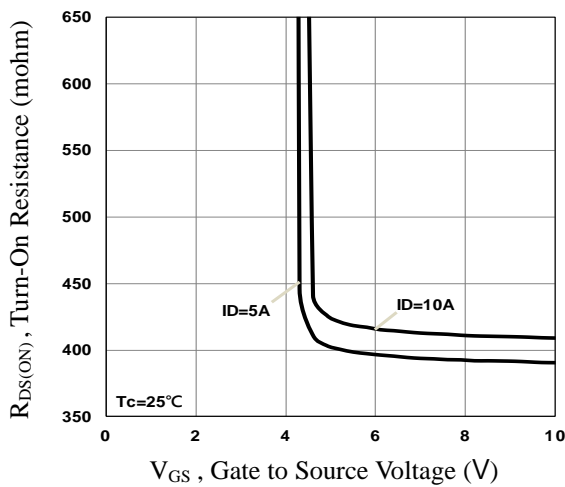

Fig.5 Turn-On Resistance vs. V_{GS}

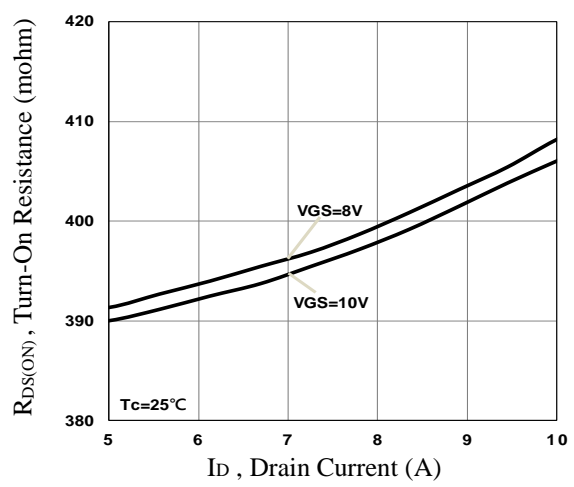

Fig.6 Turn-On Resistance vs. I_D

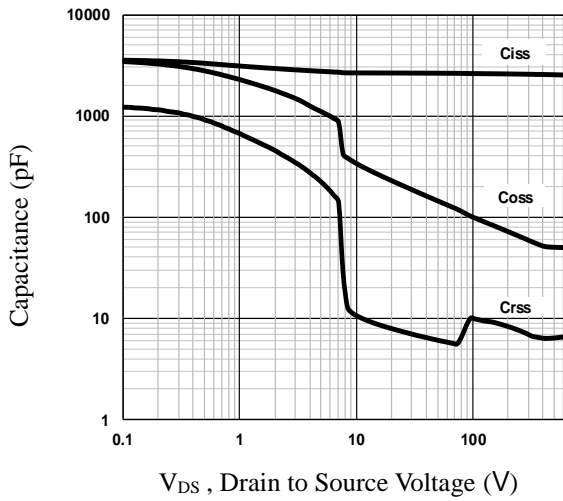

Fig.7 Capacitance Characteristics

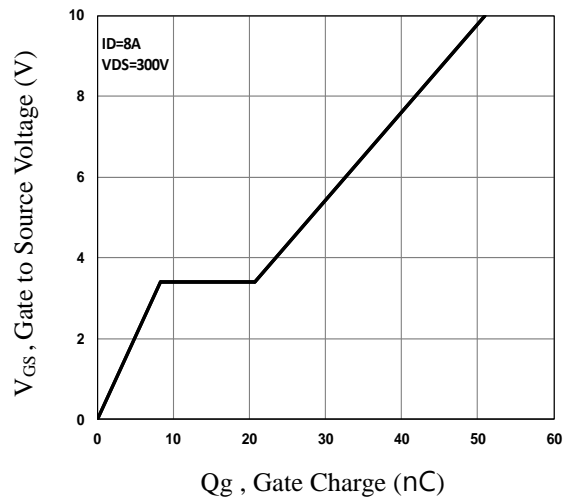

Fig.8 Gate Charge Characteristics

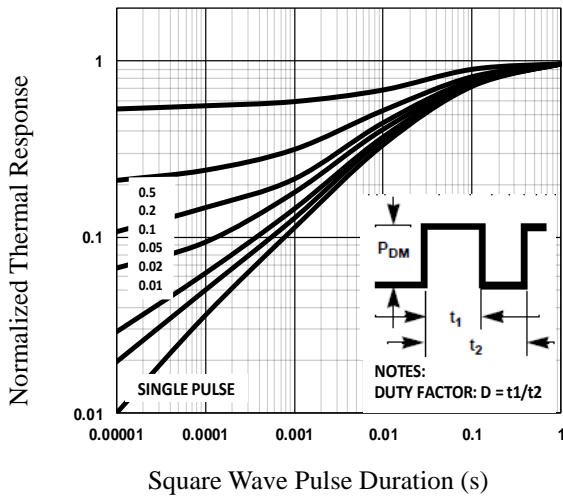

Fig.9 Normalized Transient Impedance

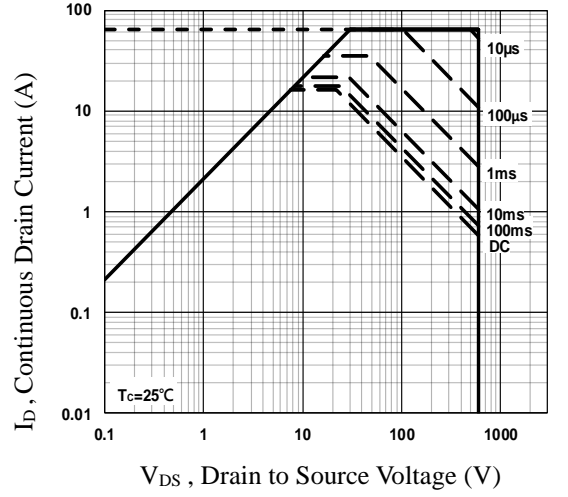

Fig.10 Maximum Safe Operation Area

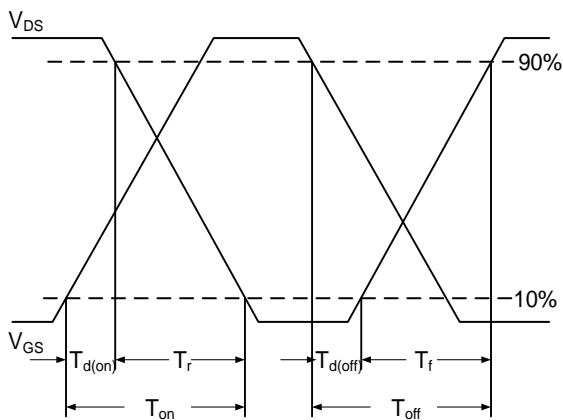

Fig.11 Switching Time Waveform

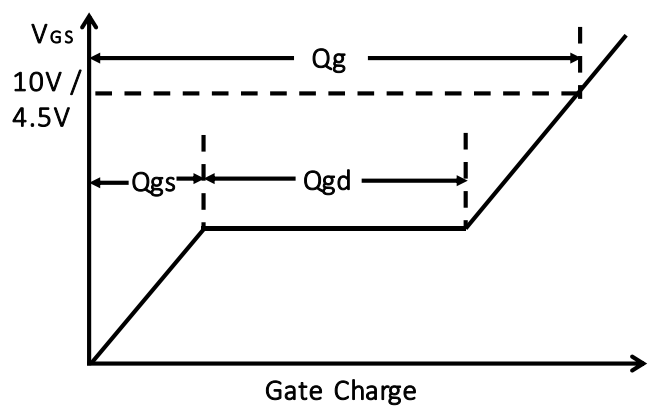
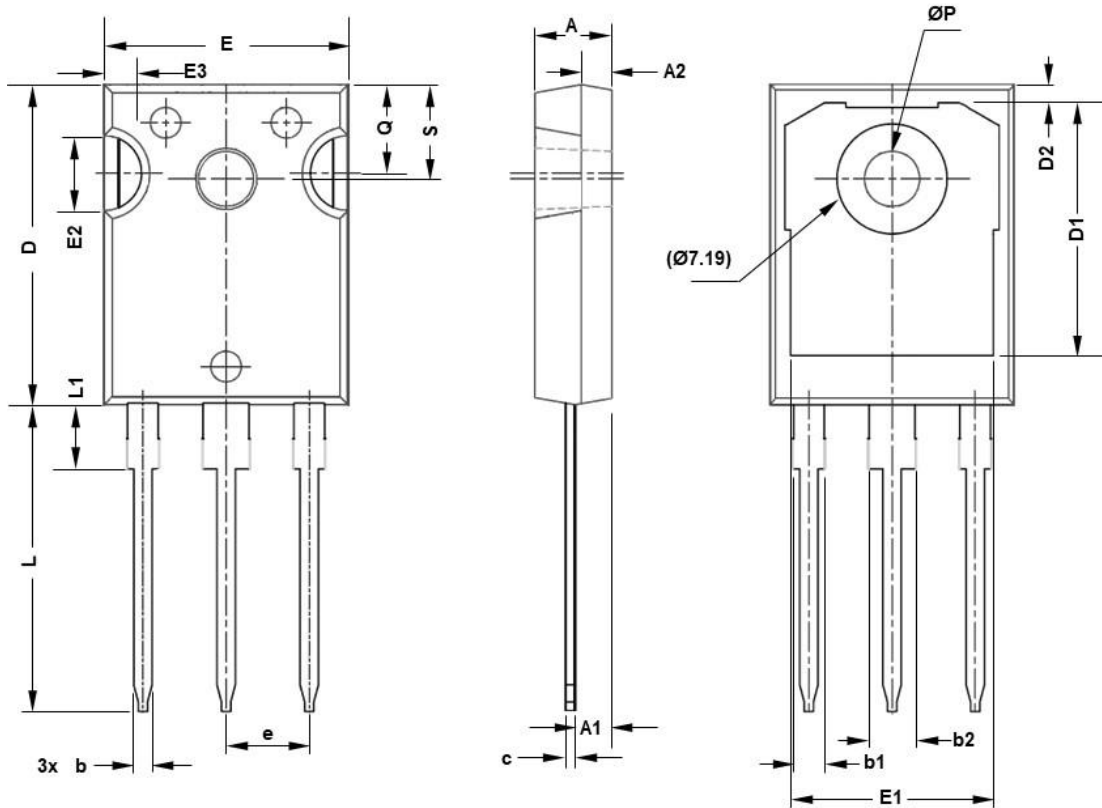

Fig.12 Gate Charge Waveform

TO247 PACKAGE INFORMATION

VERSION A



SYMBOL	mm		SYMBOL	mm	
	MIN	MAX		MIN	MAX
A	4.83	5.21	E2	4.32	5.49
A1	2.29	2.55	E3	2.15	2.80
A2	1.50	2.49	e	5.44BSC	
b	1.12	1.33	L	19.81	20.32
b1	1.91	2.39	L1	4.10	4.40
b2	2.87	3.22	ΦP	3.56	3.65
C	0.55	0.69	Q	5.39	6.20
D	20.80	21.10	S	6.04	6.30
D1	16.25	17.65			
D2	0.51	1.35			
E	15.75	16.13			
E1	13.46	14.16			

VERSION B

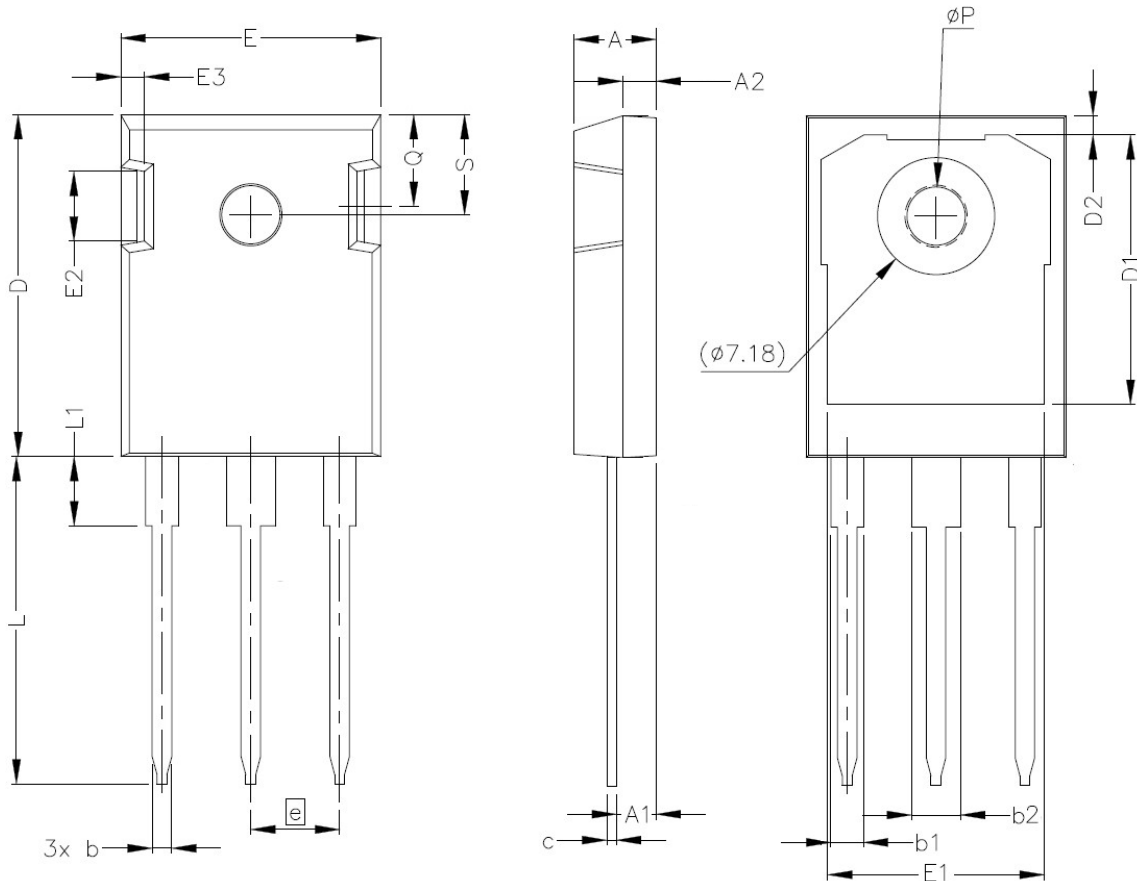

SYMBOL	mm		SYMBOL	mm	
	MIN	MAX		MIN	MAX
A	4.75	5.25	E2	3.70	5.30
A1	2.16	2.66	E3	1.00	2.75
A2	1.75	2.25	e	5.44BSC	
b	1.07	1.35	L	19.52	20.32
b1	1.90	2.41	L1	4.10	4.40
b2	2.87	3.38	ΦP	3.35	3.85
C	0.50	0.70	Q	5.40	6.20
D	20.60	21.40	S	6.15BSC	
D1	16.15	17.65			
D2	0.95	1.35			
E	15.50	16.10			
E1	12.40	13.60			