

## General Description

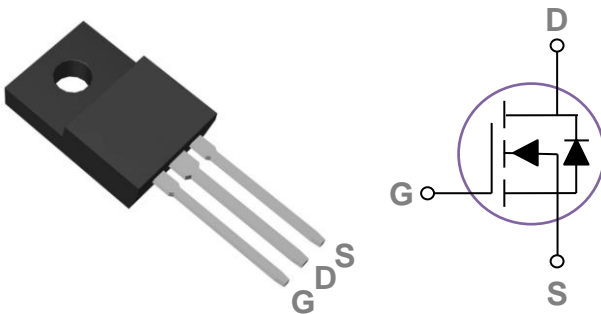
These N-Channel enhancement mode power field effect transistors are using trench DMOS technology. This advanced technology has been especially tailored to minimize on-state resistance, provide superior switching performance, and withstand high energy pulse in the avalanche and commutation mode. These devices are well suited for high efficiency fast switching applications.

BVDSS	RDSON	ID
200V	0.14Ω	18A

## Features

- 200V, 18A,  $R_{DS(ON)} = 0.14\Omega @ V_{GS} = 10V$
- Improved  $dv/dt$  capability
- Fast switching
- Green Device Available

## TO220F Pin Configuration



## Applications

- Networking
- Load Switch
- LED applications

## Absolute Maximum Ratings $T_c=25^\circ\text{C}$ unless otherwise noted

Symbol	Parameter	Rating	Units
$V_{DS}$	Drain-Source Voltage	200	V
$V_{GS}$	Gate-Source Voltage	$\pm 30$	V
$I_D$	Drain Current – Continuous ( $T_c=25^\circ\text{C}$ )	18	A
	Drain Current – Continuous ( $T_c=100^\circ\text{C}$ )	12	A
$I_{DM}$	Drain Current – Pulsed <sup>1</sup>	72	A
EAS	Single Pulse Avalanche Energy <sup>2</sup>	364	mJ
IAS	Single Pulse Avalanche Current <sup>2</sup>	27	A
$P_D$	Power Dissipation ( $T_c=25^\circ\text{C}$ )	60	W
	Power Dissipation – Derate above $25^\circ\text{C}$	0.48	W/ $^\circ\text{C}$
$T_{STG}$	Storage Temperature Range	-55 to 150	$^\circ\text{C}$
$T_J$	Operating Junction Temperature Range	-55 to 150	$^\circ\text{C}$

## Thermal Characteristics

Symbol	Parameter	Typ.	Max.	Unit
$R_{\theta JA}$	Thermal Resistance Junction to ambient	---	62	$^\circ\text{C/W}$
$R_{\theta JC}$	Thermal Resistance Junction to Case	---	2.1	$^\circ\text{C/W}$

**Electrical Characteristics ( $T_J=25\text{ }^\circ\text{C}$ , unless otherwise noted)**
**Off Characteristics**

Symbol	Parameter	Conditions	Min.	Typ.	Max.	Unit
$BV_{DSS}$	Drain-Source Breakdown Voltage	$V_{GS}=0V, I_D=250\mu A$	200	---	---	V
$I_{DSS}$	Drain-Source Leakage Current	$V_{DS}=200V, V_{GS}=0V, T_J=25^\circ C$	---	---	1	$\mu A$
		$V_{DS}=160V, V_{GS}=0V, T_J=125^\circ C$	---	---	10	$\mu A$
$I_{GSS}$	Gate-Source Leakage Current	$V_{GS}=\pm 30V, V_{DS}=0V$	---	---	$\pm 100$	nA

**On Characteristics**

Symbol	Parameter	Conditions	Min.	Typ.	Max.	Unit
$R_{DS(ON)}$	Static Drain-Source On-Resistance	$V_{GS}=10V, I_D=5A$	---	0.12	0.14	$\Omega$
$V_{GS(th)}$	Gate Threshold Voltage	$V_{GS}=V_{DS}, I_D=250\mu A$	1.2	1.6	2.5	V
$g_{fs}$	Forward Transconductance	$V_{DS}=10V, I_D=3A$	---	10	---	S

**Dynamic and switching Characteristics**

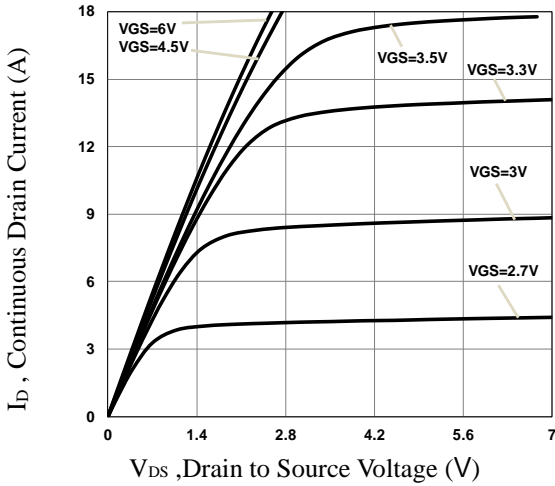
Symbol	Parameter	Conditions	Min.	Typ.	Max.	Unit
$Q_g$	Total Gate Charge <sup>3, 4</sup>	$V_{DS}=100V, V_{GS}=10V, I_D=10A$	---	21	32	nC
$Q_{gs}$	Gate-Source Charge <sup>3, 4</sup>		---	1.7	3	
$Q_{gd}$	Gate-Drain Charge <sup>3, 4</sup>		---	7.3	11	
$T_{d(on)}$	Turn-On Delay Time <sup>3, 4</sup>	$V_{DD}=100V, V_{GS}=10V, R_G=6\Omega, I_D=10A$	---	3.9	6	ns
$T_r$	Rise Time <sup>3, 4</sup>		---	12.6	19	
$T_{d(off)}$	Turn-Off Delay Time <sup>3, 4</sup>		---	23.1	35	
$T_f$	Fall Time <sup>3, 4</sup>		---	6.7	10	
$C_{iss}$	Input Capacitance	$V_{DS}=100V, V_{GS}=0V, F=1MHz$	---	800	1200	pF
$C_{oss}$	Output Capacitance		---	73	110	
$C_{rss}$	Reverse Transfer Capacitance		---	15	23	
$R_g$	Gate resistance	$V_{GS}=0V, V_{DS}=0V, F=1MHz$	---	6.5	---	$\Omega$

**Drain-Source Diode Characteristics and Maximum Ratings**

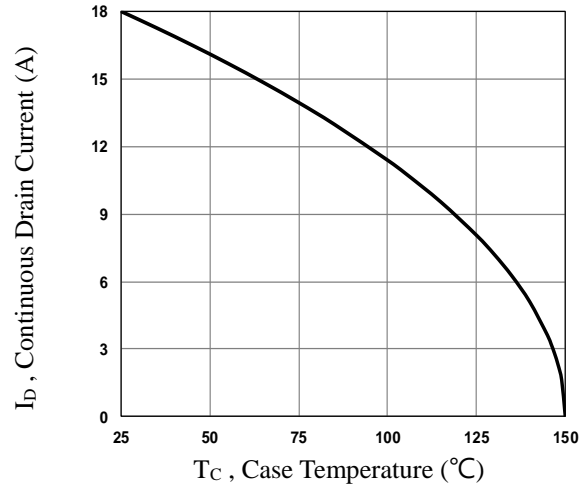
Symbol	Parameter	Conditions	Min.	Typ.	Max.	Unit
$I_S$	Continuous Source Current	$V_G=V_D=0V, \text{Force Current}$	---	---	18	A
$I_{SM}$	Pulsed Source Current		---	---	36	A
$V_{SD}$	Diode Forward Voltage	$V_{GS}=0V, I_S=1A, T_J=25^\circ C$	---	---	1	V
$t_{rr}$	Reverse Recovery Time	$V_R=200V, I_S=8A$	---	160	---	ns
$Q_{rr}$	Reverse Recovery Charge	$di/dt=100A/\mu s, T_J=25^\circ C$	---	690	---	nC

Note :

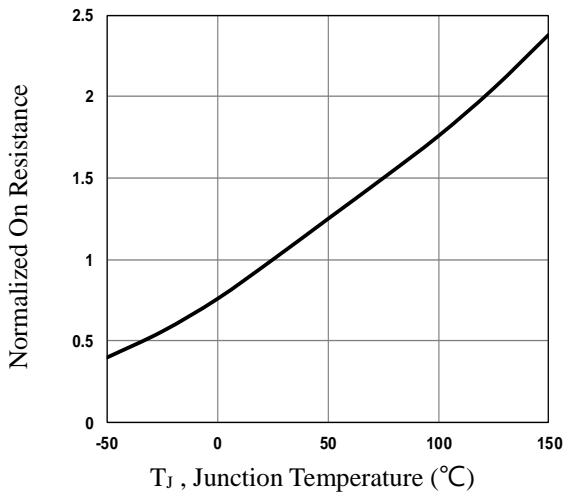
1. Repetitive Rating : Pulsed width limited by maximum junction temperature.
2.  $V_{DD}=50V, V_{GS}=10V, L=1mH, I_{AS}=27A, R_G=25\Omega, \text{Starting } T_J=25^\circ C$ .
3. The data tested by pulsed , pulse width  $\leq 300\mu s$  , duty cycle  $\leq 2\%$ .
4. Essentially independent of operating temperature.
- 5.



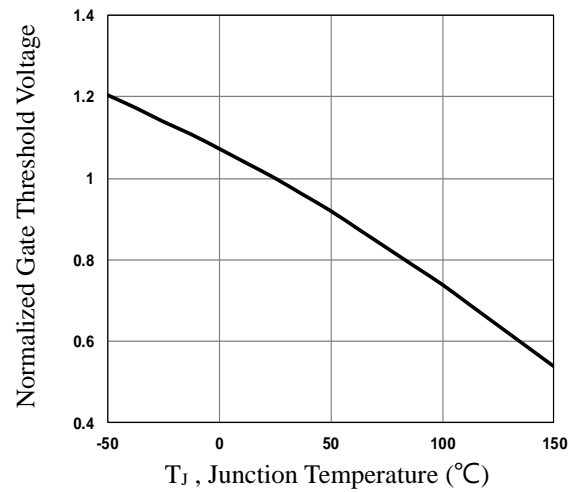
**Fig.1 Typical Output Characteristics**



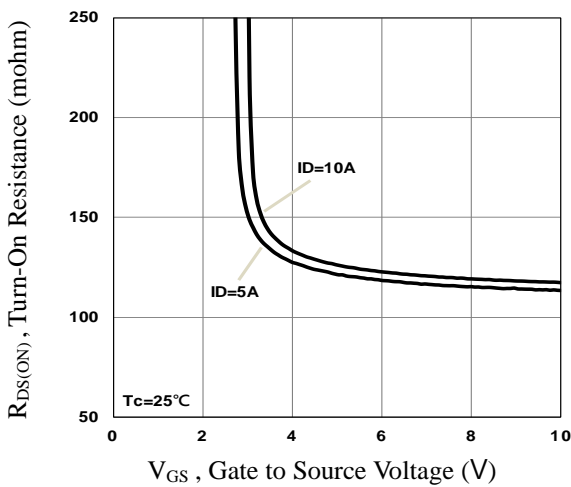
**Fig.2 Continuous Drain Current vs.  $T_c$**



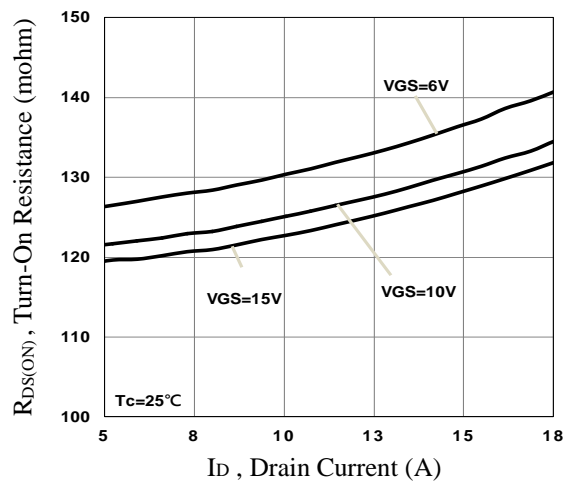
**Fig.3 Normalized  $R_{DS(on)}$  vs.  $T_J$**



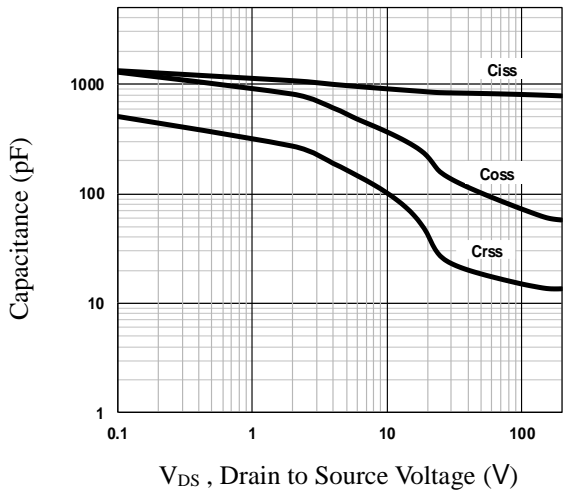
**Fig.4 Normalized  $V_{th}$  vs.  $T_J$**



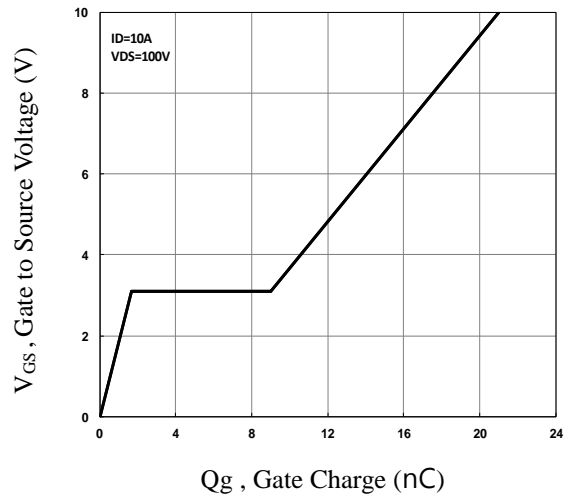
**Fig.5 Turn-On Resistance vs.  $V_{GS}$**



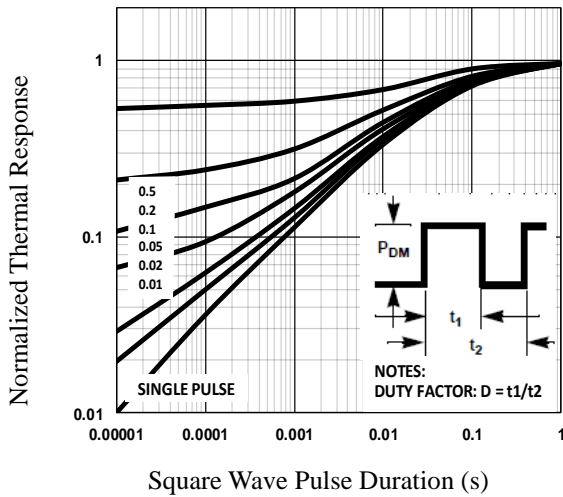
**Fig.6 Turn-On Resistance vs.  $I_D$**



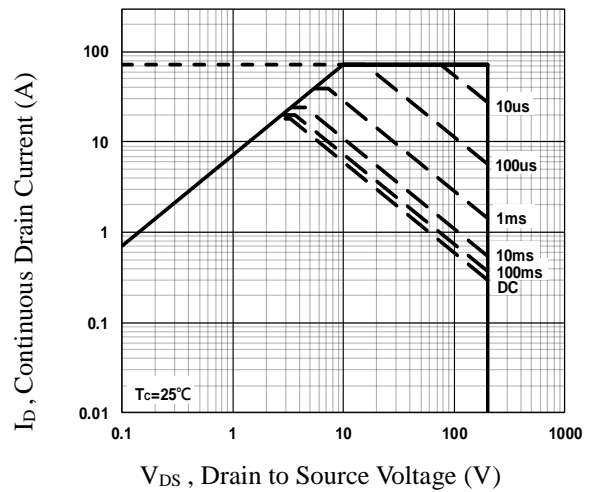
**Fig.7 Capacitance Characteristics**



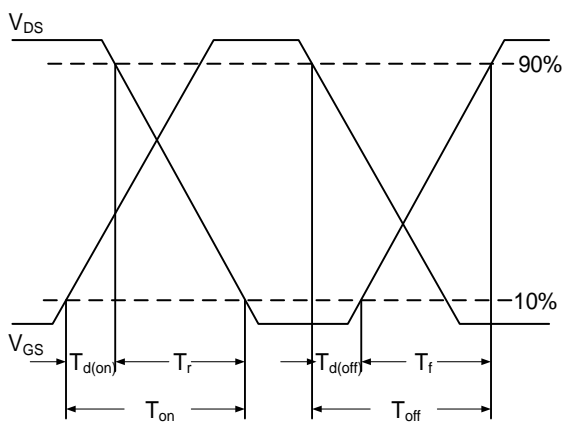
**Fig.8 Gate Charge Characteristics**



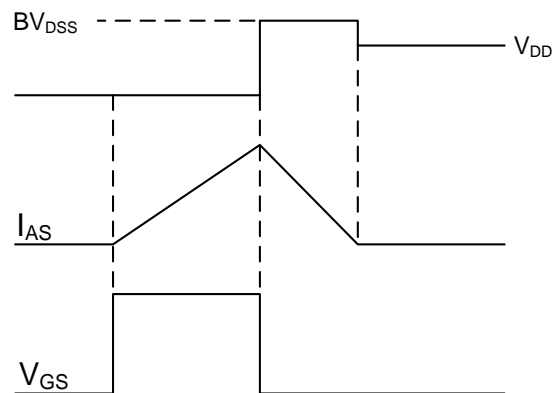
**Fig.9 Normalized Transient Impedance**



**Fig.10 Maximum Safe Operation Area**

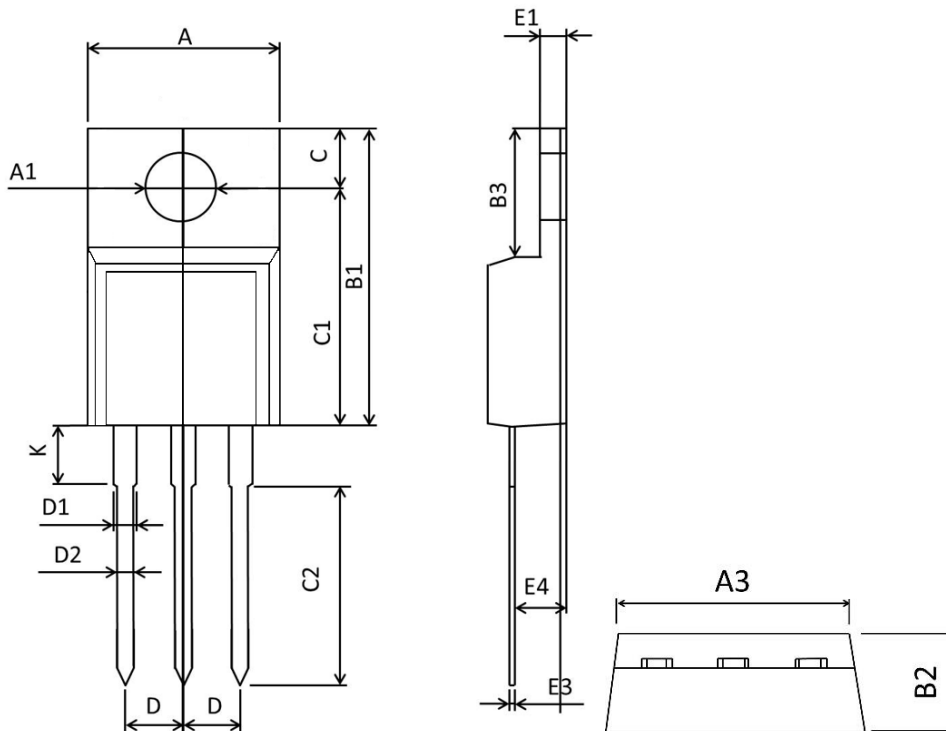


**Fig.11 Switching Time Waveform**



**Fig.12 EAS Waveform**

**TO220F PACKAGE INFORMATION**



Symbol	Dimensions In Millimeters		Dimensions In Inches	
	Min	Max	Min	Max
A	9.860	10.460	0.389	0.411
A1	3.100	3.500	0.122	0.138
B1	15.450	16.300	0.608	0.642
B2	4.400	5.000	0.173	0.197
B3	6.280	7.100	0.247	0.280
C	3.100	3.500	0.122	0.138
C1	12.270	12.870	0.483	0.507
C2	9.600	10.520	0.378	0.414
D	2.540BSC		0.1BSC	
D1	1.070	1.470	0.042	0.058
D2	0.600	1.000	0.024	0.039
K	2.800	3.500	0.110	0.138
E1	2.340	2.740	0.092	0.108
E3	0.350	0.650	0.014	0.026
E4	2.460	2.960	0.097	0.117