

General Description

These N-Channel enhancement mode power field effect transistors are using super junction MOS technology. This advanced technology has been especially tailored to minimize on-state resistance, provide superior switching performance, and withstand high energy pulse in the avalanche and commutation mode. These devices are well suited for high efficiency fast switching applications.

BVDSS	RDSON	ID
600V	70mΩ	50A

Features

- 600V,50A, $R_{DS(ON)} = 70m\Omega @ V_{GS} = 10V$
- Improved dv/dt capability
- Fast switching
- Green Device Available

TO247 Pin Configuration

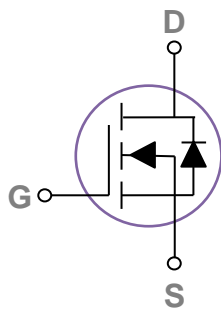
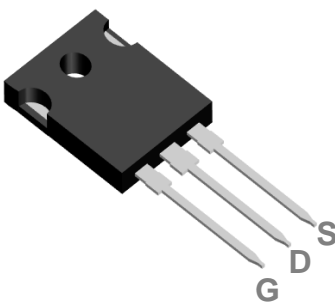

Applications

- PFC Power Supply Stages
- Motor Control
- DC-DC Converters
- Adapter

Absolute Maximum Ratings $T_c=25^\circ C$ unless otherwise noted

Symbol	Parameter	Rating	Units
V_{DS}	Drain-Source Voltage	600	V
V_{GS}	Gate-Source Voltage	± 30	V
I_D	Drain Current – Continuous ($T_c=25^\circ C$)	50	A
	Drain Current – Continuous ($T_c=100^\circ C$)	32	A
I_{DM}	Drain Current – Pulsed ¹	200	A
EAS	Single Pulse Avalanche Energy	4833	mJ
P_D	Power Dissipation ($T_c=25^\circ C$)	298	W
	Power Dissipation – Derate above 25°C	2.4	W/°C
T_{STG}	Storage Temperature Range	-55 to 150	°C
T_J	Operating Junction Temperature Range	-55 to 150	°C

Thermal Characteristics

Symbol	Parameter	Typ.	Max.	Unit
$R_{\theta JA}$	Thermal Resistance Junction to ambient	---	62	°C/W
$R_{\theta JC}$	Thermal Resistance Junction to Case	---	0.42	°C/W

Electrical Characteristics (T_J=25 °C, unless otherwise noted)
Off Characteristics

Symbol	Parameter	Conditions	Min.	Typ.	Max.	Unit
BV _{DSS}	Drain-Source Breakdown Voltage	V _{GS} =0V, I _D =1mA	600	---	---	V
I _{DSS}	Drain-Source Leakage Current	V _{DS} =600V, V _{GS} =0V, T _J =25°C	---	---	1	μA
		V _{DS} =480V, V _{GS} =0V, T _J =125°C	---	---	10	μA
I _{GSS}	Gate-Source Leakage Current	V _{GS} =±30V, V _{DS} =0V	---	---	±100	nA

On Characteristics

R _{DS(ON)}	Static Drain-Source On-Resistance	V _{GS} =10V, I _D =25A	---	60	70	mΩ
V _{GS(th)}	Gate Threshold Voltage	V _{GS} =V _{DS} , I _D =250μA	2	3	4	V

Dynamic and switching Characteristics

Q _g	Total Gate Charge ^{2,3}	V _{DS} =300V, V _{GS} =10V, I _D =25A	---	128	195	nC
Q _{gs}	Gate-Source Charge ^{2,3}		---	15	25	
Q _{gd}	Gate-Drain Charge ^{2,3}		---	47	70	
T _{d(on)}	Turn-On Delay Time ^{2,3}	V _{DS} =300V, V _{GS} =10V, R _G =25Ω I _D =25A	---	70	105	ns
T _r	Rise Time ^{2,3}		---	200	300	
T _{d(off)}	Turn-Off Delay Time ^{2,3}		---	410	615	
T _f	Fall Time ^{2,3}		---	162	245	
C _{iss}	Input Capacitance	V _{DS} =100V, V _{GS} =0V, F=1MHz	---	4350	6500	pF
C _{oss}	Output Capacitance		---	185	300	
C _{rss}	Reverse Transfer Capacitance		---	5.5	10	
R _g	Total Gate Charge ^{2,3}	V _{GS} =0V, V _{DS} =0V, F=1MHz	---	2.6	---	Ω

Guaranteed Avalanche Energy

Symbol	Parameter	Conditions	Min.	Typ.	Max.	Unit
EAS	Single Pulse Avalanche Energy	V _{DD} =100V, L=79.9mH, I _{AS} =5.5A	1208	---	---	mJ

Drain-Source Diode Characteristics and Maximum Ratings

Symbol	Parameter	Conditions	Min.	Typ.	Max.	Unit
I _S	Continuous Source Current	V _G =V _D =0V, Force Current	---	---	50	A
I _{SM}	Pulsed Source Current		---	---	100	A
V _{SD}	Diode Forward Voltage	V _{GS} =0V, I _S =25A, T _J =25°C	---	---	1.4	V
t _{rr}	Reverse Recovery Time	V _R =400V, I _S =25A	---	470	---	ns
Q _{rr}	Reverse Recovery Charge	di/dt=100A/μs, T _J =25°C	---	7.5	---	μC

Note :

1. Repetitive Rating : Pulsed width limited by maximum junction temperature.
2. The data tested by pulsed, pulse width ≤ 300μs, duty cycle ≤ 2%.
3. Essentially independent of operating temperature.

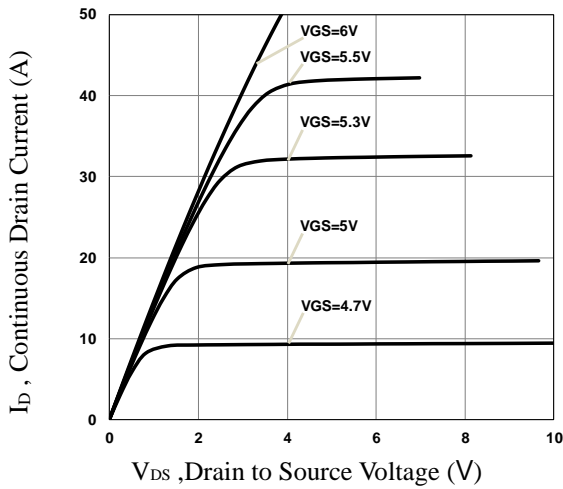

Fig.1 Typical Output Characteristics

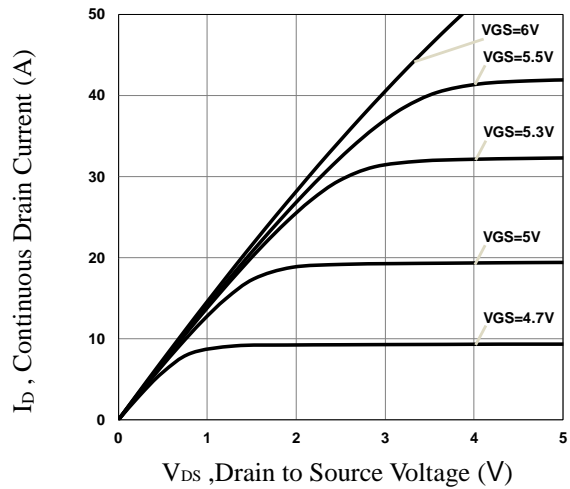

Fig.2 Typical Output Characteristics

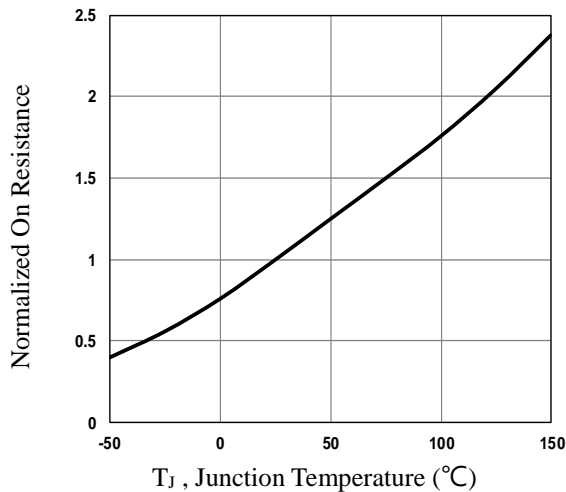

Fig.3 Normalized $R_{DS(on)}$ vs. T_J

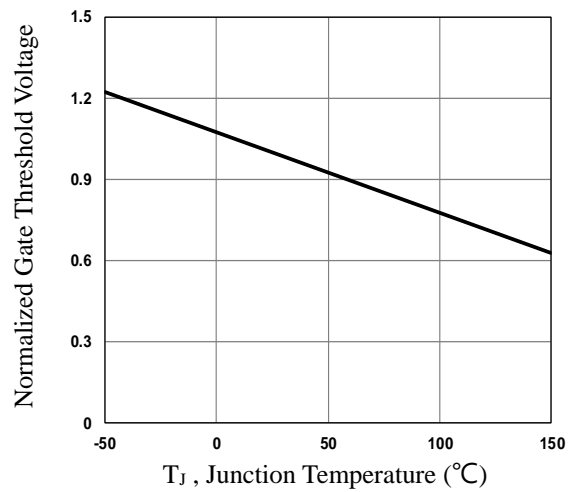

Fig.4 Normalized V_{th} vs. T_J

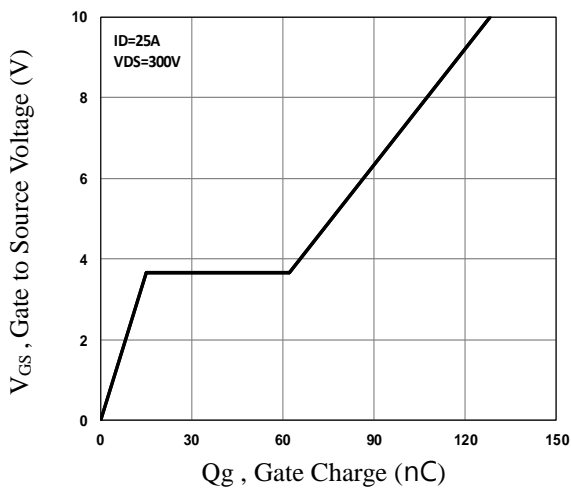

Fig.5 Gate Charge Characteristics

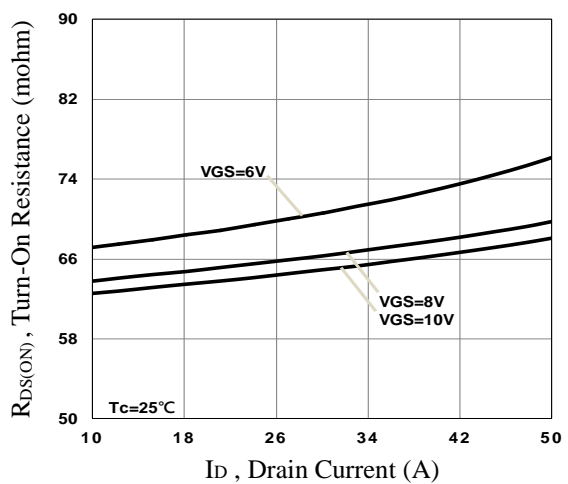

Fig.6 Turn-On Resistance vs. I_D

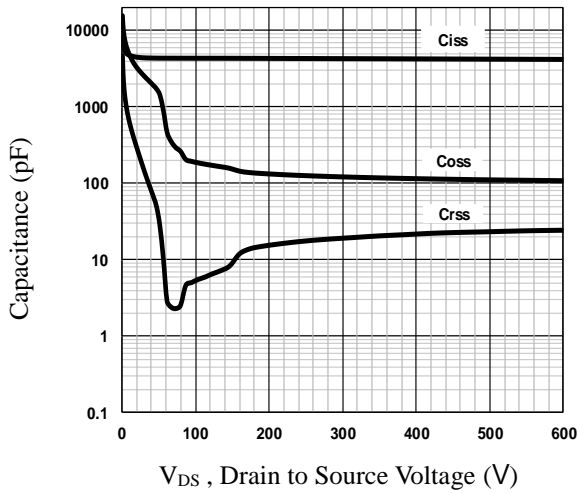

Fig.7 Capacitance Characteristics

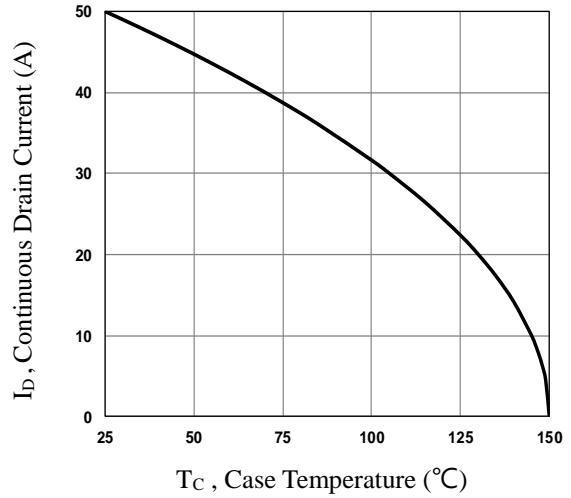

Fig.8 Continuous Drain Current vs. T_c

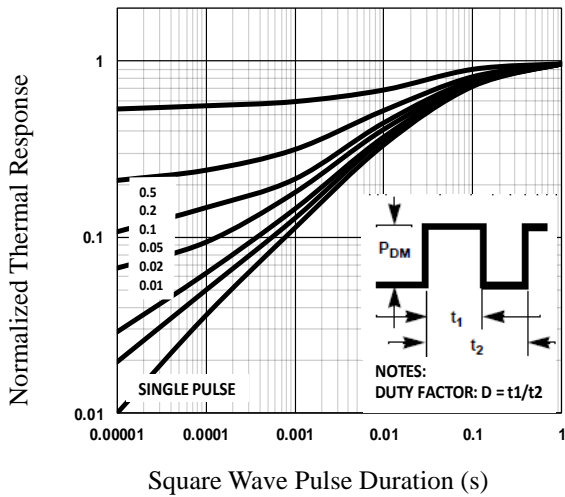

Fig.9 Normalized Transient Impedance

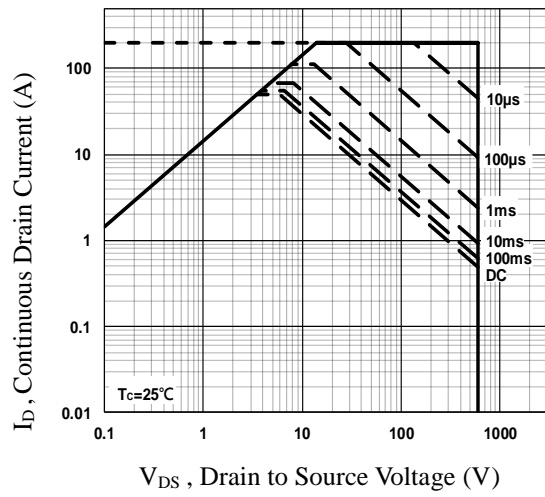

Fig.10 Maximum Safe Operation Area

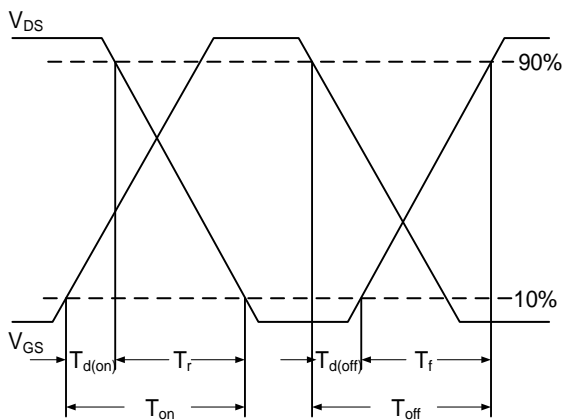

Fig.11 Switching Time Waveform

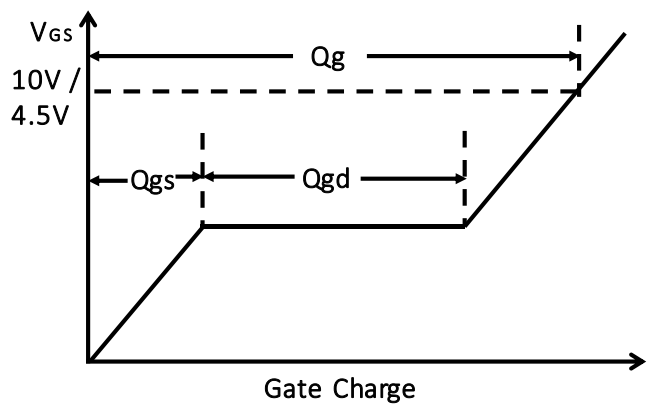
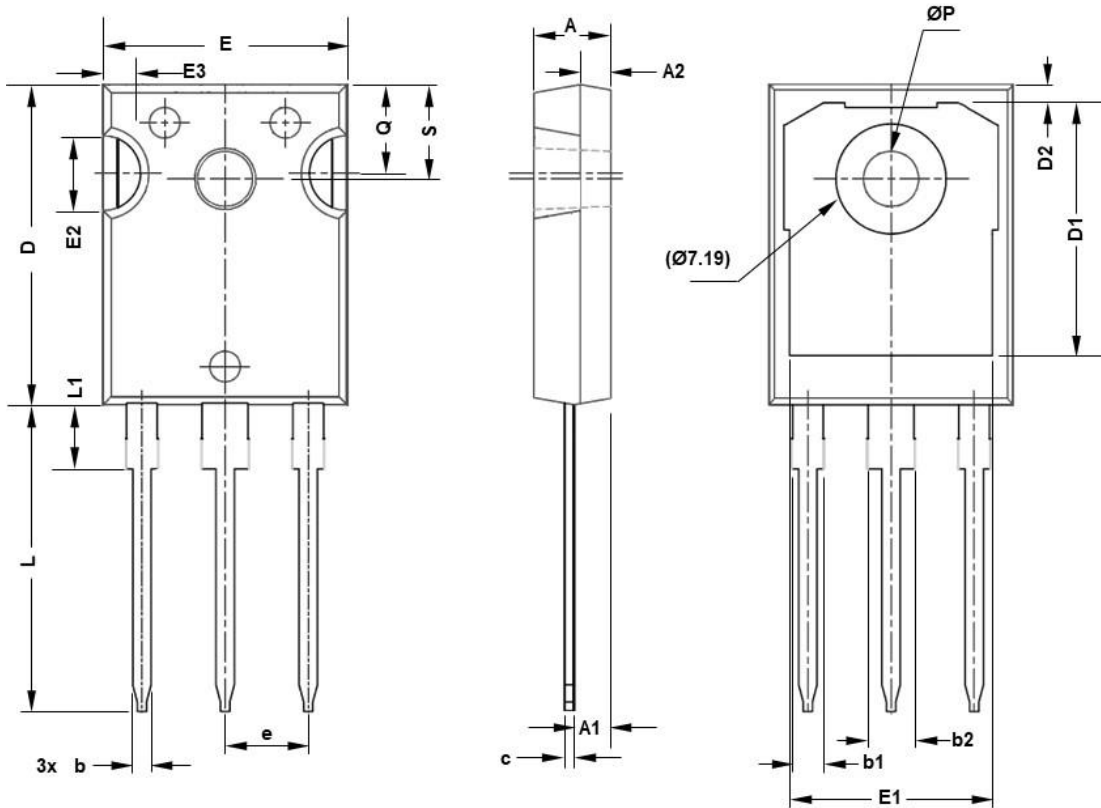

Fig.12 Gate Charge Waveform

TO247 PACKAGE INFORMATION

VERSION A



SYMBOL	mm		SYMBOL	mm	
	MIN	MAX		MIN	MAX
A	4.83	5.21	E2	4.32	5.49
A1	2.29	2.55	E3	2.15	2.80
A2	1.50	2.49	e	5.44BSC	
b	1.12	1.33	L	19.81	20.32
b1	1.91	2.39	L1	4.10	4.40
b2	2.87	3.22	ΦP	3.56	3.65
C	0.55	0.69	Q	5.39	6.20
D	20.80	21.10	S	6.04	6.30
D1	16.25	17.65			
D2	0.51	1.35			
E	15.75	16.13			
E1	13.46	14.16			

VERSION B

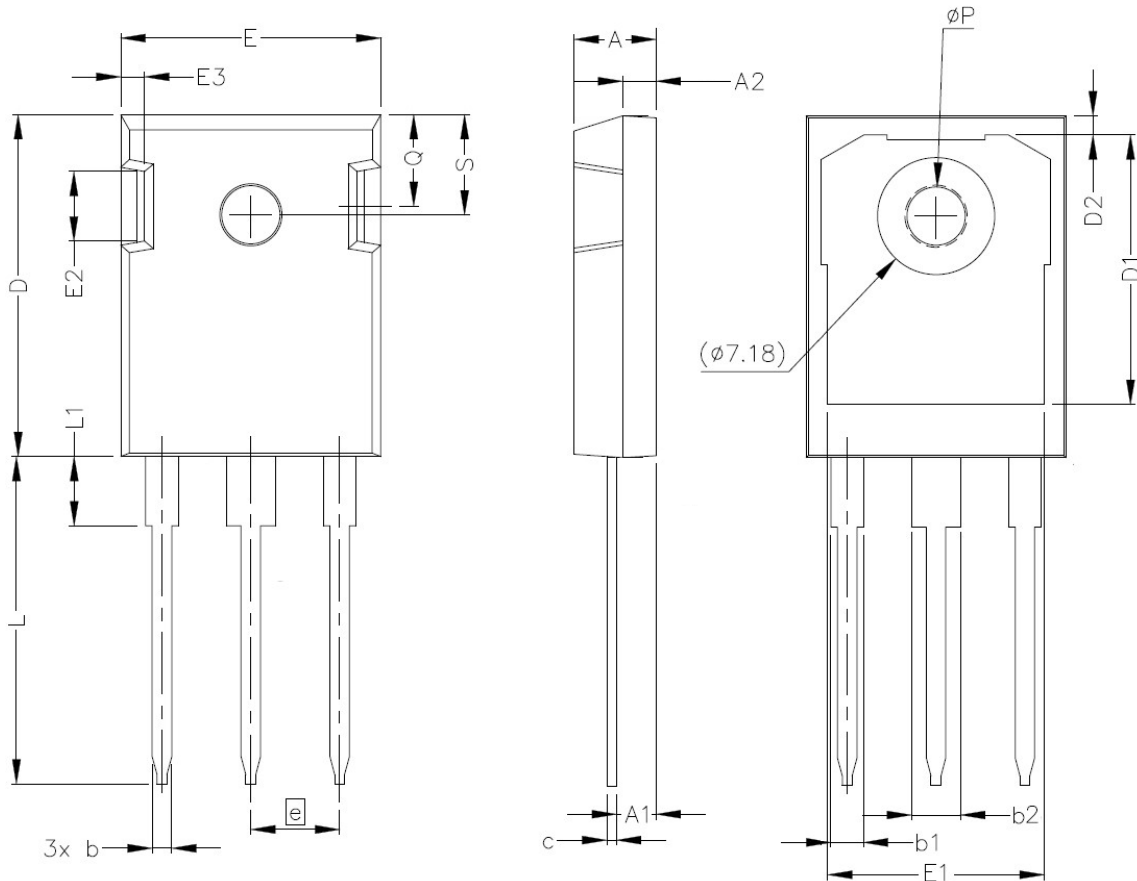

SYMBOL	mm		SYMBOL	mm	
	MIN	MAX		MIN	MAX
A	4.75	5.25	E2	3.70	5.30
A1	2.16	2.66	E3	1.00	2.75
A2	1.75	2.25	e	5.44BSC	
b	1.07	1.35	L	19.52	20.32
b1	1.90	2.41	L1	4.10	4.40
b2	2.87	3.38	ΦP	3.35	3.85
C	0.50	0.70	Q	5.40	6.20
D	20.60	21.40	S	6.15BSC	
D1	16.15	17.65			
D2	0.95	1.35			
E	15.50	16.10			
E1	12.40	13.60			