

### General Description

These N-Channel enhancement mode power field effect transistors are using super junction MOS technology. This advanced technology has been especially tailored to minimize on-state resistance, provide superior switching performance, and withstand high energy pulse in the avalanche and commutation mode. These devices are well suited for high efficiency fast switching applications.

### TO247 Pin Configuration

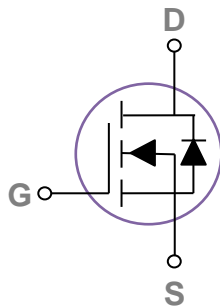
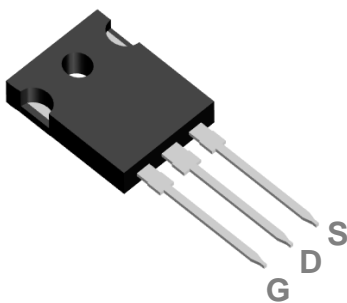

BVDSS	RDSON	ID
650V	190mΩ	20A

### Features

- 650V,20A,  $R_{DS(ON)} = 190m\Omega @ V_{GS} = 10V$
- Improved  $dv/dt$  capability
- Fast switching
- 100% EAS Guaranteed
- Green Device Available

### Applications

- PFC Power Supply Stages
- Motor Control
- DC-DC Converters
- Adapter

### Absolute Maximum Ratings $T_c=25^\circ C$ unless otherwise noted

Symbol	Parameter	Rating	Units
$V_{DS}$	Drain-Source Voltage	650	V
$V_{GS}$	Gate-Source Voltage	$\pm 30$	V
$I_D$	Drain Current – Continuous ( $T_c=25^\circ C$ )	20	A
	Drain Current – Continuous ( $T_c=100^\circ C$ )	12.5	A
$I_{DM}$	Drain Current – Pulsed <sup>1</sup>	80	A
EAS	Single Pulse Avalanche Energy	420	mJ
$P_D$	Power Dissipation ( $T_c=25^\circ C$ )	180	W
	Power Dissipation – Derate above $25^\circ C$	1.44	W/ $^\circ C$
$T_{STG}$	Storage Temperature Range	-55 to 150	$^\circ C$
$T_J$	Operating Junction Temperature Range	-55 to 150	$^\circ C$

### Thermal Characteristics

Symbol	Parameter	Typ.	Max.	Unit
$R_{\theta JA}$	Thermal Resistance Junction to ambient	---	62	$^\circ C/W$
$R_{\theta JC}$	Thermal Resistance Junction to Case	---	0.69	$^\circ C/W$

**Electrical Characteristics (T<sub>J</sub>=25 °C, unless otherwise noted)**
**Off Characteristics**

Symbol	Parameter	Conditions	Min.	Typ.	Max.	Unit
BV <sub>DSS</sub>	Drain-Source Breakdown Voltage	V <sub>GS</sub> =0V, I <sub>D</sub> =1mA	650	---	---	V
I <sub>DSS</sub>	Drain-Source Leakage Current	V <sub>DS</sub> =650V, V <sub>GS</sub> =0V, T <sub>J</sub> =25°C	---	---	1	μA
		V <sub>DS</sub> =520V, V <sub>GS</sub> =0V, T <sub>J</sub> =125°C	---	---	10	μA
I <sub>GSS</sub>	Gate-Source Leakage Current	V <sub>GS</sub> =±30V, V <sub>DS</sub> =0V	---	---	±100	nA

**On Characteristics**

R <sub>DS(ON)</sub>	Static Drain-Source On-Resistance	V <sub>GS</sub> =10V, I <sub>D</sub> =10A	---	160	190	mΩ
V <sub>GS(th)</sub>	Gate Threshold Voltage	V <sub>GS</sub> =V <sub>DS</sub> , I <sub>D</sub> =250μA	2	3	4	V

**Dynamic and switching Characteristics**

Q <sub>g</sub>	Total Gate Charge <sup>2,3</sup>	V <sub>DS</sub> =480V, V <sub>GS</sub> =10V, I <sub>D</sub> =10A	---	47	70	nC
Q <sub>gs</sub>	Gate-Source Charge <sup>2,3</sup>		---	5	8	
Q <sub>gd</sub>	Gate-Drain Charge <sup>2,3</sup>		---	14	21	
T <sub>d(on)</sub>	Turn-On Delay Time <sup>2,3</sup>	V <sub>DS</sub> =480V, V <sub>GS</sub> =10V, R <sub>G</sub> =25Ω I <sub>D</sub> =10A	---	32	48	ns
T <sub>r</sub>	Rise Time <sup>2,3</sup>		---	73	110	
T <sub>d(off)</sub>	Turn-Off Delay Time <sup>2,3</sup>		---	146	220	
T <sub>f</sub>	Fall Time <sup>2,3</sup>		---	47	70	
C <sub>iss</sub>	Input Capacitance	V <sub>DS</sub> =100V, V <sub>GS</sub> =0V, F=1MHz	---	1400	2100	pF
C <sub>oss</sub>	Output Capacitance		---	55	85	
C <sub>rss</sub>	Reverse Transfer Capacitance		---	1.3	4.6	
R <sub>g</sub>	Total Gate Charge <sup>2,3</sup>	V <sub>GS</sub> =0V, V <sub>DS</sub> =0V, F=1MHz	---	8	---	Ω

**Drain-Source Diode Characteristics and Maximum Ratings**

Symbol	Parameter	Conditions	Min.	Typ.	Max.	Unit
I <sub>S</sub>	Continuous Source Current	V <sub>G</sub> =V <sub>D</sub> =0V, Force Current	---	---	20	A
I <sub>SM</sub>	Pulsed Source Current		---	---	40	A
V <sub>SD</sub>	Diode Forward Voltage	V <sub>GS</sub> =0V, I <sub>S</sub> =10A, T <sub>J</sub> =25°C	---	---	1.4	V
t <sub>rr</sub>	Reverse Recovery Time	V <sub>R</sub> =400V, I <sub>S</sub> =10A	---	310	---	ns
Q <sub>rr</sub>	Reverse Recovery Charge	di/dt=100A/μs, T <sub>J</sub> =25°C	---	4.4	---	μC

Note :

1. Repetitive Rating : Pulsed width limited by maximum junction temperature.
2. The data tested by pulsed , pulse width ≤ 300us , duty cycle ≤ 2%.
3. Essentially independent of operating temperature.

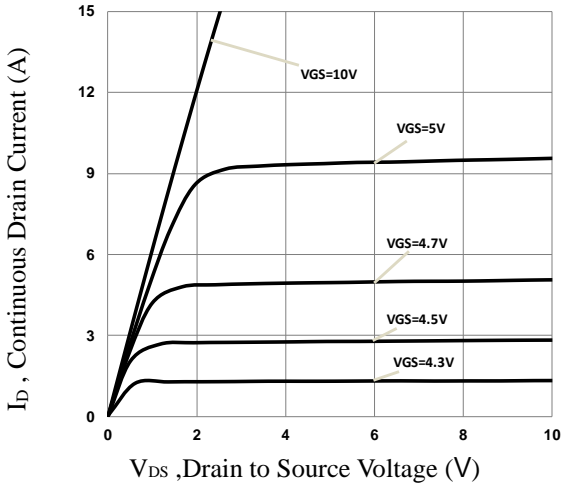

**Fig.1 Typical Output Characteristics**

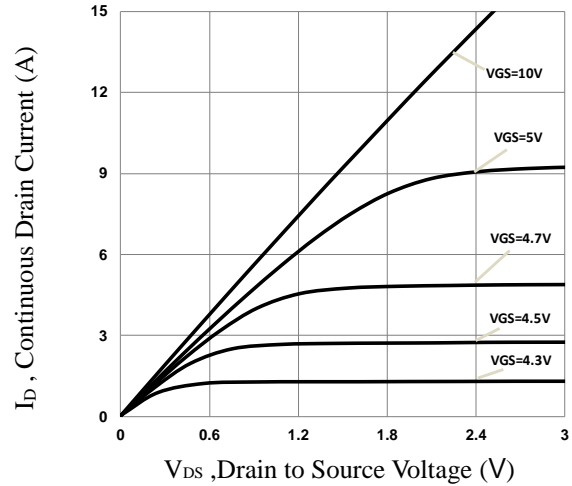

**Fig.2 Typical Output Characteristics**

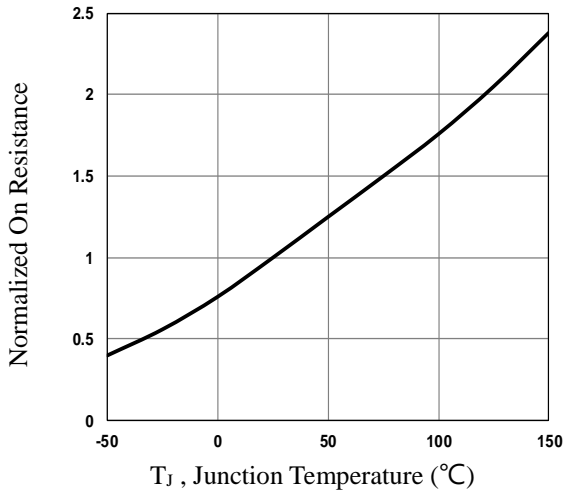

**Fig.3 Normalized  $R_{DS(on)}$  vs.  $T_J$**

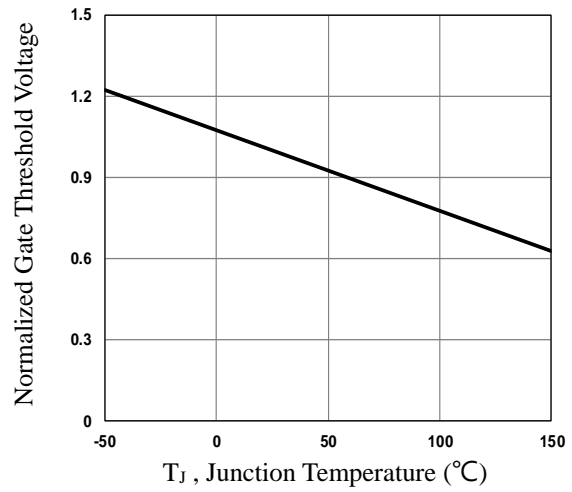

**Fig.4 Normalized  $V_{th}$  vs.  $T_J$**

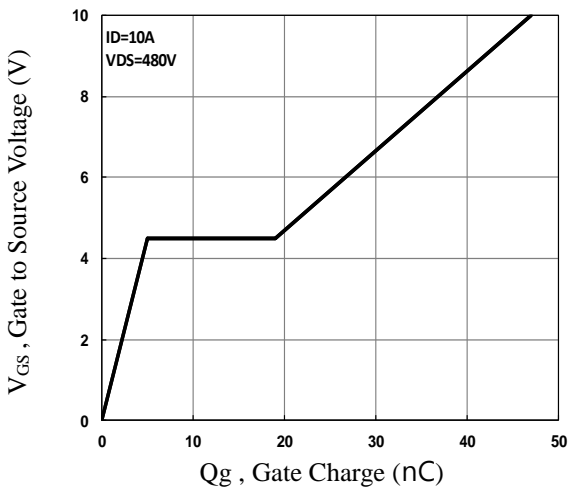

**Fig.5 Gate Charge Characteristics**

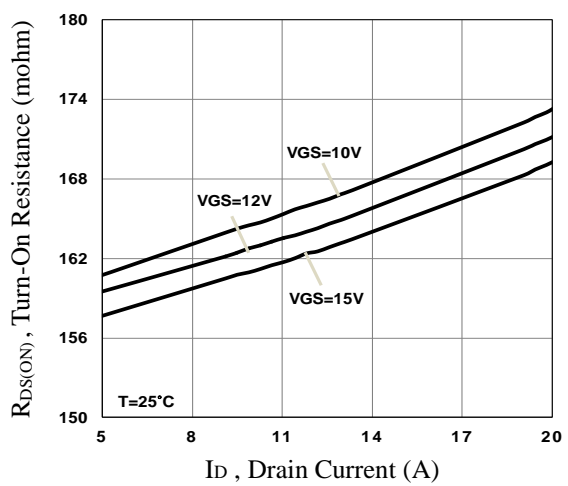

**Fig.6 Turn-On Resistance vs.  $I_D$**

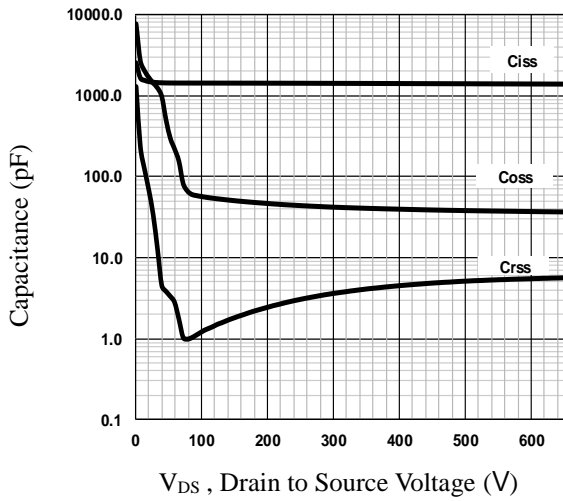

**Fig.7 Capacitance Characteristics**

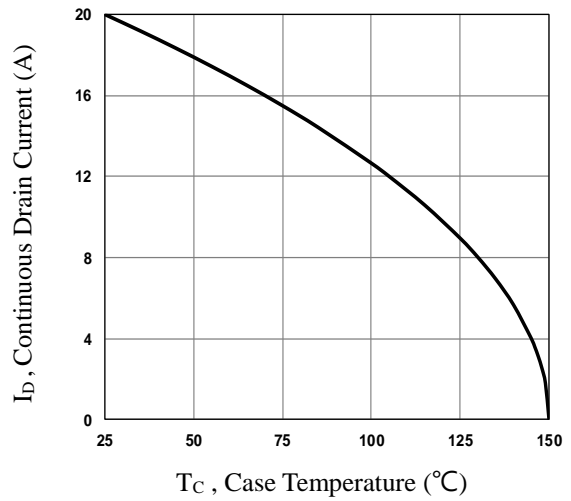

**Fig.8 Continuous Drain Current vs. T<sub>c</sub>**

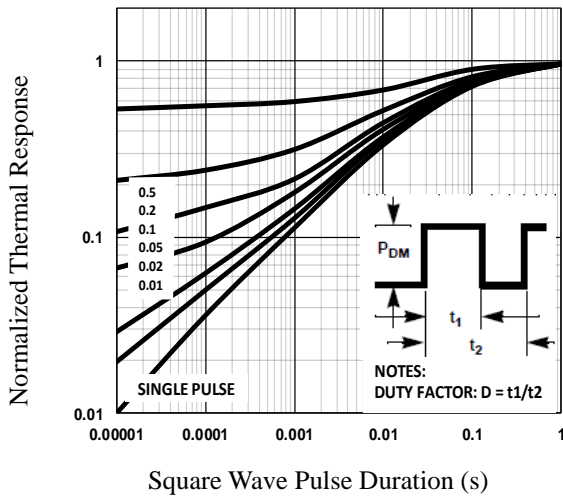

**Fig.9 Normalized Transient Impedance**

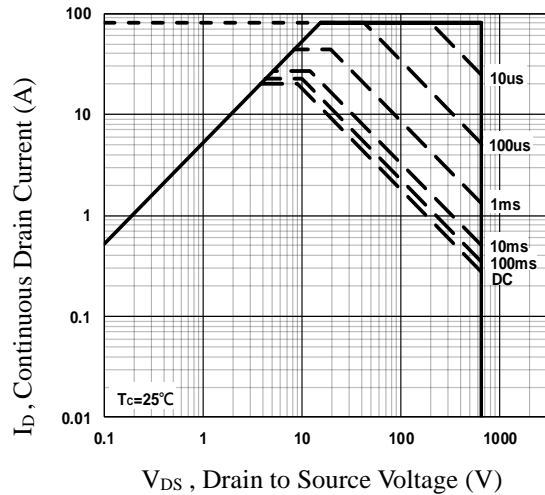

**Fig.10 Maximum Safe Operation Area**

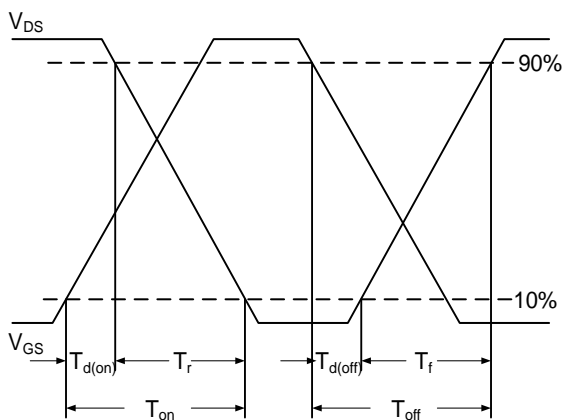

**Fig.11 Switching Time Waveform**

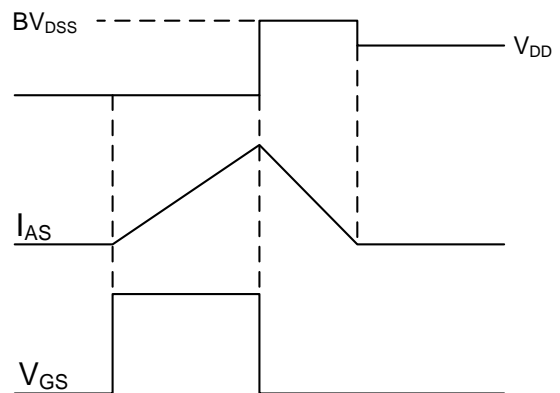

**Fig.12 EAS Waveform**

**TO247 PACKAGE INFORMATION**

**VERSION A**

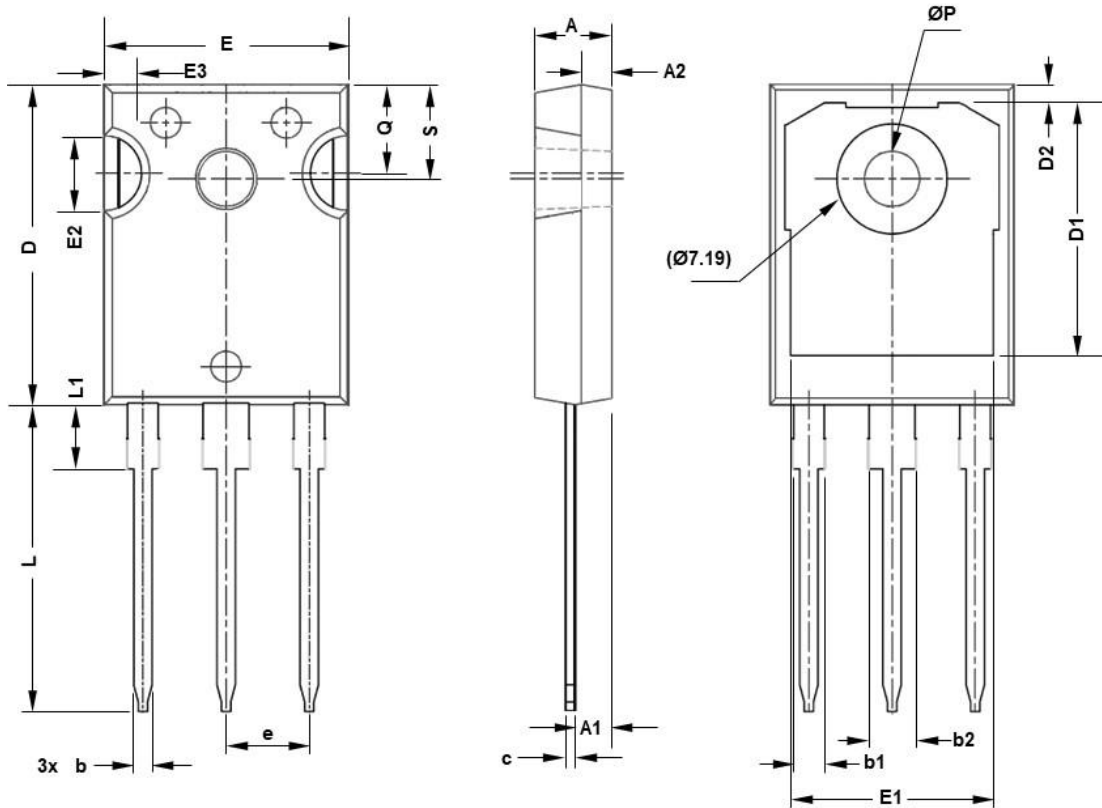

SYMBOL	mm		SYMBOL	mm	
	MIN	MAX		MIN	MAX
A	4.83	5.21	E2	4.32	5.49
A1	2.29	2.55	E3	2.15	2.80
A2	1.50	2.49	e	5.44BSC	
b	1.12	1.33	L	19.81	20.32
b1	1.91	2.39	L1	4.10	4.40
b2	2.87	3.22	ΦP	3.56	3.65
C	0.55	0.69	Q	5.39	6.20
D	20.80	21.10	S	6.04	6.30
D1	16.25	17.65			
D2	0.51	1.35			
E	15.75	16.13			
E1	13.46	14.16			

VERSION B

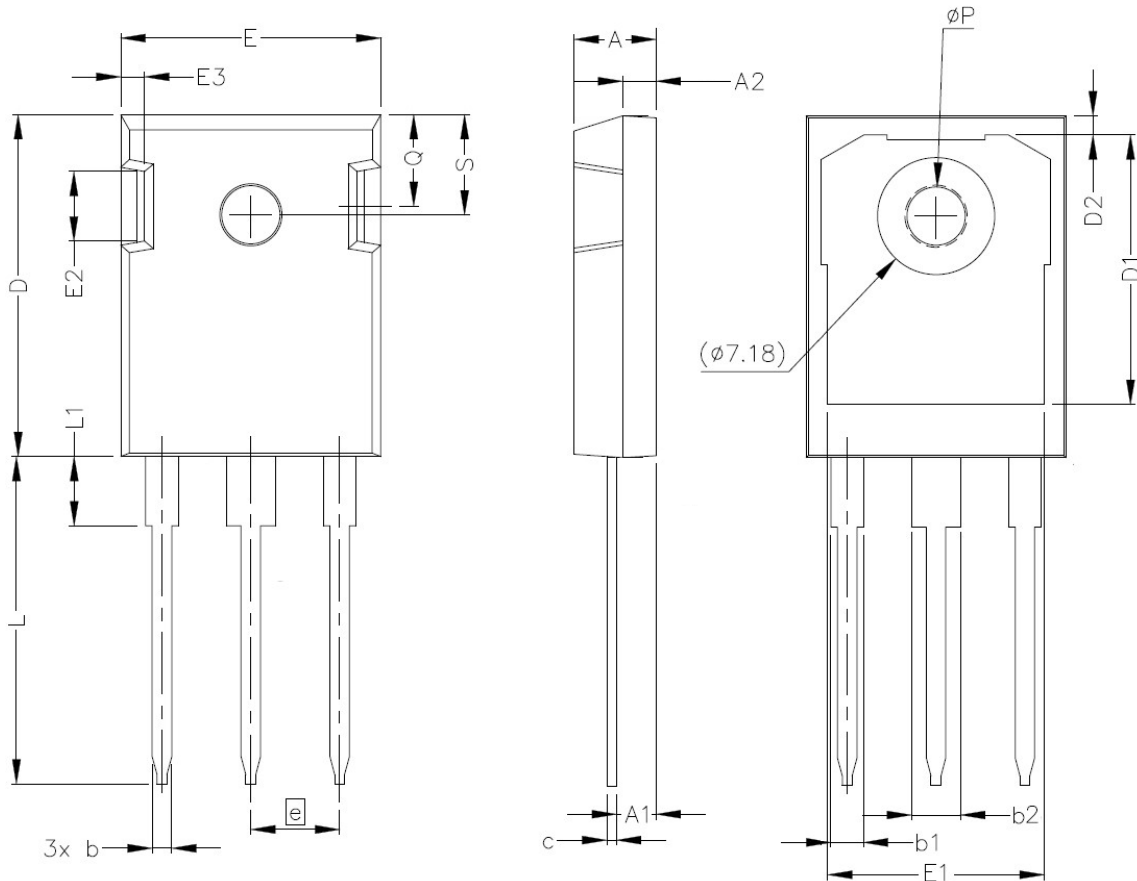

SYMBOL	mm		SYMBOL	mm	
	MIN	MAX		MIN	MAX
A	4.75	5.25	E2	3.70	5.30
A1	2.16	2.66	E3	1.00	2.75
A2	1.75	2.25	e	5.44BSC	
b	1.07	1.35	L	19.52	20.32
b1	1.90	2.41	L1	4.10	4.40
b2	2.87	3.38	ΦP	3.35	3.85
C	0.50	0.70	Q	5.40	6.20
D	20.60	21.40	S	6.15BSC	
D1	16.15	17.65			
D2	0.95	1.35			
E	15.50	16.10			
E1	12.40	13.60			