

General Description

These N-Channel enhancement mode power field effect transistors are using super junction MOS technology. This advanced technology has been especially tailored to minimize on-state resistance, provide superior switching performance, and withstand high energy pulse in the avalanche and commutation mode. These devices are well suited for high efficiency fast switching applications.

TO220F Pin Configuration

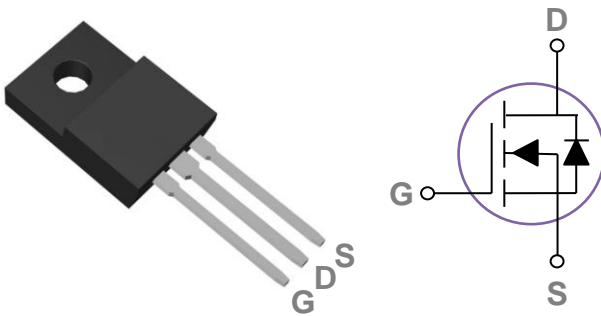

BVDSS	RDSON	ID
600V	115mΩ	30A

Features

- 600V,30A, $R_{DS(ON)} = 115m\Omega @ V_{GS} = 10V$
- Improved dv/dt capability
- Fast switching
- 100% EAS Guaranteed
- Green Device Available

Applications

- PFC Power Supply Stages
- Motor Control
- DC-DC Converters
- Adapter

Absolute Maximum Ratings $T_c=25^\circ C$ unless otherwise noted

Symbol	Parameter	Rating	Units
V_{DS}	Drain-Source Voltage	600	V
V_{GS}	Gate-Source Voltage	± 30	V
I_D	Drain Current – Continuous ($T_c=25^\circ C$)	30	A
	Drain Current – Continuous ($T_c=100^\circ C$)	19	A
I_{DM}	Drain Current – Pulsed ¹	120	A
EAS	Single Pulse Avalanche Energy	700	mJ
P_D	Power Dissipation ($T_c=25^\circ C$)	53	W
	Power Dissipation – Derate above $25^\circ C$	0.43	W/ $^\circ C$
T_{STG}	Storage Temperature Range	-55 to 150	$^\circ C$
T_J	Operating Junction Temperature Range	-55 to 150	$^\circ C$

Thermal Characteristics

Symbol	Parameter	Typ.	Max.	Unit
$R_{\theta JA}$	Thermal Resistance Junction to ambient	---	62	$^\circ C/W$
$R_{\theta JC}$	Thermal Resistance Junction to Case	---	2.35	$^\circ C/W$

Electrical Characteristics (T_J=25 °C, unless otherwise noted)
Off Characteristics

Symbol	Parameter	Conditions	Min.	Typ.	Max.	Unit
BV _{DSS}	Drain-Source Breakdown Voltage	V _{GS} =0V, I _D =1mA	600	---	---	V
I _{DSS}	Drain-Source Leakage Current	V _{DS} =600V, V _{GS} =0V, T _J =25°C	---	---	1	μA
		V _{DS} =480V, V _{GS} =0V, T _J =125°C	---	---	10	μA
I _{GSS}	Gate-Source Leakage Current	V _{GS} =±30V, V _{DS} =0V	---	---	±100	nA

On Characteristics

R _{DS(ON)}	Static Drain-Source On-Resistance	V _{GS} =10V, I _D =15A	---	100	115	mΩ
V _{GS(th)}	Gate Threshold Voltage	V _{GS} =V _{DS} , I _D =250μA	2	3	4	V

Dynamic and switching Characteristics

Q _g	Total Gate Charge ^{2,3}	V _{DS} =480V, V _{GS} =10V, I _D =15A	---	88	135	nC
Q _{gs}	Gate-Source Charge ^{2,3}		---	10	15	
Q _{gd}	Gate-Drain Charge ^{2,3}		---	37	60	
T _{d(on)}	Turn-On Delay Time ^{2,3}	V _{DS} =480V, V _{GS} =10V, R _G =25Ω I _D =15A	---	50	75	ns
T _r	Rise Time ^{2,3}		---	110	165	
T _{d(off)}	Turn-Off Delay Time ^{2,3}		---	250	375	
T _f	Fall Time ^{2,3}		---	90	135	
C _{iss}	Input Capacitance	V _{DS} =100V, V _{GS} =0V, F=1MHz	---	2580	3900	pF
C _{oss}	Output Capacitance		---	115	175	
C _{rss}	Reverse Transfer Capacitance		---	15	25	
R _g	Total Gate Charge ^{2,3}	V _{GS} =0V, V _{DS} =0V, F=1MHz	---	3	---	Ω

Drain-Source Diode Characteristics and Maximum Ratings

Symbol	Parameter	Conditions	Min.	Typ.	Max.	Unit
I _S	Continuous Source Current	V _G =V _D =0V, Force Current	---	---	30	A
I _{SM}	Pulsed Source Current		---	---	60	A
V _{SD}	Diode Forward Voltage	V _{GS} =0V, I _S =15A, T _J =25°C	---	---	1.4	V
t _{rr}	Reverse Recovery Time	V _R =400V, I _S =10A	---	370	---	ns
Q _{rr}	Reverse Recovery Charge	di/dt=100A/μs, T _J =25°C	---	5.2	---	μC

Note :

1. Repetitive Rating : Pulsed width limited by maximum junction temperature.
2. The data tested by pulsed , pulse width ≤ 300us , duty cycle ≤ 2%.
3. Essentially independent of operating temperature.

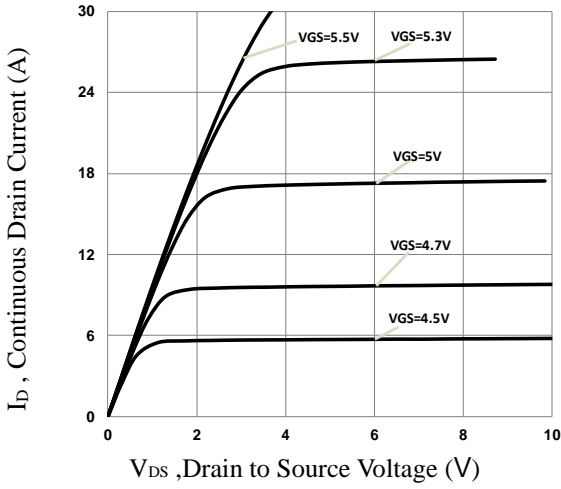

Fig.1 Typical Output Characteristics

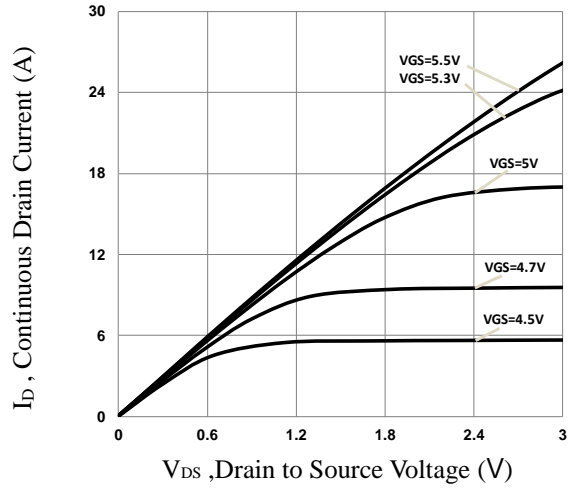

Fig.2 Typical Output Characteristics

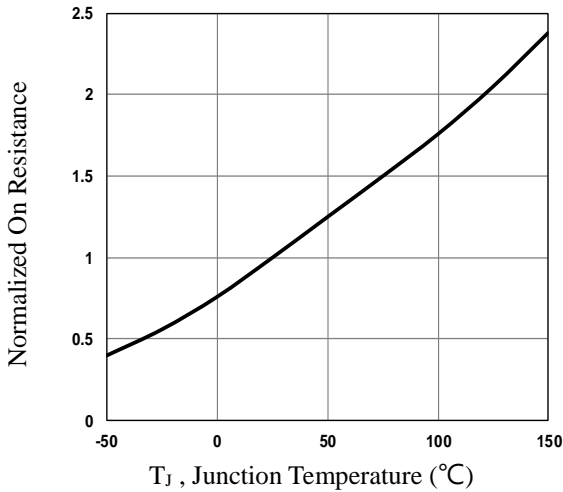

Fig.3 Normalized $R_{DS(on)}$ vs. T_J

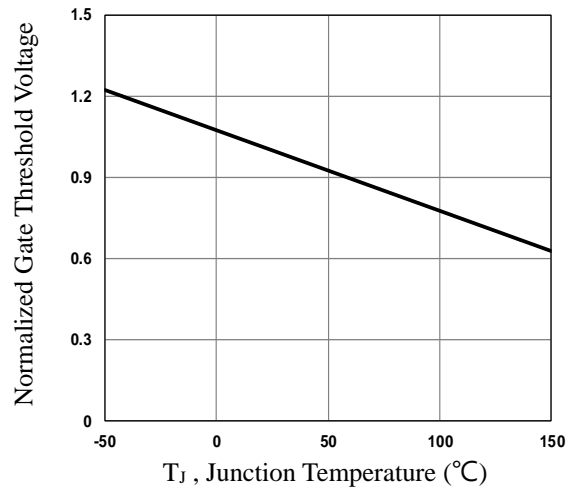

Fig.4 Normalized V_{th} vs. T_J

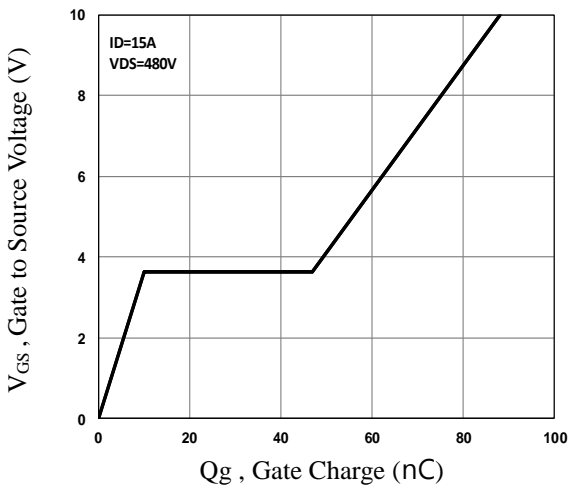

Fig.5 Gate Charge Characteristics

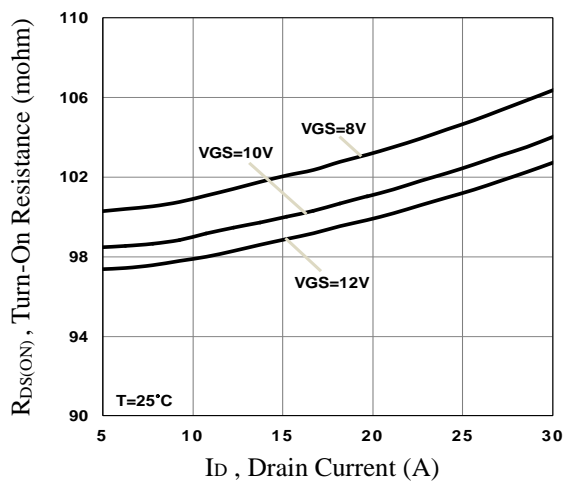

Fig.6 Turn-On Resistance vs. I_D

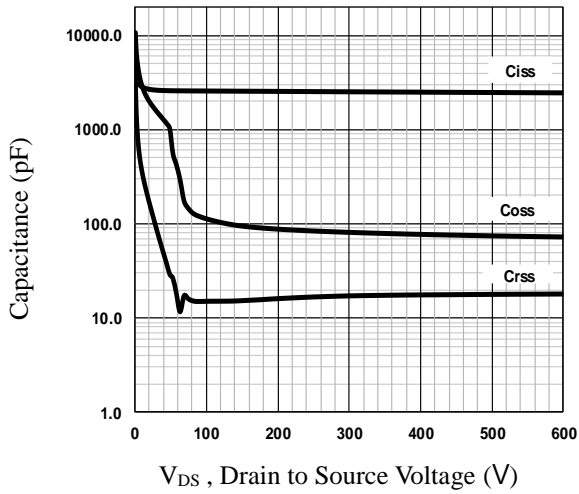

Fig.7 Capacitance Characteristics

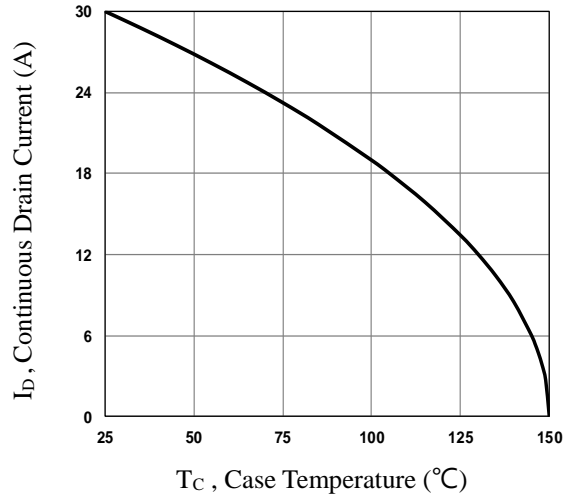

Fig.8 Continuous Drain Current vs. T_c

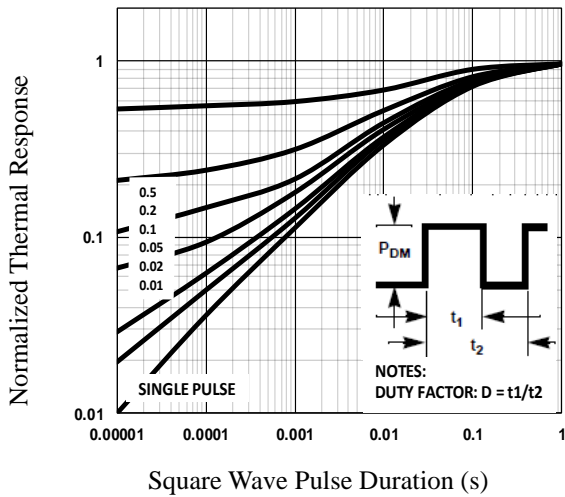

Fig.9 Normalized Transient Impedance

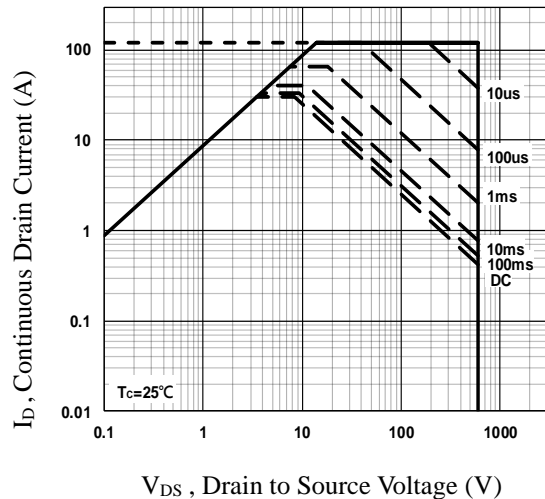

Fig.10 Maximum Safe Operation Area

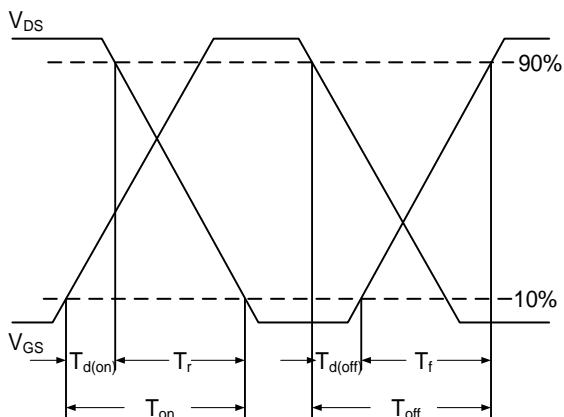

Fig.11 Switching Time Waveform

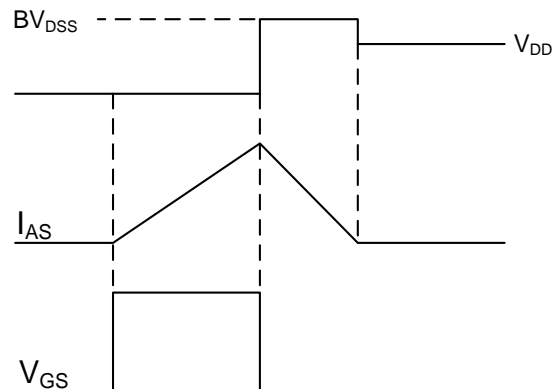
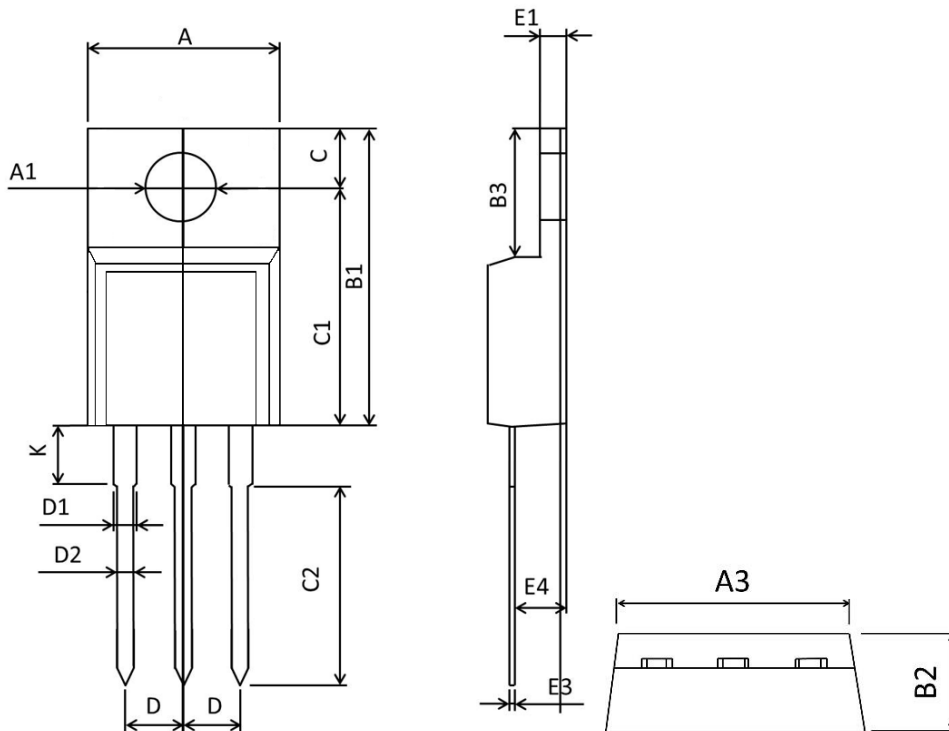

Fig.12 EAS Waveform

TO220F PACKAGE INFORMATION



Symbol	Dimensions In Millimeters		Dimensions In Inches	
	Min	Max	Min	Max
A	9.860	10.460	0.389	0.411
A1	3.100	3.500	0.122	0.138
B1	15.450	16.300	0.608	0.642
B2	4.400	5.000	0.173	0.197
B3	6.280	7.100	0.247	0.280
C	3.100	3.500	0.122	0.138
C1	12.270	12.870	0.483	0.507
C2	9.600	10.520	0.378	0.414
D	2.540BSC		0.1BSC	
D1	1.070	1.470	0.042	0.058
D2	0.600	1.000	0.024	0.039
K	2.800	3.500	0.110	0.138
E1	2.340	2.740	0.092	0.108
E3	0.350	0.650	0.014	0.026
E4	2.460	2.960	0.097	0.117