

General Description

These N-Channel enhancement mode power field effect transistors are using trench DMOS technology. This advanced technology has been especially tailored to minimize on-state resistance, provide superior switching performance, and withstand high energy pulse in the avalanche and commutation mode. These devices are well suited for high efficiency fast switching applications.

BVDSS	RDSON	ID
100V	85mΩ	20A

Features

- 100V,20A, $R_{DS(ON)} = 85m\Omega @ V_{GS} = 10V$
- Improved dv/dt capability
- Fast switching
- 100% EAS Guaranteed
- Green Device Available

TO220 Pin Configuration

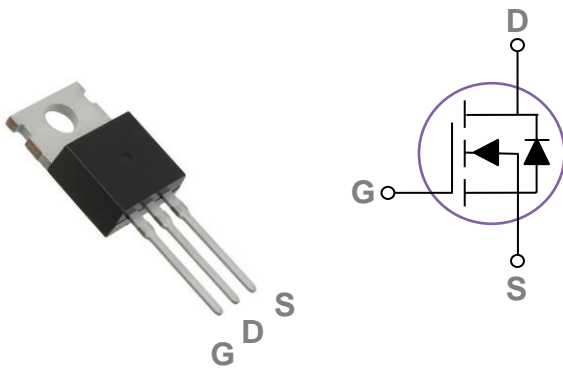

Applications

- Networking
- Load Switch
- LED applications

Absolute Maximum Ratings $T_c=25^\circ\text{C}$ unless otherwise noted

Symbol	Parameter	Rating	Units
V_{DS}	Drain-Source Voltage	100	V
V_{GS}	Gate-Source Voltage	± 20	V
I_D	Drain Current – Continuous ($T_c=25^\circ\text{C}$)	20	A
	Drain Current – Continuous ($T_c=100^\circ\text{C}$)	13	A
I_{DM}	Drain Current – Pulsed ¹	80	A
EAS	Single Pulse Avalanche Energy ⁴	18	mJ
IAS	Single Pulse Avalanche Current ⁴	19	A
P_D	Power Dissipation ($T_c=25^\circ\text{C}$)	74	W
	Power Dissipation – Derate above 25°C	.58	W/ $^\circ\text{C}$
T_{STG}	Storage Temperature Range	-50 to 150	$^\circ\text{C}$
T_J	Operating Junction Temperature Range	-50 to 150	$^\circ\text{C}$

Thermal Characteristics

Symbol	Parameter	Typ.	Max.	Unit
$R_{\theta JA}$	Thermal Resistance Junction to ambient	---	62	$^\circ\text{C}/\text{W}$
$R_{\theta JC}$	Thermal Resistance Junction to Case	---	1.7	$^\circ\text{C}/\text{W}$

Electrical Characteristics (T_J=25 °C, unless otherwise noted)
Off Characteristics

Symbol	Parameter	Conditions	Min.	Typ.	Max.	Unit
BV _{DSS}	Drain-Source Breakdown Voltage	V _{GS} =0V, I _D =250μA	100	---	---	V
I _{DSS}	Drain-Source Leakage Current	V _{DS} =100V, V _{GS} =0V, T _J =25°C	---	---	1	μA
		V _{DS} =80V, V _{GS} =0V, T _J =125°C	---	---	10	μA
I _{GSS}	Gate-Source Leakage Current	V _{GS} =±20V, V _{DS} =0V	---	---	±100	nA

On Characteristics

Symbol	Parameter	Conditions	Min.	Typ.	Max.	Unit
R _{DS(ON)}	Static Drain-Source On-Resistance	V _{GS} =10V, I _D =6A	---	65	85	mΩ
V _{GS(th)}	Gate Threshold Voltage	V _{GS} =V _{DS} , I _D =250μA	2	3	4	V
g _{fs}	Forward Transconductance	V _{DS} =10V, I _D =3A	---	6	---	S

Dynamic and switching Characteristics

Symbol	Parameter	Conditions	Min.	Typ.	Max.	Unit
Q _g	Total Gate Charge ^{2,3}	V _{DS} =50V, V _{GS} =10V, I _D =6A	---	10.5	20	nC
Q _{gs}	Gate-Source Charge ^{2,3}		---	4.8	9	
Q _{gd}	Gate-Drain Charge ^{2,3}		---	2.9	6	
T _{d(on)}	Turn-On Delay Time ^{2,3}	V _{DD} =50V, V _{GS} =10V, R _G =25Ω I _D =1A	---	73	140	ns
T _r	Rise Time ^{2,3}		---	36	72	
T _{d(off)}	Turn-Off Delay Time ^{2,3}		---	124	240	
T _f	Fall Time ^{2,3}		---	25	50	
C _{iss}	Input Capacitance	V _{DS} =50V, V _{GS} =0V, F=1MHz	---	615	1200	pF
C _{oss}	Output Capacitance		---	47	80	
C _{rss}	Reverse Transfer Capacitance		---	29	60	
R _g	Gate resistance	V _{GS} =0V, V _{DS} =0V, F=1MHz	---	2.1	4	Ω

Drain-Source Diode Characteristics and Maximum Ratings

Symbol	Parameter	Conditions	Min.	Typ.	Max.	Unit
I _S	Continuous Source Current	V _G =V _D =0V, Force Current	---	---	20	A
I _{SM}	Pulsed Source Current		---	---	40	A
V _{SD}	Diode Forward Voltage	V _{GS} =0V, I _S =1A, T _J =25°C	---	---	1	V
t _{rr}	Reverse Recovery Time ²	I _S =1A, di/dt=100A/μs, T _J =25°C	---	18.5	---	ns
Q _{rr}	Reverse Recovery Charge ²		---	16	---	nC

Note :

1. Repetitive Rating : Pulsed width limited by maximum junction temperature.
2. The data tested by pulsed, pulse width ≤ 300μs, duty cycle ≤ 2%.
3. Essentially independent of operating temperature.
4. V_{DD}=50V, V_{GS}=10V, L=0.1mH, I_{AS}=19A, R_G=25Ω, Starting T_J=25°C.

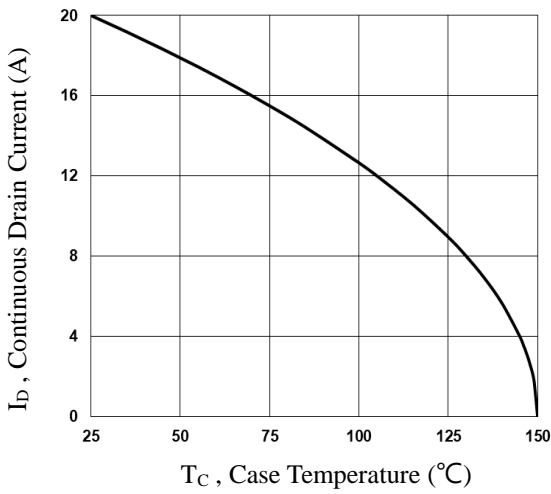

Fig.1 Continuous Drain Current vs. TC

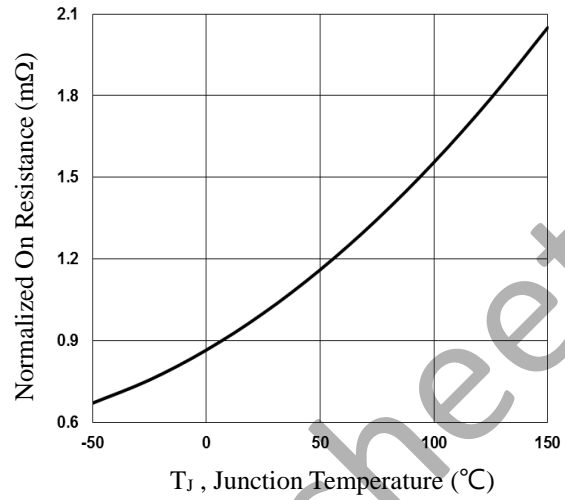

Fig.2 Normalized RDSON vs. TJ

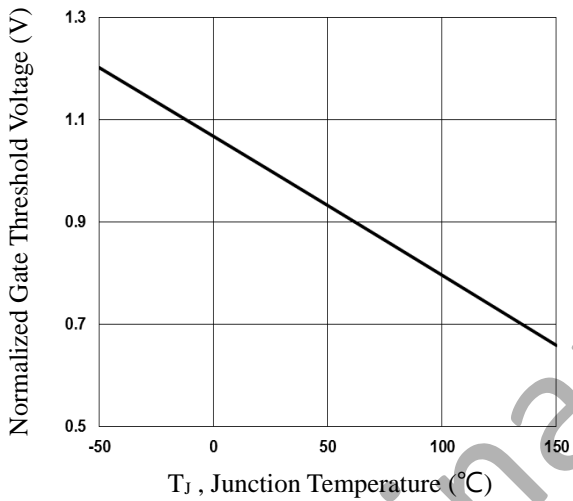

Fig.3 Normalized V_{th} vs. TJ

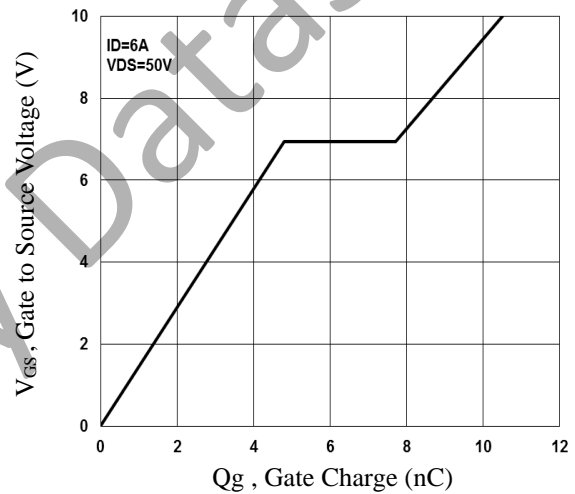

Fig.4 Gate Charge Characteristics

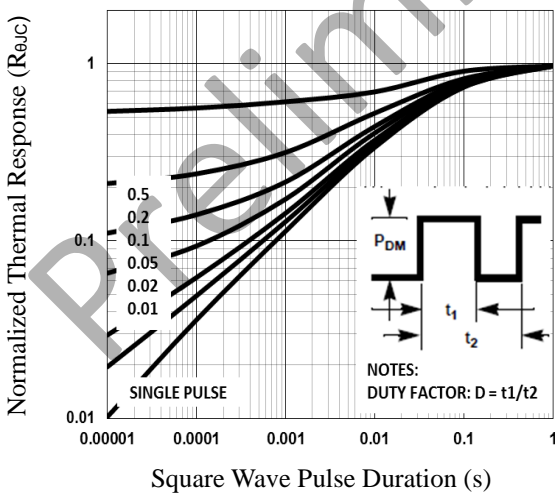

Fig.5 Normalized Transient Impedance

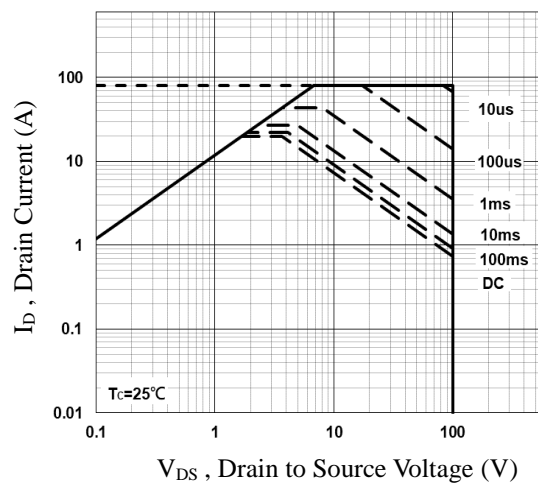

Fig.6 Maximum Safe Operation Area

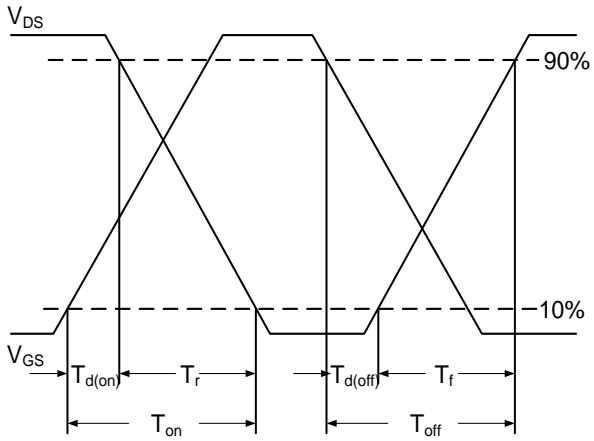

Fig.7 Switching Time Waveform

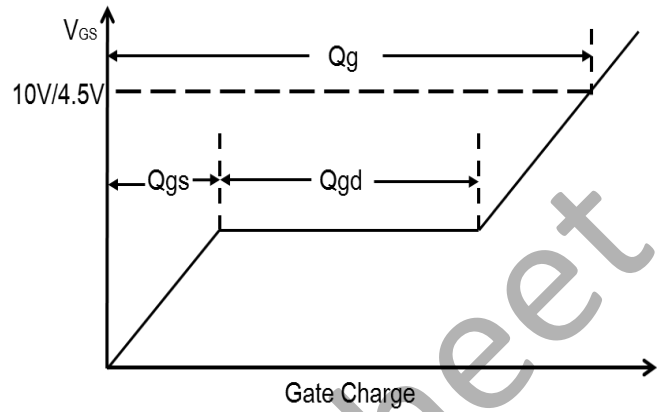
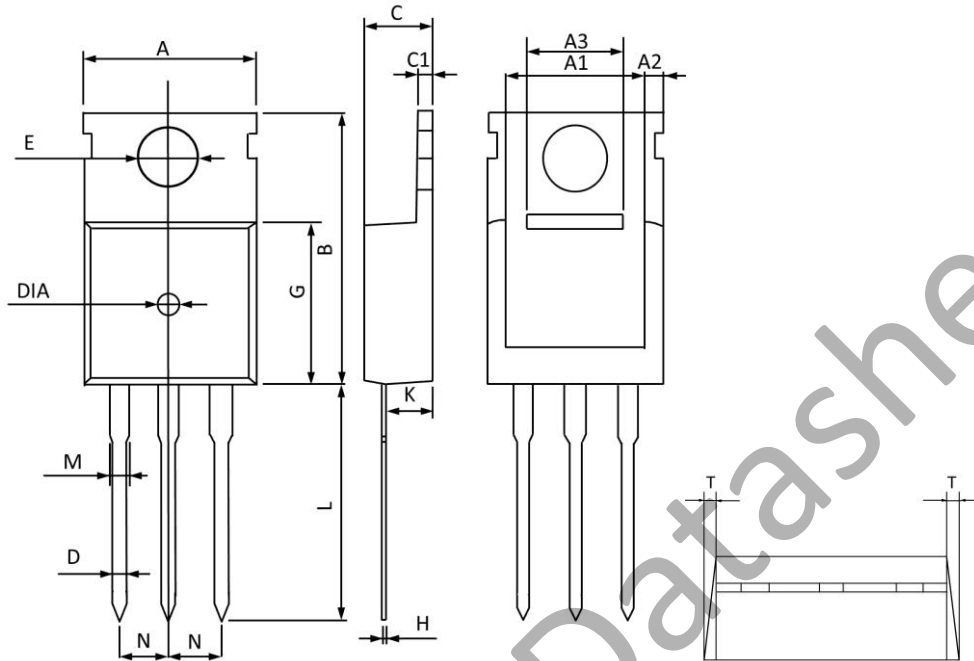

Fig.8 Gate Charge Waveform

Preliminary Datasheet

TO220 PACKAGE INFORMATION



Symbol	Dimensions In Millimeters		Dimensions In Inches	
	MAX	MIN	MAX	MIN
A	10.300	9.700	0.406	0.382
A1	8.840	8.440	0.348	0.332
A2	1.250	1.050	0.049	0.041
A3	5.300	5.100	0.209	0.201
B	16.200	15.400	0.638	0.606
C	4.680	4.280	0.184	0.169
C1	1.500	1.100	0.059	0.043
D	1.000	0.600	0.039	0.024
E	3.800	3.400	0.150	0.134
G	9.300	8.700	0.366	0.343
H	0.600	0.400	0.024	0.016
K	2.700	2.100	0.106	0.083
L	13.600	12.800	0.535	0.504
M	1.500	1.100	0.059	0.043
N	2.590	2.490	0.102	0.098
T	W0.35		W0.014	
DIA	Φ1.5 TYP.	deep0.2 TYP.	Φ0.059 TYP.	deep0.008 TYP.