

General Description

These P-Channel enhancement mode power field effect transistors are using trench DMOS technology. This advanced technology has been especially tailored to minimize on-state resistance, provide superior switching performance, and withstand high energy pulse in the avalanche and commutation mode. These devices are well suited for high efficiency fast switching applications.

SOT23-3S Pin Configuration

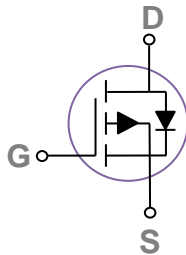
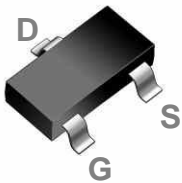

BVDSS	RDSON	ID
-20V	65mΩ	-4.1A

Features

- -20V, -4.1A, $R_{DS(ON)} = 65m\Omega @ V_{GS} = -4.5V$
- Improved dv/dt capability
- Fast switching
- Green Device Available
- Suit for -1.8V Gate Drive Applications

Applications

- Notebook
- Load Switch
- Hand-Held Instruments

Absolute Maximum Ratings $T_c=25^\circ\text{C}$ unless otherwise noted

Symbol	Parameter	Rating	Units
V_{DS}	Drain-Source Voltage	-20	V
V_{GS}	Gate-Source Voltage	± 10	V
I_D	Drain Current – Continuous ($T_A=25^\circ\text{C}$)	-4.1	A
	Drain Current – Continuous ($T_A=70^\circ\text{C}$)	-3.3	A
I_{DM}	Drain Current – Pulsed ¹	-16.4	A
P_D	Power Dissipation ($T_A=25^\circ\text{C}$)	1.56	W
	Power Dissipation – Derate above 25°C	0.012	W/ $^\circ\text{C}$
T_{STG}	Storage Temperature Range	-55 to 150	$^\circ\text{C}$
T_J	Operating Junction Temperature Range	-55 to 150	$^\circ\text{C}$

Thermal Characteristics

Symbol	Parameter	Typ.	Max.	Unit
$R_{\theta JA}$	Thermal Resistance Junction to ambient	---	80	$^\circ\text{C}/\text{W}$

Electrical Characteristics (T_J=25 °C, unless otherwise noted)
Off Characteristics

Symbol	Parameter	Conditions	Min.	Typ.	Max.	Unit
BV _{DSS}	Drain-Source Breakdown Voltage	V _{GS} =0V, I _D =-250uA	-20	---	---	V
ΔBV _{DSS} /ΔT _J	BV _{DSS} Temperature Coefficient	Reference to 25°C, I _D =-1mA	---	-0.02	---	V/°C
I _{DSS}	Drain-Source Leakage Current	V _{DS} =-20V, V _{GS} =0V, T _J =25°C	---	---	-1	uA
		V _{DS} =-16V, V _{GS} =0V, T _J =125°C	---	---	-10	uA
I _{GSS}	Gate-Source Leakage Current	V _{GS} =±10V, V _{DS} =0V	---	---	±100	nA

On Characteristics

R _{DS(ON)}	Static Drain-Source On-Resistance	V _{GS} =-4.5V, I _D =-3A	---	52	65	mΩ
		V _{GS} =-2.5V, I _D =-2A	---	73	85	
		V _{GS} =-1.8V, I _D =-1.5A	---	105	130	
V _{GS(th)}	Gate Threshold Voltage	V _{GS} =V _{DS} , I _D =-250uA	-0.4	-0.6	-0.8	V
ΔV _{GS(th)}	V _{GS(th)} Temperature Coefficient		---	2	---	mV/°C
g _{fs}	Forward Transconductance	V _{DS} =-10V, I _S =-3A	---	5.5	---	S

Dynamic and switching Characteristics

Q _g	Total Gate Charge ^{2, 3}	V _{DS} =-10V, V _{GS} =-4.5V, I _D =-3A	---	6.4	9	nC
Q _{gs}	Gate-Source Charge ^{2, 3}		---	0.9	1	
Q _{gd}	Gate-Drain Charge ^{2, 3}		---	1.6	3	
T _{d(on)}	Turn-On Delay Time ^{2, 3}	V _{DD} =-10V, V _{GS} =-4.5V, R _G =25Ω I _D =-1A	---	5	9	nS
T _r	Rise Time ^{2, 3}		---	17.4	33	
T _{d(off)}	Turn-Off Delay Time ^{2, 3}		---	40.7	80	
T _f	Fall Time ^{2, 3}		---	11.4	23	
C _{iss}	Input Capacitance	V _{DS} =-10V, V _{GS} =0V, F=1MHz	---	515	745	pF
C _{oss}	Output Capacitance		---	55	80	
C _{riss}	Reverse Transfer Capacitance		---	20	30	

Drain-Source Diode Characteristics and Maximum Ratings

Symbol	Parameter	Conditions	Min.	Typ.	Max.	Unit
I _S	Continuous Source Current	V _G =V _D =0V, Force Current	---	---	-4.1	A
I _{SM}	Pulsed Source Current		---	---	-8.2	A
V _{SD}	Diode Forward Voltage	V _{GS} =0V, I _S =-1A, T _J =25°C	---	---	-1	V

Note :

1. Repetitive Rating : Pulsed width limited by maximum junction temperature.
2. The data tested by pulsed, pulse width ≤ 300us, duty cycle ≤ 2%.
3. Essentially independent of operating temperature.

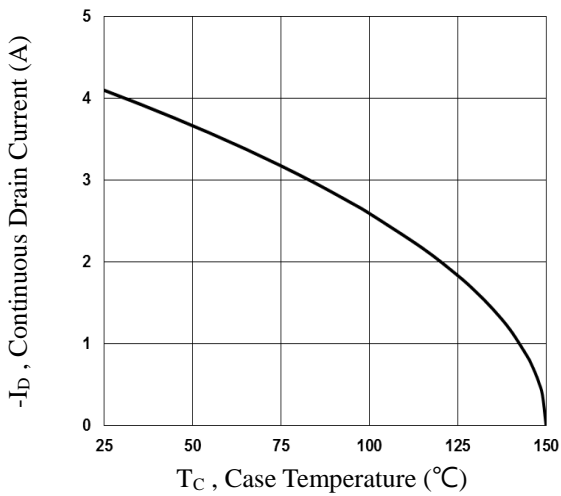

Fig.1 Continuous Drain Current vs. T_C

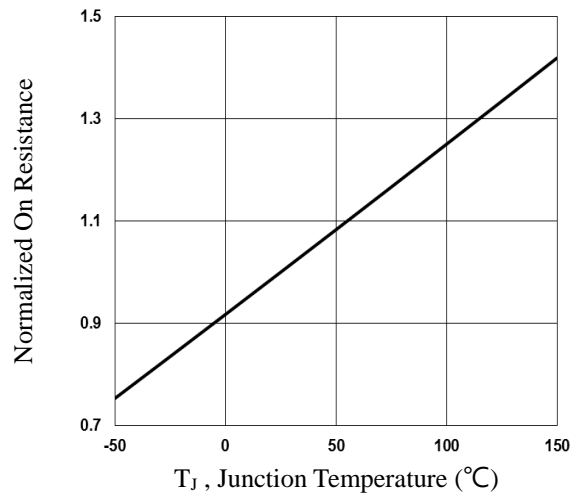

Fig.2 Normalized $R_{DS(on)}$ vs. T_J

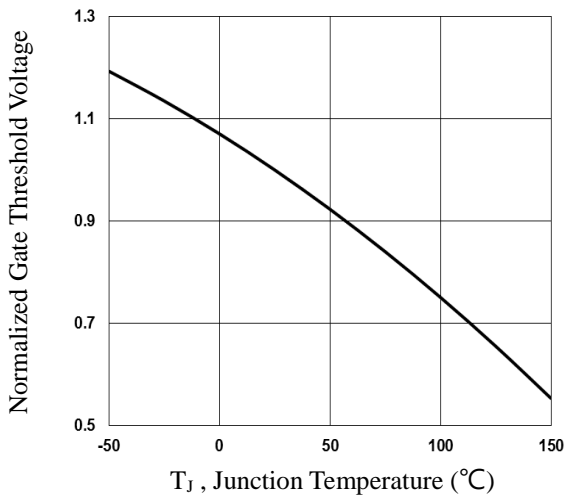

Fig.3 Normalized V_{th} vs. T_J

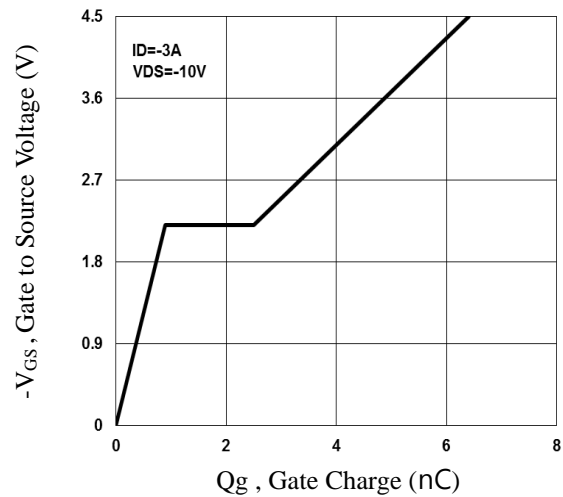

Fig.4 Gate Charge Waveform

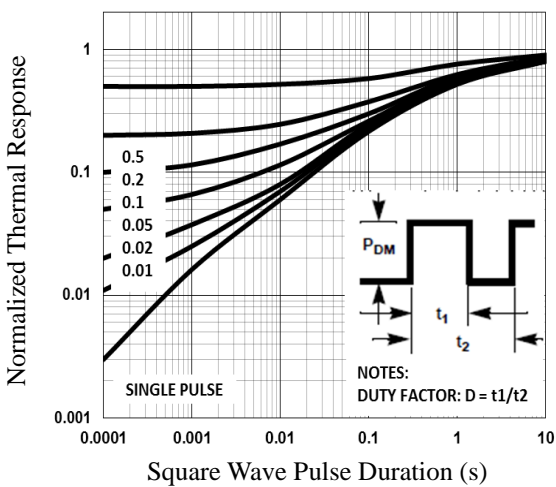

Fig.5 Normalized Transient Impedance

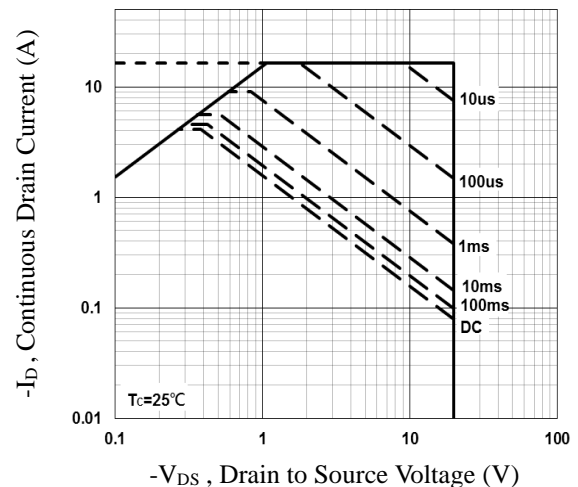

Fig.6 Maximum Safe Operation Area

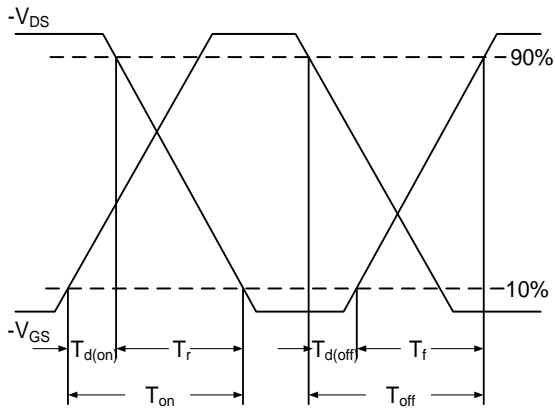

Fig.7 Switching Time Waveform

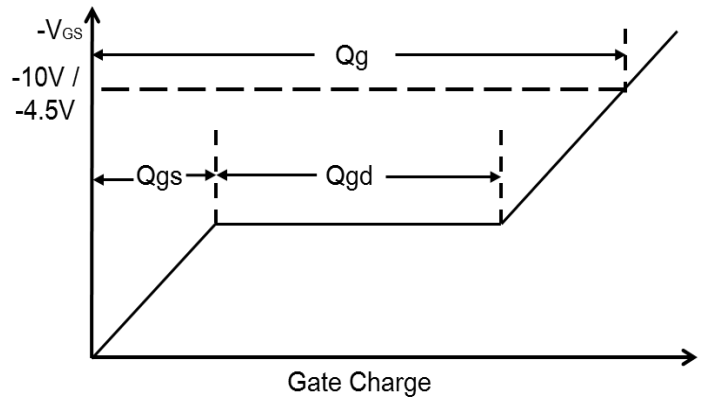
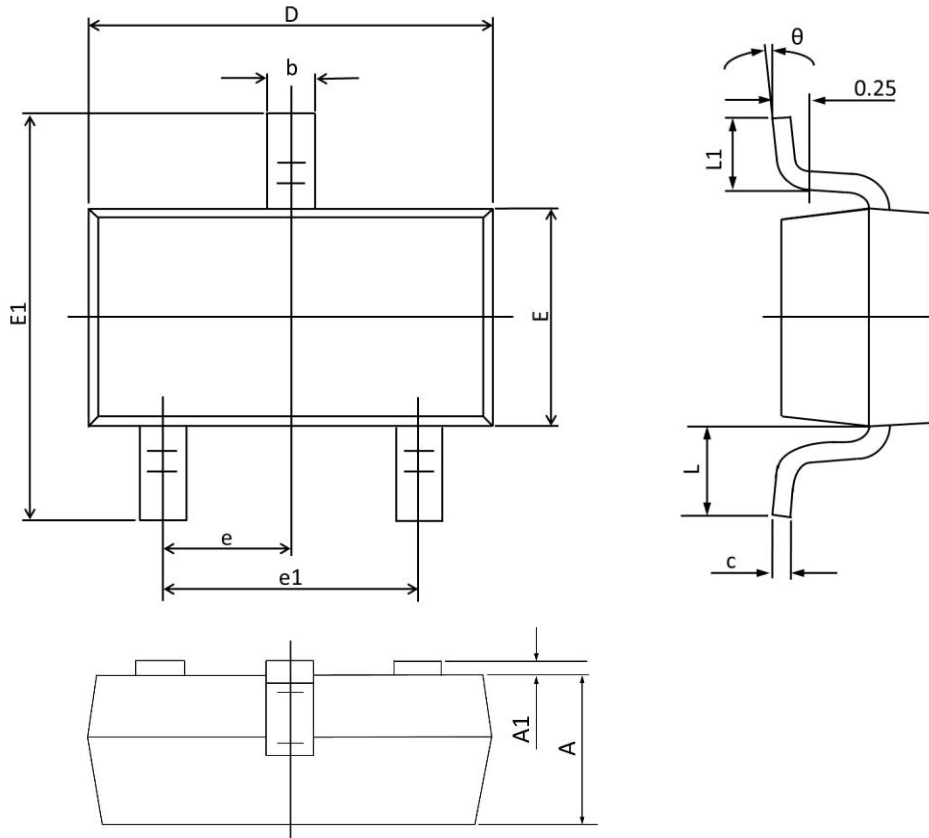

Fig.8 Gate Charge Waveform

SOT23-3S PACKAGE INFORMATION



Symbol	Dimensions In Millimeters		Dimensions In Inches	
	Min	Max	Min	Max
A	0.900	1.110	0.035	0.044
A1	0.001	0.100	0.000	0.004
b	0.300	0.500	0.012	0.020
c	0.080	0.180	0.003	0.008
D	2.800	3.040	0.110	0.120
E	1.200	1.400	0.047	0.055
E1	2.100	2.640	0.080	0.104
e	0.950 TYP.		0.037 TYP.	
e1	1.780	2.040	0.070	0.080
L	0.550 REF.		0.022 REF.	
L1	0.100	0.500	0.004	0.020
θ	1°	10°	1°	10°