

General Description

These N-Channel enhancement mode power field effect transistors are using trench DMOS technology. This advanced technology has been especially tailored to minimize on-state resistance, provide superior switching performance, and withstand high energy pulse in the avalanche and commutation mode. These devices are well suited for high efficiency fast switching applications.

BVDSS	RDSON	ID
100V	41mΩ	3.5A

Features

- 100V,3.5A, $R_{DS(ON)}=41m\Omega@V_{GS} = 10V$
- Improved dv/dt capability
- Fast switching
- Green Device Available

SOT23-3 Pin Configuration

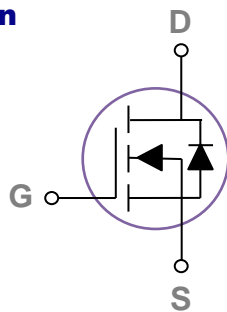
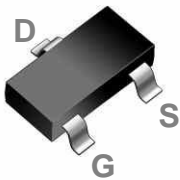

Applications

- Notebook
- Load Switch
- LED applications
- Hand-held Instruments

Absolute Maximum Ratings $T_c=25^\circ\text{C}$ unless otherwise noted

Symbol	Parameter	Rating	Units
V_{DS}	Drain-Source Voltage	100	V
V_{GS}	Gate-Source Voltage	+20 / -12	V
I_D	Drain Current – Continuous ($T_A=25^\circ\text{C}$)	3.5	A
	Drain Current – Continuous ($T_A=70^\circ\text{C}$)	2.7	A
I_{DM}	Drain Current – Pulsed ¹	14	A
P_D	Power Dissipation ($T_A=25^\circ\text{C}$)	1.56	W
	Power Dissipation – Derate above 25°C	12.5	mW/ $^\circ\text{C}$
T_{STG}	Storage Temperature Range	-55 to 150	$^\circ\text{C}$
T_J	Operating Junction Temperature Range	-55 to 150	$^\circ\text{C}$

Thermal Characteristics

Symbol	Parameter	Typ.	Max.	Unit
$R_{\theta JA}$	Thermal Resistance Junction to ambient	---	80	$^\circ\text{C/W}$

Electrical Characteristics ($T_J=25\text{ }^\circ\text{C}$, unless otherwise noted)
Off Characteristics

Symbol	Parameter	Conditions	Min.	Typ.	Max.	Unit
BV_{DSS}	Drain-Source Breakdown Voltage	$V_{GS}=0V, I_D=250\mu A$	100	---	---	V
I_{DSS}	Drain-Source Leakage Current	$V_{DS}=100V, V_{GS}=0V, T_J=25^\circ C$	---	---	1	μA
		$V_{DS}=80V, V_{GS}=0V, T_J=100^\circ C$	---	---	10	μA
I_{GSS}	Gate-Source Leakage Current	$V_{GS}=20V, V_{DS}=0V$	---	---	100	nA

On Characteristics

$R_{DS(ON)}$	Static Drain-Source On-Resistance	$V_{GS}=10V, I_D=3A$	---	34	41	m Ω
		$V_{GS}=4.5V, I_D=2A$	---	46	60	m Ω
$V_{GS(th)}$	Gate Threshold Voltage	$V_{GS}=V_{DS}, I_D=250\mu A$	1	1.5	2.5	V
gfs	Forward Transconductance	$V_{DS}=10V, I_D=1A$	---	3.8	---	S

Dynamic and switching Characteristics

Q_g	Total Gate Charge ^{2,3}	$V_{DS}=30V, V_{GS}=10V, I_D=3A$	---	7.7	11	nC
Q_{gs}	Gate-Source Charge ^{2,3}		---	1.1	1.6	
Q_{gd}	Gate-Drain Charge ^{2,3}		---	3	4.5	
$T_{d(on)}$	Turn-On Delay Time ^{2,3}	$V_{DD}=50V, V_{GS}=10V, R_G=3.3\Omega$ $I_D=1A$	---	7.4	15	ns
T_r	Rise Time ^{2,3}		---	12	24	
$T_{d(off)}$	Turn-Off Delay Time ^{2,3}		---	23	46	
T_f	Fall Time ^{2,3}		---	16	32	
C_{iss}	Input Capacitance	$V_{DS}=50V, V_{GS}=0V, F=1MHz$	---	582	3000	pF
C_{oss}	Output Capacitance		---	188	280	
C_{rss}	Reverse Transfer Capacitance		---	12	240	
R_g	Gate resistance	$V_{GS}=0V, V_{DS}=0V, F=1MHz$	---	0.9	---	Ω

Drain-Source Diode Characteristics and Maximum Ratings

Symbol	Parameter	Conditions	Min.	Typ.	Max.	Unit
I_S	Continuous Source Current	$V_G=V_D=0V$, Force Current	---	---	3.5	A
I_{SM}	Pulsed Source Current		---	---	7	A
V_{SD}	Diode Forward Voltage	$V_{GS}=0V, I_S=1A, T_J=25^\circ C$	---	---	1	V
T_{rr}	Reverse Recovery Time ³	$V_{GS}=0V, I_S=2A, di/dt=100A/\mu s$ $T_J=25^\circ C$	---	28	---	ns
Q_{rr}	Reverse Recovery Charge ³		---	23	---	nC

Note :

1. Repetitive Rating : Pulsed width limited by maximum junction temperature.
2. The data tested by pulsed , pulse width $\leq 300\mu s$, duty cycle $\leq 2\%$.
3. Essentially independent of operating temperature.

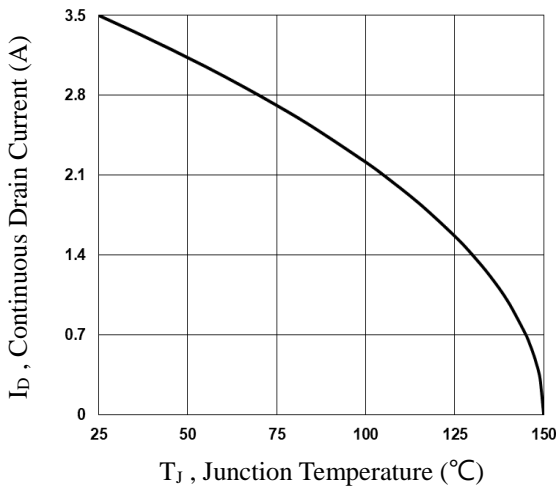

Fig.1 Continuous Drain Current vs. T_J

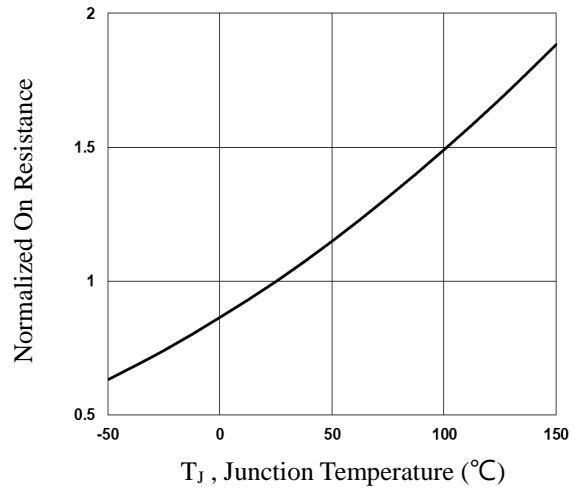

Fig.2 Normalized $R_{DS(on)}$ vs. T_J

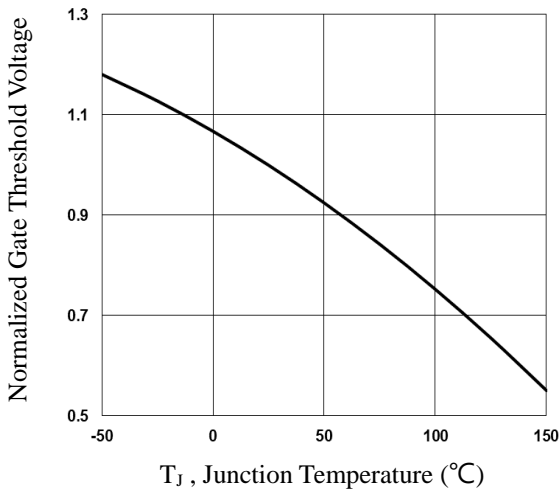

Fig.3 Normalized V_{th} vs. T_J

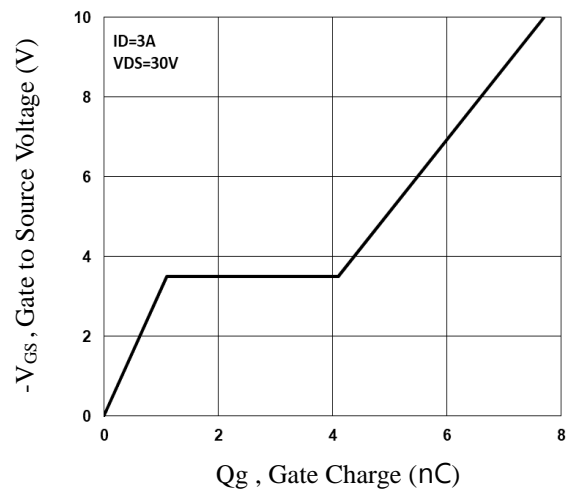

Fig.4 Gate Charge Waveform

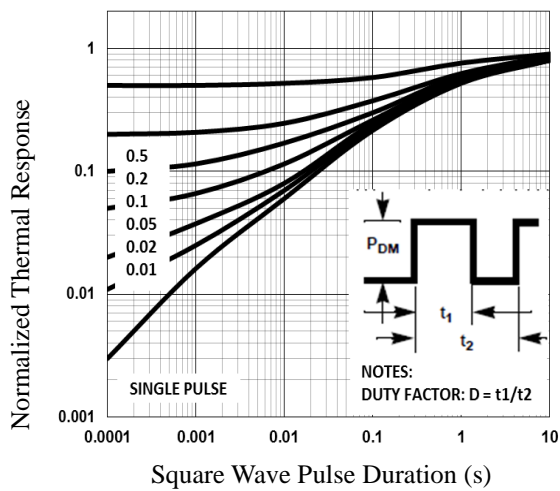

Fig.5 Normalized Transient Impedance

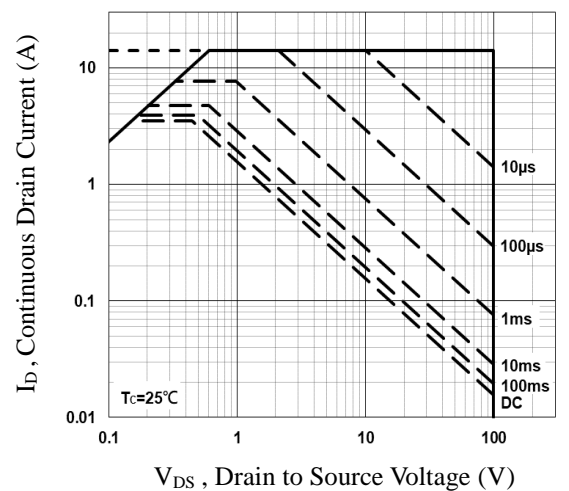

Fig.6 Maximum Safe Operation Area

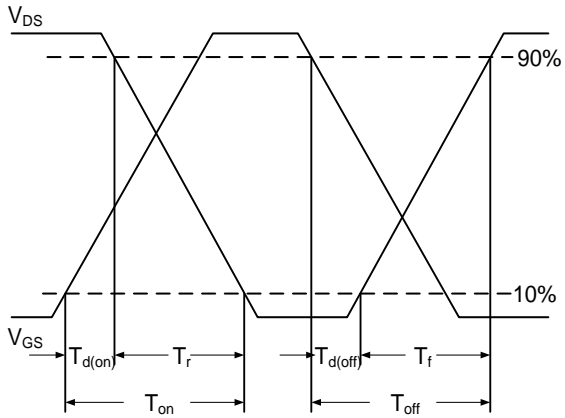

Fig.7 Switching Time Waveform

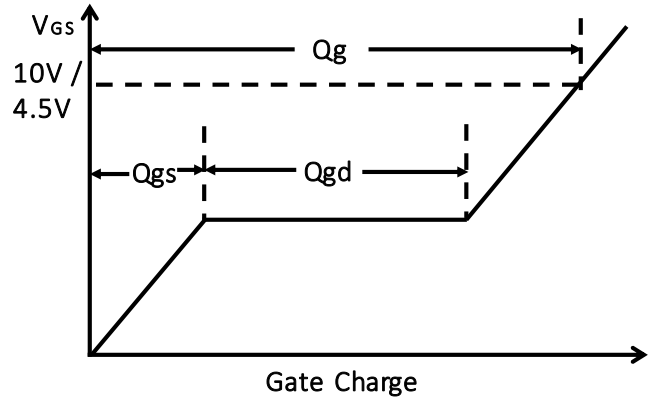
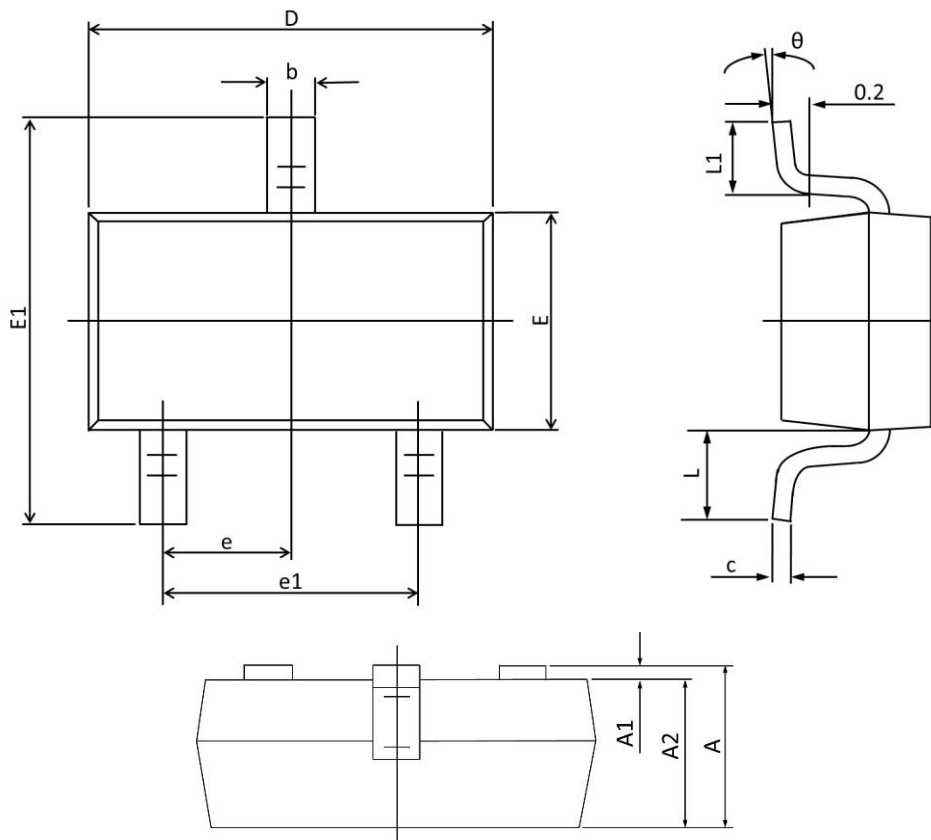

Fig.8 Gate Charge Waveform

SOT23-3 PACKAGE INFORMATION



Symbol	Dimensions In Millimeters		Dimensions In Inches	
	Min	Max	Min	Max
A	1.050	1.450	0.041	0.057
A1	---	0.150	---	0.006
A2	0.900	1.300	0.035	0.051
b	0.300	0.490	0.012	0.019
c	0.100	0.200	0.004	0.008
D	2.820	3.050	0.111	0.120
E	1.500	1.750	0.059	0.069
E1	2.600	3.000	0.102	0.118
e	0.950 TYP.		0.037 TYP.	
e1	1.800	2.000	0.071	0.079
L	0.700 REF.		0.028 REF.	
L1	0.300	0.600	0.012	0.024
θ	0°	8°	0°	8°