

General Description

These P-Channel enhancement mode power field effect transistors are using trench DMOS technology. This advanced technology has been especially tailored to minimize on-state resistance, provide superior switching performance, and withstand high energy pulse in the avalanche and commutation mode. These devices are well suited for high efficiency fast switching applications.

BVDSS	RDSON	ID
-30V	45mΩ	-4.6A

Features

- -30V, -4.6A, $R_{DS(ON)} = 45m\Omega @ V_{GS} = -10V$
- Fast switching
- Green Device Available
- Suit for -2.5V Gate Drive Applications

SOT23-3S Pin Configuration

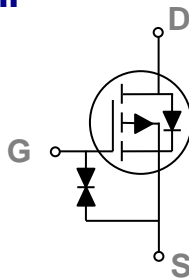
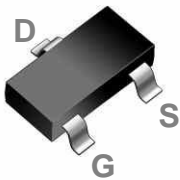

Applications

- Notebook
- Load Switch
- Battery Protection
- Hand-Held Instruments

Absolute Maximum Ratings $T_c=25^\circ\text{C}$ unless otherwise noted

Symbol	Parameter	Rating	Units
V_{DS}	Drain-Source Voltage	-30	V
V_{GS}	Gate-Source Voltage	± 12	V
I_D	Drain Current – Continuous ($T_A=25^\circ\text{C}$)	-4.6	A
	Drain Current – Continuous ($T_A=70^\circ\text{C}$)	-3.7	A
I_{DM}	Drain Current – Pulsed ¹	-18.4	A
P_D	Power Dissipation ($T_A=25^\circ\text{C}$)	1.56	W
	Power Dissipation – Derate above 25°C	0.0125	W/ $^\circ\text{C}$
T_{STG}	Storage Temperature Range	-55 to 150	$^\circ\text{C}$
T_J	Operating Junction Temperature Range	-55 to 150	$^\circ\text{C}$

Thermal Characteristics

Symbol	Parameter	Typ.	Max.	Unit
$R_{\theta JA}$	Thermal Resistance Junction to ambient	---	80	$^\circ\text{C/W}$

Electrical Characteristics (T_J=25 °C, unless otherwise noted)
Off Characteristics

Symbol	Parameter	Conditions	Min.	Typ.	Max.	Unit
BV _{DSS}	Drain-Source Breakdown Voltage	V _{GS} =0V, I _D =-250uA	-30	---	---	V
ΔBV _{DSS} /ΔT _J	BV _{DSS} Temperature Coefficient	Reference to 25°C, I _D =-1mA	---	-0.03	---	V/°C
I _{DSS}	Drain-Source Leakage Current	V _{DS} =-30V, V _{GS} =0V, T _J =25°C	---	---	-1	uA
		V _{DS} =-24V, V _{GS} =0V, T _J =125°C	---	---	-10	uA
I _{GSS}	Gate-Source Leakage Current	V _{GS} =±12V, V _{DS} =0V	---	---	±20	uA

On Characteristics

R _{DS(ON)}	Static Drain-Source On-Resistance	V _{GS} =-10V, I _D =-4A	---	37	45	mΩ
		V _{GS} =-4.5V, I _D =-3A	---	43	56	mΩ
		V _{GS} =-2.5V, I _D =-2A	---	55	74	mΩ
V _{GS(th)}	Gate Threshold Voltage	V _{GS} =V _{DS} , I _D =-250uA	-0.5	-0.7	-1.2	V
ΔV _{GS(th)}	V _{GS(th)} Temperature Coefficient		---	3	---	mV/°C

Dynamic and switching Characteristics

Q _g	Total Gate Charge ^{2, 3}	V _{DS} =-15V, V _{GS} =-4.5V, I _D =-4A	---	12	18	nC
Q _{gs}	Gate-Source Charge ^{2, 3}		---	2.9	4.4	
Q _{gd}	Gate-Drain Charge ^{2, 3}		---	2.1	3.2	
T _{d(on)}	Turn-On Delay Time ^{2, 3}	V _{DD} =-15V, V _{GS} =-10V, R _G =6Ω I _D =-1A	---	7.3	11	ns
T _r	Rise Time ^{2, 3}		---	26	39	
T _{d(off)}	Turn-Off Delay Time ^{2, 3}		---	60	90	
T _f	Fall Time ^{2, 3}		---	16	24	
C _{iss}	Input Capacitance	V _{DS} =-15V, V _{GS} =0V, F=1MHz	---	1585	2378	pF
C _{oss}	Output Capacitance		---	97	146	
C _{rss}	Reverse Transfer Capacitance		---	68	102	

Drain-Source Diode Characteristics and Maximum Ratings

Symbol	Parameter	Conditions	Min.	Typ.	Max.	Unit
I _S	Continuous Source Current	V _G =V _D =0V, Force Current	---	---	-4.6	A
I _{SM}	Pulsed Source Current		---	---	-9.2	A
V _{SD}	Diode Forward Voltage	V _{GS} =0V, I _S =-1A, T _J =25°C	---	---	-1	V
T _{rr}	Reverse Recovery Time	V _R =-30V, I _S =-2A,	---	45	---	ns
Q _{rr}	Reverse Recovery Charge	di/dt=100A/μs, T _J =25°C	---	50	---	nC

Note :

1. Repetitive Rating : Pulsed width limited by maximum junction temperature.
2. The data tested by pulsed, pulse width ≤ 300us, duty cycle ≤ 2%.
3. Essentially independent of operating temperature.

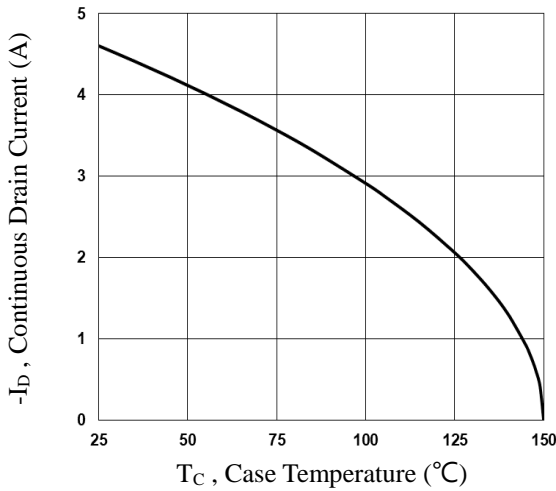

Fig.1 Continuous Drain Current vs. T_c

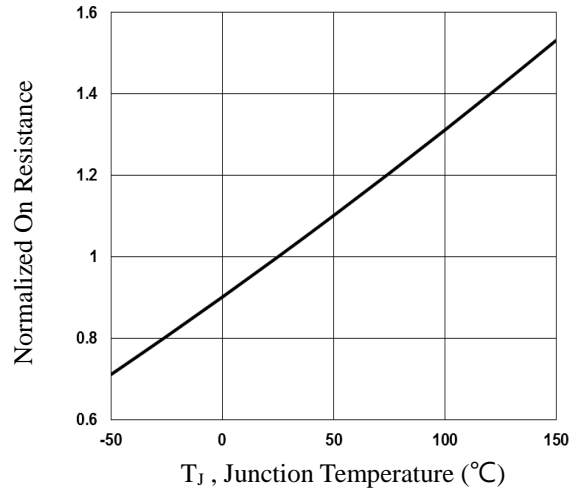

Fig.2 Normalized $R_{DS(on)}$ vs. T_j

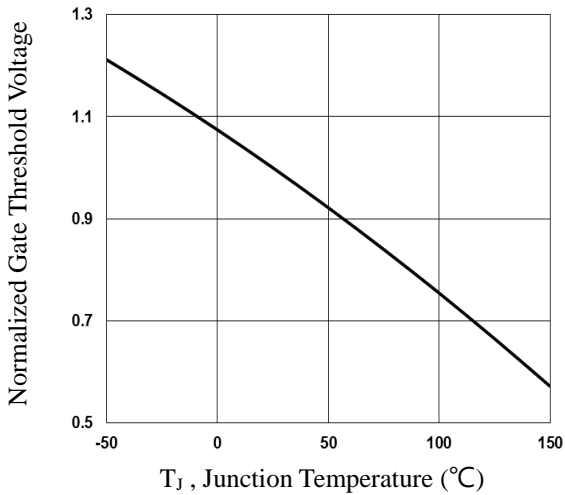

Fig.3 Normalized V_{th} vs. T_j

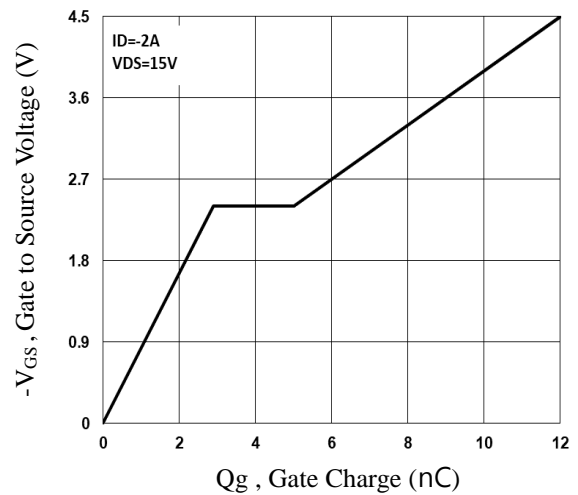

Fig.4 Gate Charge Waveform

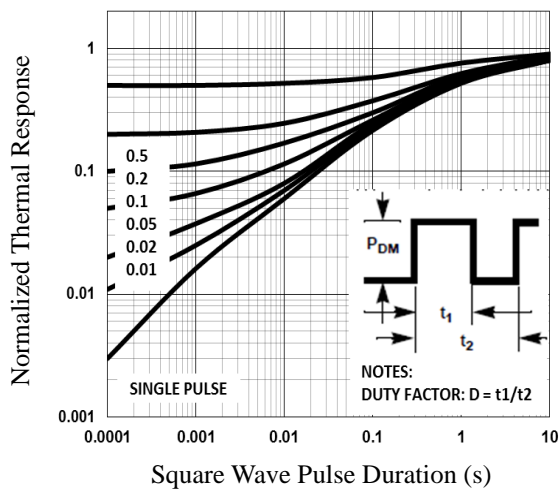

Fig.5 Normalized Transient Impedance

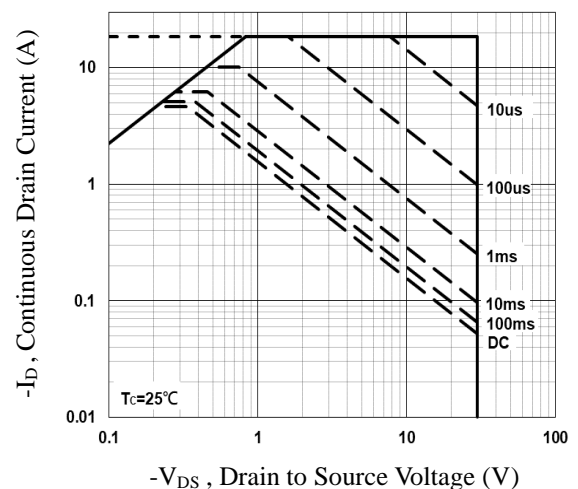

Fig.6 Maximum Safe Operation Area

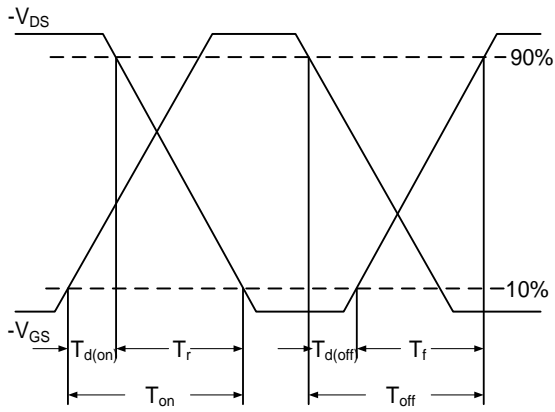

Fig.7 Switching Time Waveform

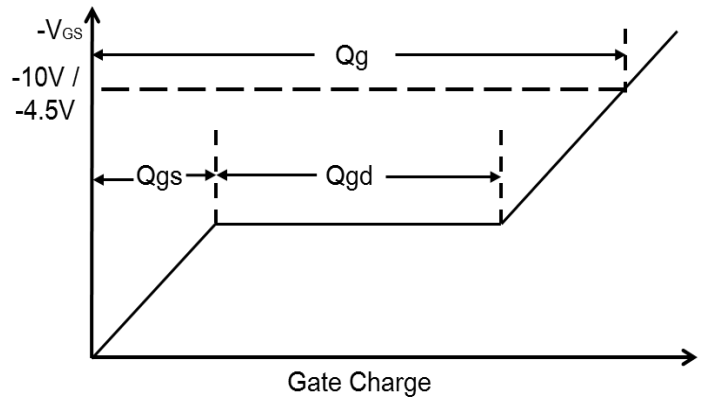
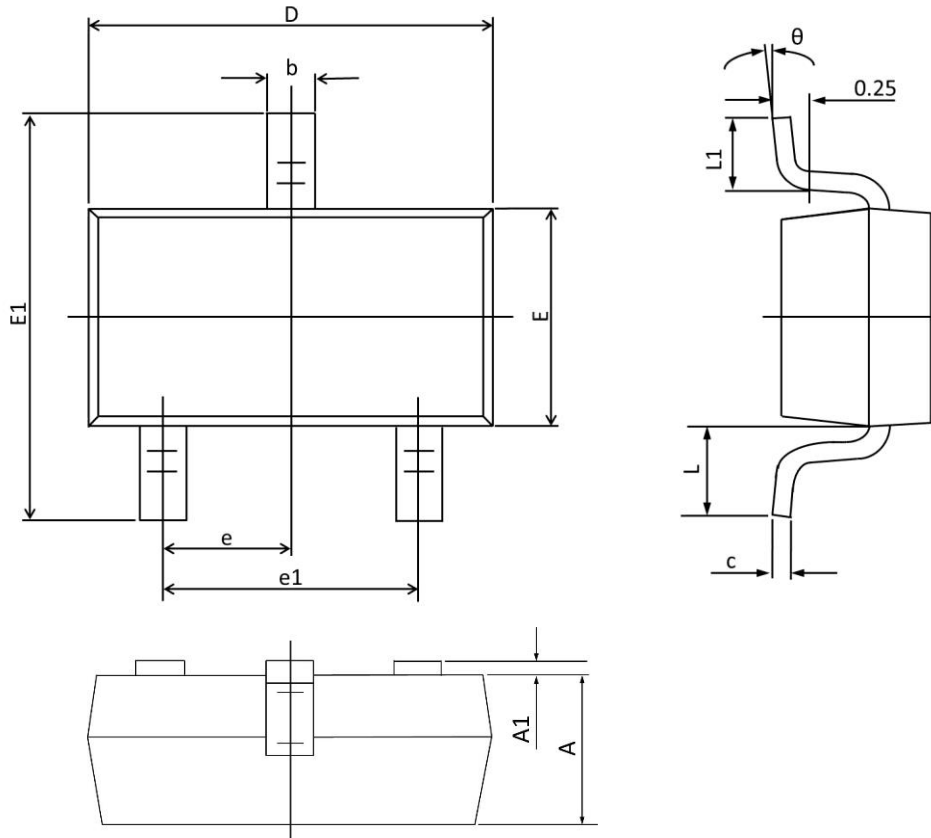

Fig.8 Gate Charge Waveform

SOT23-3S PACKAGE INFORMATION



Symbol	Dimensions In Millimeters		Dimensions In Inches	
	Min	Max	Min	Max
A	0.900	1.150	0.035	0.045
A1	0.001	0.100	0.000	0.004
b	0.300	0.500	0.012	0.020
c	0.080	0.180	0.003	0.008
D	2.700	3.100	0.106	0.122
E	1.100	1.500	0.043	0.059
E1	2.100	2.640	0.080	0.104
e	0.950 TYP.		0.037 TYP.	
e1	1.780	2.040	0.070	0.080
L	0.550 REF.		0.022 REF.	
L1	0.100	0.500	0.004	0.020
θ	1°	10°	1°	10°