

General Description

These P-Channel enhancement mode power field effect transistors are using trench DMOS technology. This advanced technology has been especially tailored to minimize on-state resistance, provide superior switching performance, and withstand high energy pulse in the avalanche and commutation mode. These devices are well suited for high efficiency fast switching applications.

BVDSS	R _{DS(ON)}	I _D
-40V	14mΩ	-38A

Features

- -40V, -38A, R_{DS(ON)} = 14mΩ @ V_{GS} = -10V
- Fast switching
- Green Device Available
- Suit for -4.5V Gate Drive Applications

PPAK3x3 Pin Configuration

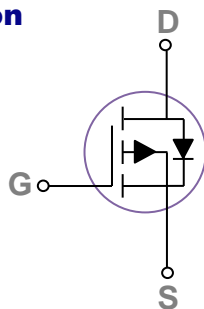
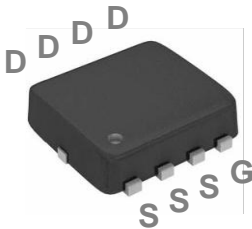

Applications

- MB / VGA / Vcore
- POL Applications
- Load Switch
- LED Application

Absolute Maximum Ratings T_C=25°C unless otherwise noted

Symbol	Parameter	Rating	Units
V _{DS}	Drain-Source Voltage	-40	V
V _{GS}	Gate-Source Voltage	±20	V
I _D	Drain Current – Continuous (T _C =25°C)	-38	A
	Drain Current – Continuous (T _C =100°C)	-24	A
I _{DM}	Drain Current – Pulsed ¹	-152	A
EAS	Single Pulse Avalanche Energy ²	130	mJ
IAS	Single Pulse Avalanche Current ²	51	A
P _D	Power Dissipation (T _C =25°C)	52	W
	Power Dissipation – Derate above 25°C	0.42	W/°C
T _{STG}	Storage Temperature Range	-55 to 150	°C
T _J	Operating Junction Temperature Range	-55 to 150	°C

Thermal Characteristics

Symbol	Parameter	Typ.	Max.	Unit
R _{θJC}	Thermal Resistance Junction to Case	---	2.4	°C/W
R _{θJA}	Thermal Resistance Junction to Ambient	---	62	°C/W

Electrical Characteristics (T_J=25 °C, unless otherwise noted)
Off Characteristics

Symbol	Parameter	Conditions	Min.	Typ.	Max.	Unit
BV _{DSS}	Drain-Source Breakdown Voltage	V _{GS} =0V, I _D =-250uA	-40	---	---	V
I _{DSS}	Drain-Source Leakage Current	V _{DS} =-40V, V _{GS} =0V, T _J =25°C	---	---	-1	uA
		V _{DS} =-32V, V _{GS} =0V, T _J =125°C	---	---	-10	uA
I _{GSS}	Gate-Source Leakage Current	V _{GS} =±20V, V _{DS} =0V	---	---	±100	nA

On Characteristics

R _{DS(ON)}	Static Drain-Source On-Resistance	V _{GS} =-10V, I _D =-15A	---	11.3	14	mΩ
		V _{GS} =-4.5V, I _D =-8A	---	15.6	21	mΩ
V _{GS(th)}	Gate Threshold Voltage	V _{GS} =V _{DS} , I _D =-250uA	-1.0	-1.6	-2.5	V
g _{fs}	Forward Transconductance	V _{DS} =-10V, I _D =-4A	---	11	---	S

Dynamic and switching Characteristics

Q _g	Total Gate Charge ^{3, 4}	V _{DS} =-32V, V _{GS} =-4.5V, I _D =-10A	---	22.2	40	nC
Q _{gs}	Gate-Source Charge ^{3, 4}		---	8.2	16	
Q _{gd}	Gate-Drain Charge ^{3, 4}		---	8.8	16	
T _{d(on)}	Turn-On Delay Time ^{3, 4}	V _{DD} =-20V, V _{GS} =-10V, R _G =6Ω I _D =-1A	---	23	40	ns
T _r	Rise Time ^{3, 4}		---	10	20	
T _{d(off)}	Turn-Off Delay Time ^{3, 4}		---	135	250	
T _f	Fall Time ^{3, 4}		---	46	90	
C _{iss}	Input Capacitance	V _{DS} =-25V, V _{GS} =0V, F=1MHz	---	2757	4000	pF
C _{oss}	Output Capacitance		---	240	360	
C _{rss}	Reverse Transfer Capacitance		---	137	200	

Drain-Source Diode Characteristics and Maximum Ratings

Symbol	Parameter	Conditions	Min.	Typ.	Max.	Unit
I _S	Continuous Source Current	V _G =V _D =0V, Force Current	---	---	-38	A
I _{SM}	Pulsed Source Current		---	---	-76	A
V _{SD}	Diode Forward Voltage	V _{GS} =0V, I _S =-1A, T _J =25°C	---	---	-1	V

Note :

1. Repetitive Rating : Pulsed width limited by maximum junction temperature.
2. V_{DD}=25V, V_{GS}=10V, L=0.1mH, I_{AS}=51A., R_G=25Ω, Starting T_J=25°C.
3. The data tested by pulsed, pulse width ≤ 300us, duty cycle ≤ 2%.
4. Essentially independent of operating temperature.

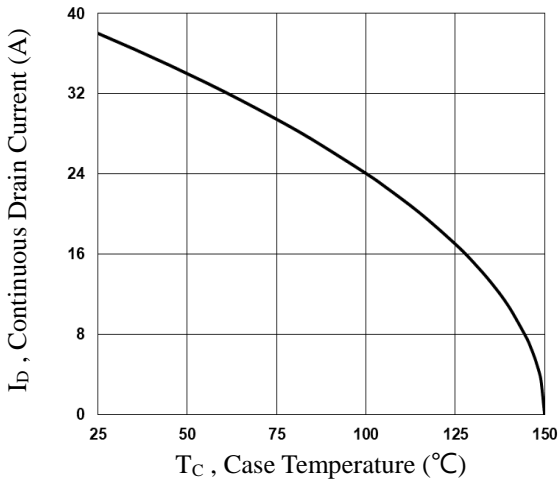

Fig.1 Continuous Drain Current vs. T_c

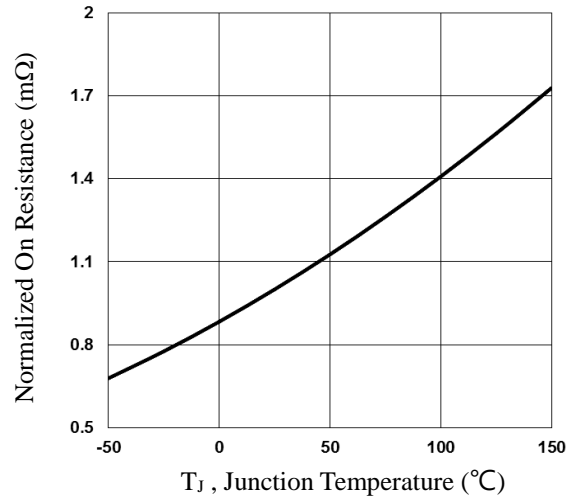

Fig.2 Normalized R_{DS(on)} vs. T_j

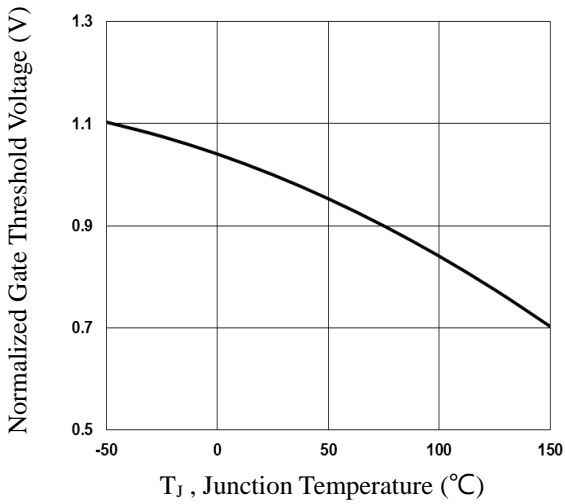

Fig.3 Normalized V_{th} vs. T_j

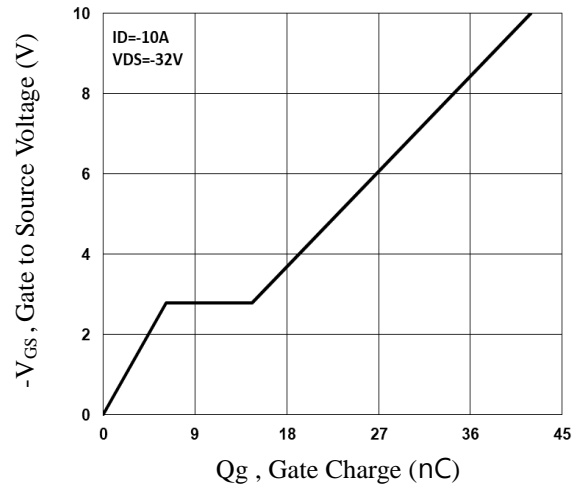

Fig.4 Gate Charge Waveform

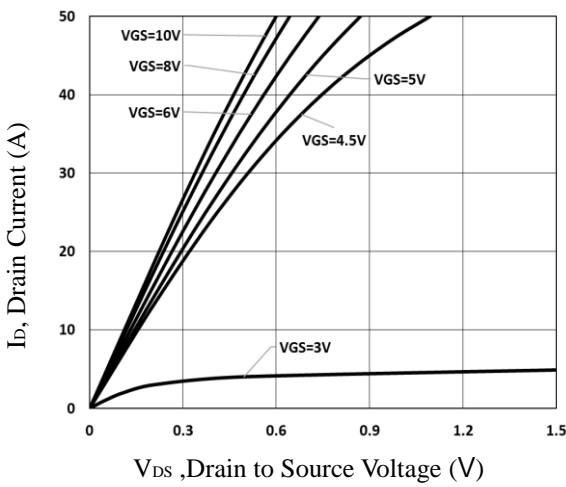

Fig.5 Typical Output Characteristics

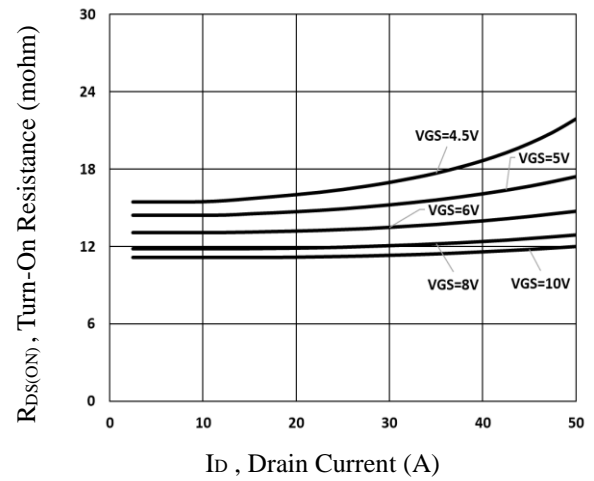

Fig.6 Turn-On Resistance vs. I_D

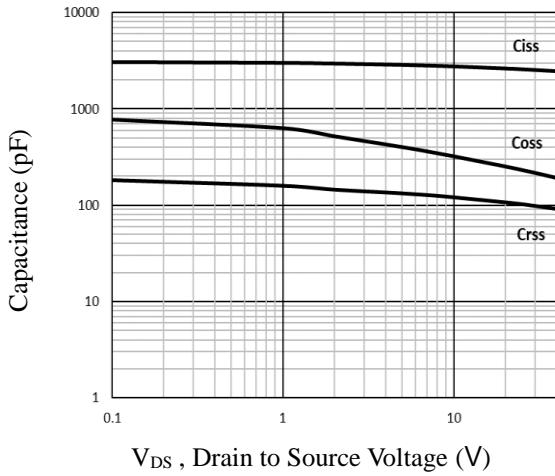

Fig.7 Capacitance Characteristics

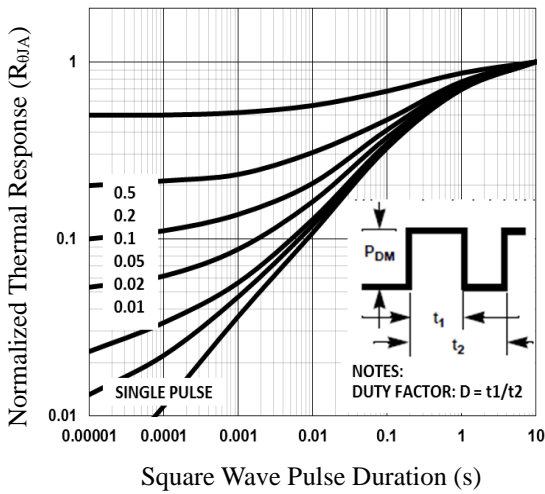

Fig.8 Normalized Transient Impedance

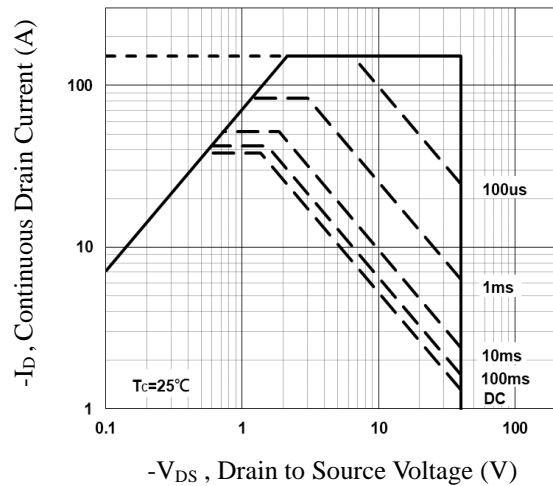

Fig.9 Maximum Safe Operation Area

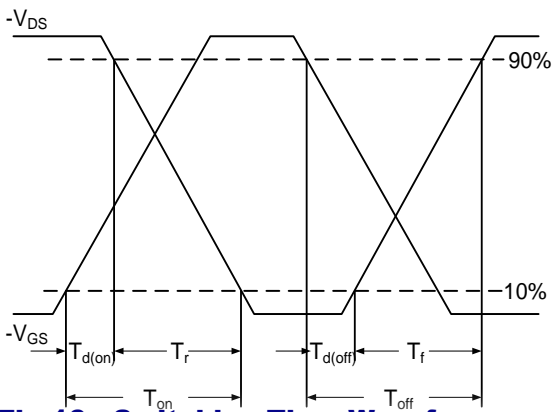

Fig.10 Switching Time Waveform

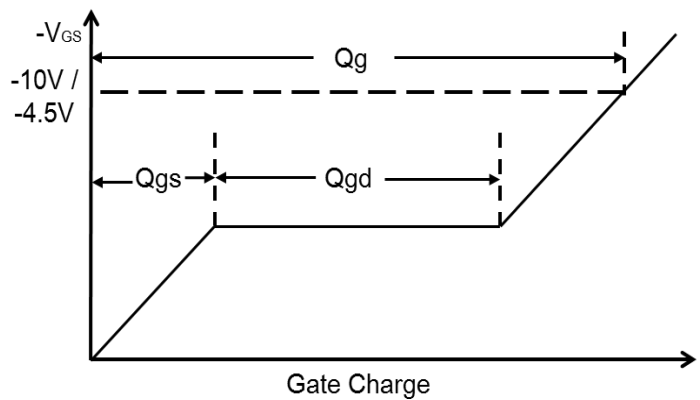
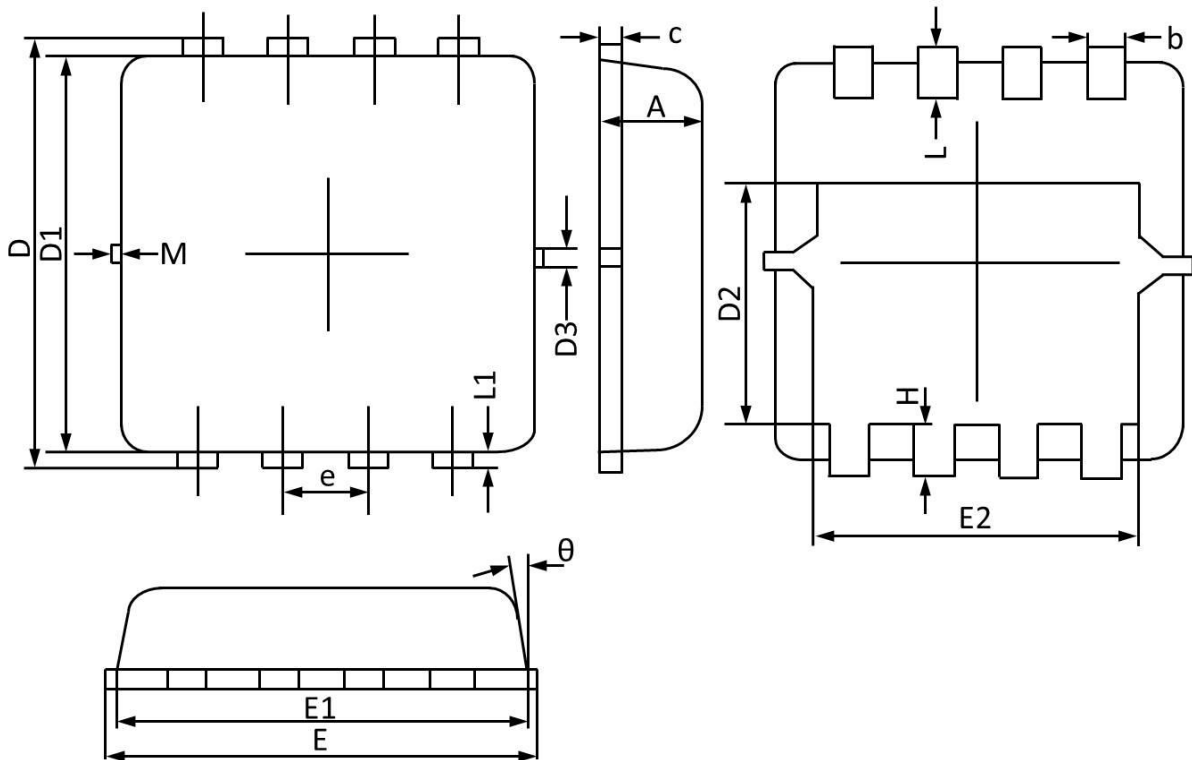

Fig.11 Gate Charge Waveform

PPAK3X3 PACKAGE INFORMATION



Symbol	Dimensions In Millimeters		Dimensions In Inches	
	Min	Max	Min	Max
A	0.700	0.800	0.028	0.031
b	0.250	0.350	0.010	0.013
c	0.100	0.250	0.004	0.009
D	3.250	3.450	0.128	0.135
D1	3.000	3.200	0.119	0.125
D2	1.780	1.980	0.070	0.077
D3	0.130 REF		0.005 REF	
E	3.200	3.400	0.126	0.133
E1	3.000	3.200	0.119	0.125
E2	2.390	2.590	0.094	0.102
e	0.650 BSC		0.026 BSC	
H	0.300	0.500	0.011	0.019
L	0.300	0.500	0.011	0.019
L1	0.130 REF		0.005 REF	
θ	0°	12°	0°	12°
M	0.150 REF		0.006 REF	