

General Description

These N-Channel enhancement mode power field effect transistors are using trench DMOS technology. This advanced technology has been especially tailored to minimize on-state resistance, provide superior switching performance, and withstand high energy pulse in the avalanche and commutation mode. These devices are well suited for high efficiency fast switching applications.

BVDSS	RDSON	ID
30V	7.8mΩ	48A

PPAK3x3 Pin Configuration

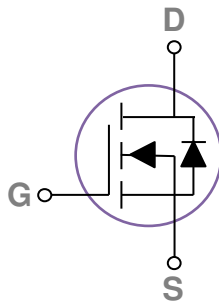
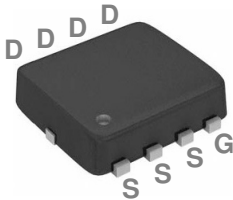

Features

- 30V,48A, $R_{DS(ON)} = 7.8m\Omega @ V_{GS} = 10V$
- Improved dv/dt capability
- Fast switching
- 100% EAS Guaranteed
- Green Device Available

Applications

- MB / VGA / Vcore
- POL Applications
- SMPS 2nd SR

Absolute Maximum Ratings $T_C=25^\circ C$ unless otherwise noted

Symbol	Parameter	Rating	Units
V_{DS}	Drain-Source Voltage	30	V
V_{GS}	Gate-Source Voltage	± 20	V
I_D	Drain Current – Continuous ($T_C=25^\circ C$)	48	A
	Drain Current – Continuous ($T_C=100^\circ C$)	30	A
I_{DM}	Drain Current – Pulsed ¹	192	A
EAS	Single Pulse Avalanche Energy ²	45	mJ
IAS	Single Pulse Avalanche Current ²	30	A
P_D	Power Dissipation ($T_C=25^\circ C$)	35	W
	Power Dissipation – Derate above $25^\circ C$	0.28	W/ $^\circ C$
T_{STG}	Storage Temperature Range	-55 to 150	$^\circ C$
T_J	Operating Junction Temperature Range	-55 to 150	$^\circ C$

Thermal Characteristics

Symbol	Parameter	Typ.	Max.	Unit
$R_{\theta JA}$	Thermal Resistance Junction to ambient	---	62	$^\circ C/W$
$R_{\theta JC}$	Thermal Resistance Junction to Case	---	3.6	$^\circ C/W$

Electrical Characteristics (T_J=25 °C, unless otherwise noted)
Static State Characteristics

Symbol	Parameter	Conditions	Min.	Typ.	Max.	Unit
BV _{DSS}	Drain-Source Breakdown Voltage	V _{GS} =0V, I _D =250uA	30	---	---	V
ΔBV _{DSS} /ΔT _J	BV _{DSS} Temperature Coefficient	Reference to 25°C, I _D =1mA	---	0.04	---	V/°C
I _{DSS}	Drain-Source Leakage Current	V _{DS} =30V, V _{GS} =0V, T _J =25°C	---	---	1	uA
		V _{DS} =24V, V _{GS} =0V, T _J =125°C	---	---	10	uA
I _{GSS}	Gate-Source Leakage Current	V _{GS} =±20V, V _{DS} =0V	---	---	±100	nA
R _{DS(ON)}	Static Drain-Source On-Resistance ³	V _{GS} =10V, I _D =16A	---	6.5	7.8	mΩ
		V _{GS} =4.5V, I _D =8A	---	9.2	12	mΩ
V _{GS(th)}	Gate Threshold Voltage	V _{GS} =V _{DS} , I _D =250uA	1.2	1.6	2.5	V
ΔV _{GS(th)}	V _{GS(th)} Temperature Coefficient		---	-4	---	mV/°C
gfs	Forward Transconductance	V _{DS} =10V, I _D =8A	---	9.5	---	S

Dynamic Characteristics

Q _g	Total Gate Charge ^{3, 4}	V _{DS} =15V, V _{GS} =4.5V, I _D =20A	---	7.5	12	nC
Q _{gs}	Gate-Source Charge ^{3, 4}		---	1.3	2.6	
Q _{gd}	Gate-Drain Charge ^{3, 4}		---	4.5	8	
T _{d(on)}	Turn-On Delay Time ^{3, 4}	V _{DD} =15V, V _{GS} =10V, R _G =3.3Ω I _D =15A	---	4.8	9	ns
T _r	Rise Time ^{3, 4}		---	12.5	24	
T _{d(off)}	Turn-Off Delay Time ^{3, 4}		---	27.6	52	
T _f	Fall Time ^{3, 4}		---	8.2	16	
C _{iss}	Input Capacitance	V _{DS} =25V, V _{GS} =0V, F=1MHz	---	850	1700	pF
C _{oss}	Output Capacitance		---	133	260	
C _{rss}	Reverse Transfer Capacitance		---	78	160	
R _g	Gate resistance	V _{GS} =0V, V _{DS} =0V, F=1MHz	---	2.7	5.4	Ω

Guaranteed Avalanche Energy

Symbol	Parameter	Conditions	Min.	Typ.	Max.	Unit
EAS	Single Pulse Avalanche Energy	V _{DD} =25V, L=0.1mH, I _{AS} =15A	12	---	---	mJ

Drain-Source Diode Characteristics

Symbol	Parameter	Conditions	Min.	Typ.	Max.	Unit
I _S	Continuous Source Current	V _G =V _D =0V, Force Current	---	---	48	A
I _{SM}	Pulsed Source Current ³		---	---	192	A
V _{SD}	Diode Forward Voltage ³	V _{GS} =0V, I _S =1A, T _J =25°C	---	---	1	V
t _{rr}	Reverse Recovery Time	V _{GS} =0V, I _S =1A, di/dt=100A/μs	---	8.1	---	ns
Q _{rr}	Reverse Recovery Charge	T _J =25°C	---	1.6	---	nC

Note :

1. Repetitive Rating : Pulsed width limited by maximum junction temperature.
2. V_{DD}=25V, V_{GS}=10V, L=0.1mH, I_{AS}=30A., R_G=25Ω, Starting T_J=25°C.
3. The data tested by pulsed, pulse width ≤ 300us, duty cycle ≤ 2%.
4. Essentially independent of operating temperature.

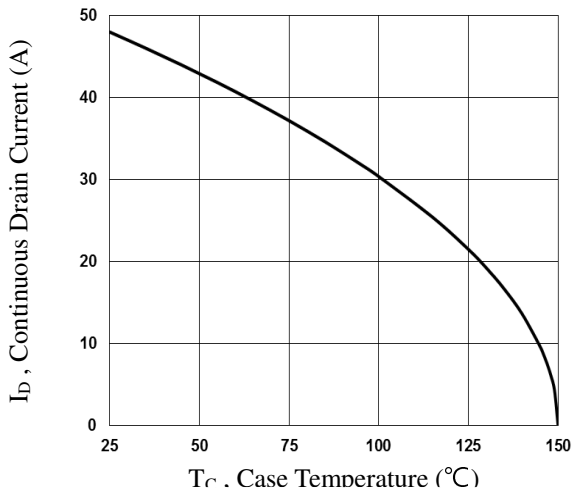

Fig.1 Continuous Drain Current vs. T_c

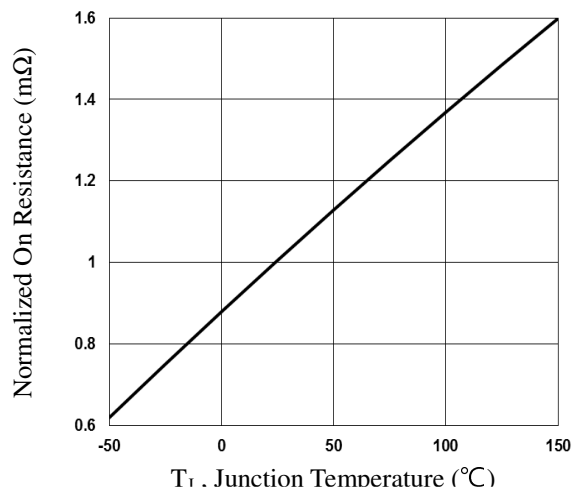

Fig.2 Normalized R_{DS(on)} vs. T_j

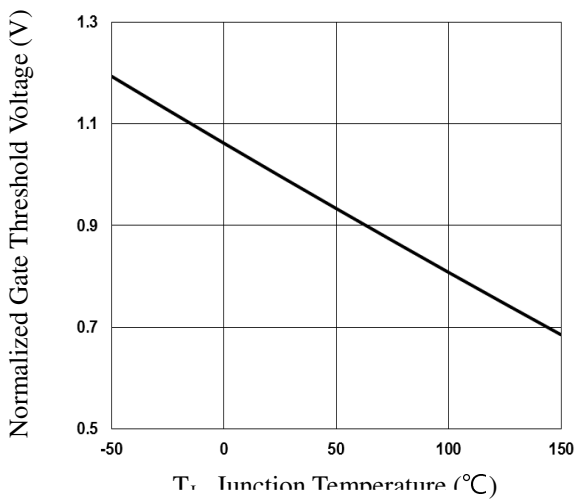

Fig.3 Normalized V_{th} vs. T_j

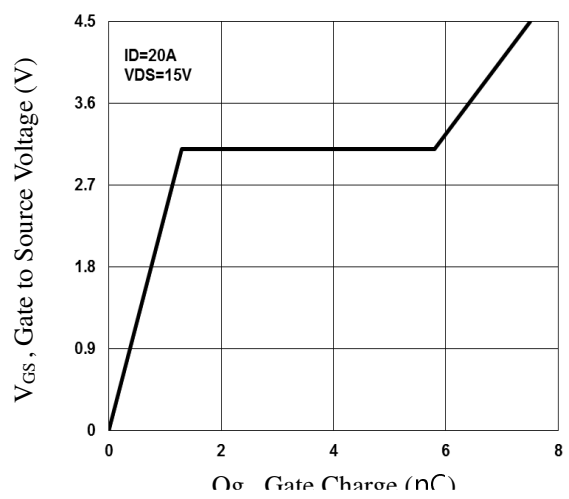

Fig.4 Gate Charge Waveform

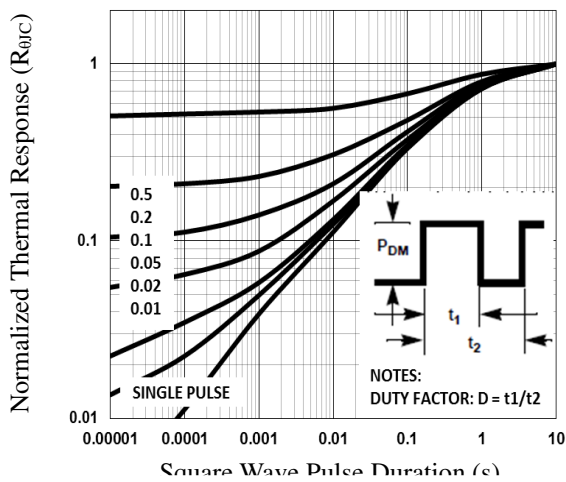

Fig.5 Normalized Transient Impedance

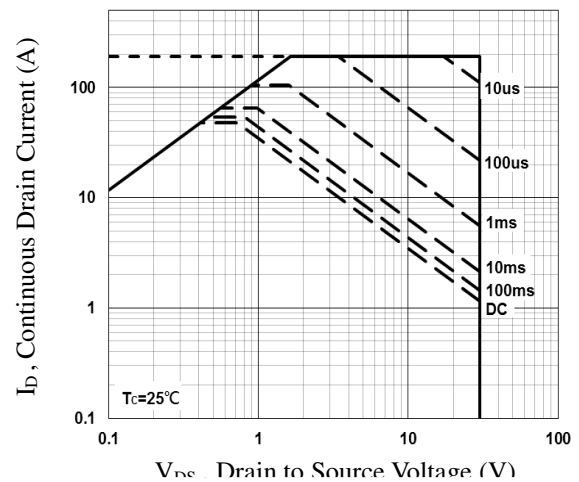

Fig.6 Maximum Safe Operation Area

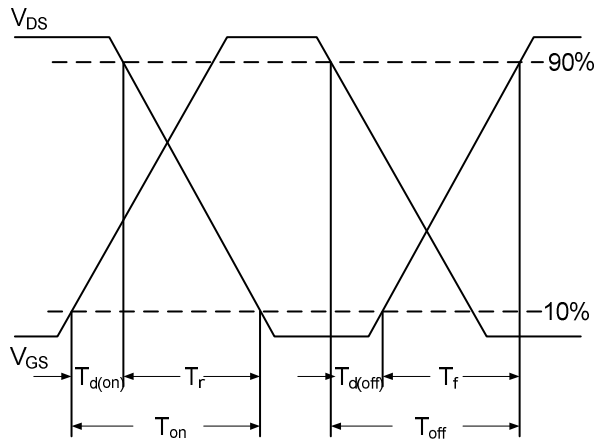

Fig.7 Switching Time Waveform

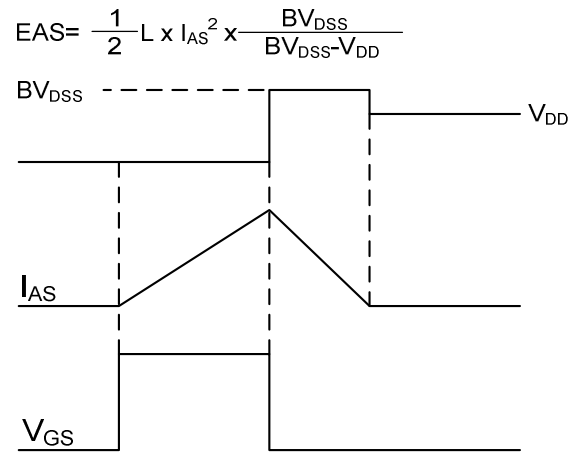
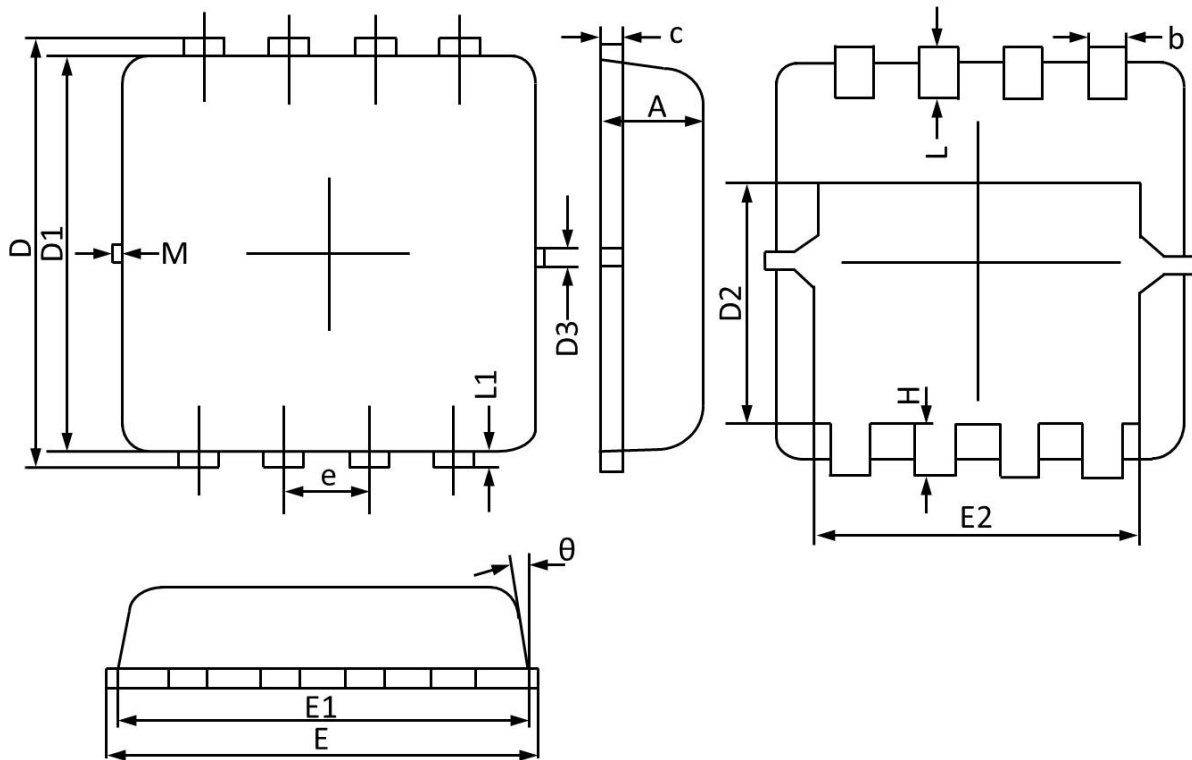

Fig.8 EAS Waveform

PPAK3x3 PACKAGE INFORMATION



Symbol	Dimensions In Millimeters		Dimensions In Inches	
	Min	Max	Min	Max
A	0.700	0.800	0.028	0.031
b	0.250	0.350	0.010	0.013
c	0.100	0.250	0.004	0.009
D	3.250	3.450	0.128	0.135
D1	3.000	3.200	0.119	0.125
D2	1.780	1.980	0.070	0.077
D3	0.130 REF		0.005 REF	
E	3.200	3.400	0.126	0.133
E1	3.000	3.200	0.119	0.125
E2	2.390	2.590	0.094	0.102
e	0.650 BSC		0.026 BSC	
H	0.300	0.500	0.011	0.019
L	0.300	0.500	0.011	0.019
L1	0.130 REF		0.005 REF	
θ	0°	12°	0°	12°
M	0.150 REF		0.006 REF	