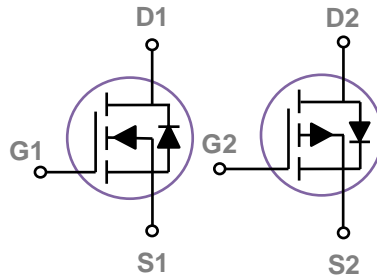
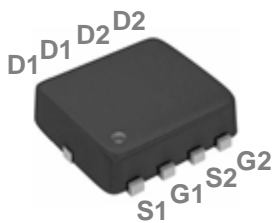


### General Description

These N+P dual Channel enhancement mode power field effect transistors are using trench DMOS technology. This advanced technology has been especially tailored to minimize on-state resistance, provide superior switching performance, and withstand high energy pulse in the avalanche and commutation mode. These devices are well suited for high efficiency fast switching applications.

### PPAK3X3 Dual Pin Configuration



BVDSS	RDSON	ID
30V	11.5mΩ	30A
-30V	23mΩ	-25A

### Features

- Fast switching
- Green Device Available
- 100% EAS Guaranteed

### Applications

- DC Fan
- Motor Drive Applications
- Networking
- Half / Full Bridge Topology

### Absolute Maximum Ratings $T_c=25^\circ\text{C}$ unless otherwise noted

Symbol	Parameter	Rating		Units
$V_{DS}$	Drain-Source Voltage	30	-30	V
$V_{GS}$	Gate-Source Voltage	$\pm 20$	$\pm 20$	V
$I_D$	Drain Current – Continuous ( $T_c=25^\circ\text{C}$ )	30	-25	A
	Drain Current – Continuous ( $T_c=100^\circ\text{C}$ )	19	-16	A
$I_{DM}$	Drain Current – Pulsed <sup>1</sup>	120	-100	A
EAS	Single Pulse Avalanche Energy <sup>2,6</sup>	20	45	mJ
IAS	Single Pulse Avalanche Current <sup>2</sup>	20	-30	A
$P_D$	Power Dissipation ( $T_c=25^\circ\text{C}$ )	22		W
	Power Dissipation – Derate above $25^\circ\text{C}$	0.18		W/ $^\circ\text{C}$
$T_{STG}$	Storage Temperature Range	-55 to 150		$^\circ\text{C}$
$T_J$	Operating Junction Temperature Range	-55 to 150		$^\circ\text{C}$

### Thermal Characteristics

Symbol	Parameter	Typ.	Max.	Unit
$R_{\theta JA}$	Thermal Resistance Junction to ambient	---	62	$^\circ\text{C}/\text{W}$
$R_{\theta JC}$	Thermal Resistance Junction to Case	---	5.6	$^\circ\text{C}/\text{W}$

**N-CH Electrical Characteristics (T<sub>J</sub>=25 °C, unless otherwise)**
**Off Characteristics**

Symbol	Parameter	Conditions	Min.	Typ.	Max.	Unit
BV <sub>DSS</sub>	Drain-Source Breakdown Voltage	V <sub>GS</sub> =0V , I <sub>D</sub> =250uA	30	---	---	V
I <sub>DSS</sub>	Drain-Source Leakage Current	V <sub>DS</sub> =30V , V <sub>GS</sub> =0V , T <sub>J</sub> =25°C	---	---	1	uA
		V <sub>DS</sub> =24V , V <sub>GS</sub> =0V , T <sub>J</sub> =125°C	---	---	10	uA
I <sub>GSS</sub>	Gate-Source Leakage Current	V <sub>GS</sub> =±20V , V <sub>DS</sub> =0V	---	---	±100	nA

**On Characteristics**

R <sub>DS(ON)</sub>	Static Drain-Source On-Resistance	V <sub>GS</sub> =10V , I <sub>D</sub> =8A	---	9.5	11.5	mΩ
		V <sub>GS</sub> =4.5V , I <sub>D</sub> =5A	---	12	16	mΩ
V <sub>GS(th)</sub>	Gate Threshold Voltage	V <sub>GS</sub> =V <sub>DS</sub> , I <sub>D</sub> =250uA	1.2	1.5	2.5	V
g <sub>fs</sub>	Forward Transconductance	V <sub>DS</sub> =10V , I <sub>D</sub> =5A	---	5	---	S

**Dynamic and switching Characteristics**

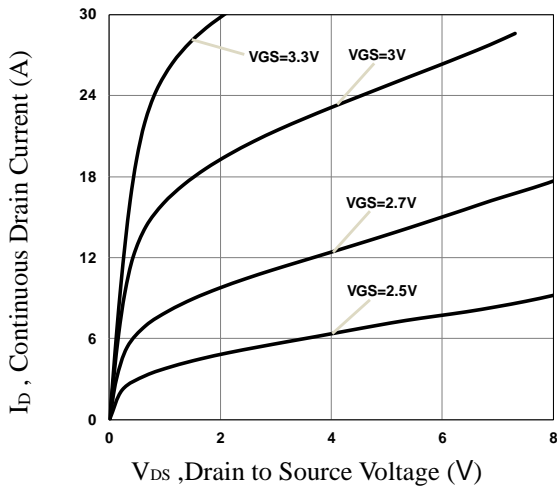
Q <sub>g</sub>	Total Gate Charge <sup>3, 4</sup>	V <sub>DS</sub> =15V , V <sub>GS</sub> =10V , I <sub>D</sub> =15A	---	11.5	18	nC
Q <sub>gs</sub>	Gate-Source Charge <sup>3, 4</sup>		---	1.3	3	
Q <sub>gd</sub>	Gate-Drain Charge <sup>3, 4</sup>		---	3.2	5	
T <sub>d(on)</sub>	Turn-On Delay Time <sup>3, 4</sup>	V <sub>DD</sub> =15V , V <sub>GS</sub> =10V , R <sub>G</sub> =6Ω I <sub>D</sub> =15A	---	4	6	ns
T <sub>r</sub>	Rise Time <sup>3, 4</sup>		---	10	15	
T <sub>d(off)</sub>	Turn-Off Delay Time <sup>3, 4</sup>		---	22	33	
T <sub>f</sub>	Fall Time <sup>3, 4</sup>		---	7	11	
C <sub>iss</sub>	Input Capacitance	V <sub>DS</sub> =15V , V <sub>GS</sub> =0V , F=1MHz	---	720	1080	pF
C <sub>oss</sub>	Output Capacitance		---	100	150	
C <sub>rss</sub>	Reverse Transfer Capacitance		---	85	130	
R <sub>g</sub>	Gate resistance	V <sub>GS</sub> =0V , V <sub>DS</sub> =0V , F=1MHz	---	2.7	---	Ω

**Drain-Source Diode Characteristics and Maximum Ratings**

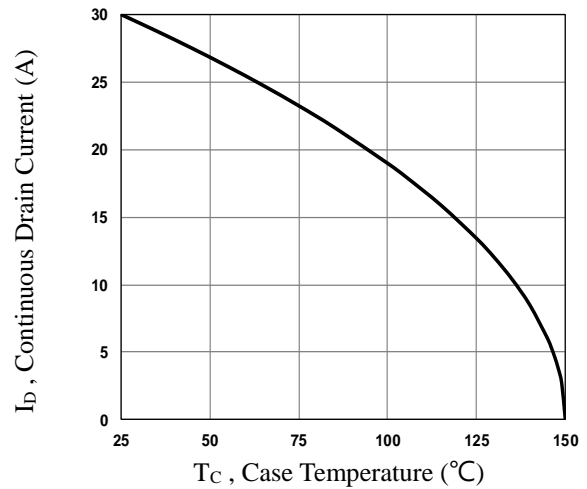
Symbol	Parameter	Conditions	Min.	Typ.	Max.	Unit
I <sub>S</sub>	Continuous Source Current	V <sub>G</sub> =V <sub>D</sub> =0V , Force Current	---	---	30	A
I <sub>SM</sub>	Pulsed Source Current		---	---	60	A
V <sub>SD</sub>	Diode Forward Voltage	V <sub>GS</sub> =0V , I <sub>S</sub> =1A , T <sub>J</sub> =25°C	---	---	1	V
t <sub>rr</sub>	Reverse Recovery Time	V <sub>R</sub> =30V , I <sub>S</sub> =10A	---	110	---	ns
Q <sub>rr</sub>	Reverse Recovery Charge	di/dt=100A/μs , T <sub>J</sub> =25°C	---	140	---	nC

Note :

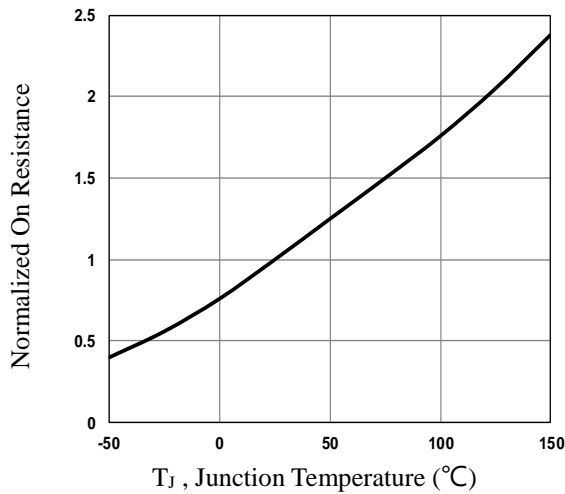
1. Repetitive Rating : Pulsed width limited by maximum junction temperature.
2. V<sub>DD</sub>=25V, V<sub>GS</sub>=10V, L=0.1mH, I<sub>AS</sub>=20A., R<sub>G</sub>=25Ω, Starting T<sub>J</sub>=25°C.
3. The data tested by pulsed , pulse width ≤ 300us , duty cycle ≤ 2%.
4. Essentially independent of operating temperature.



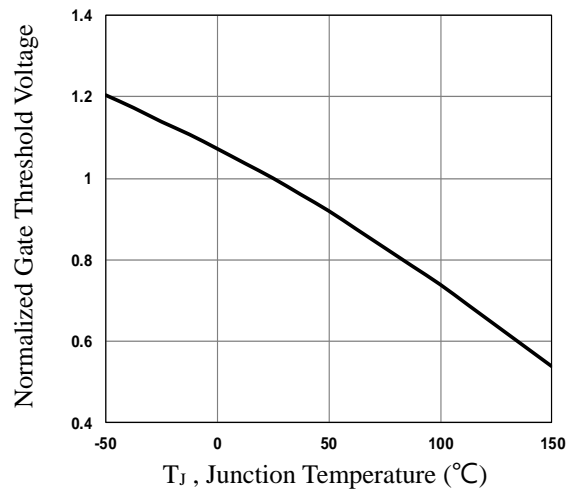
**Fig.1 Typical Output Characteristics**



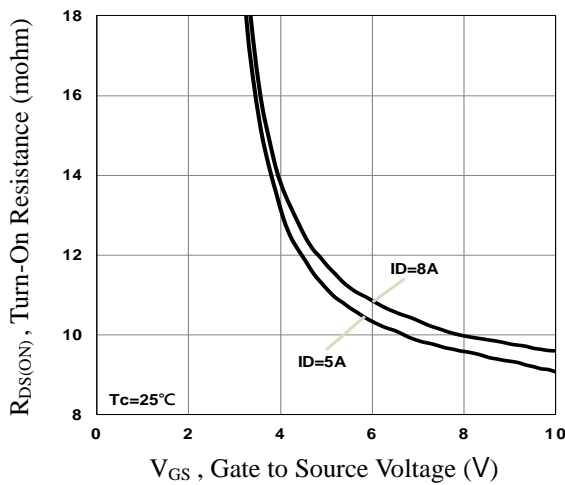
**Fig.2 Continuous Drain Current vs. T<sub>c</sub>**



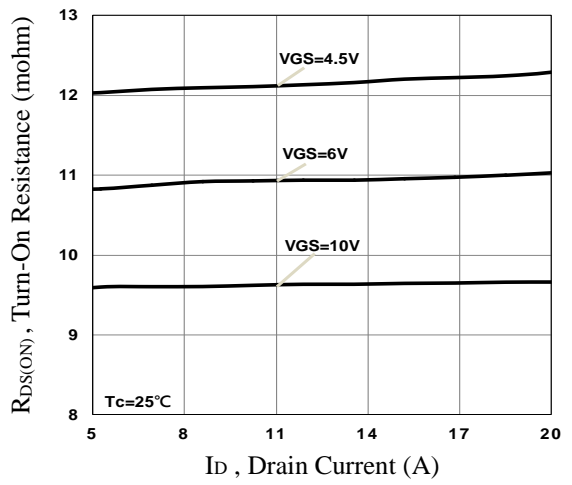
**Fig.3 Normalized R<sub>DS(on)</sub> vs. T<sub>j</sub>**



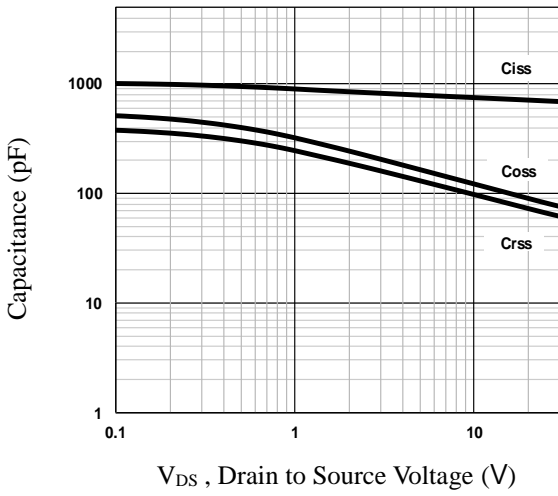
**Fig.4 Normalized V<sub>th</sub> vs. T<sub>j</sub>**



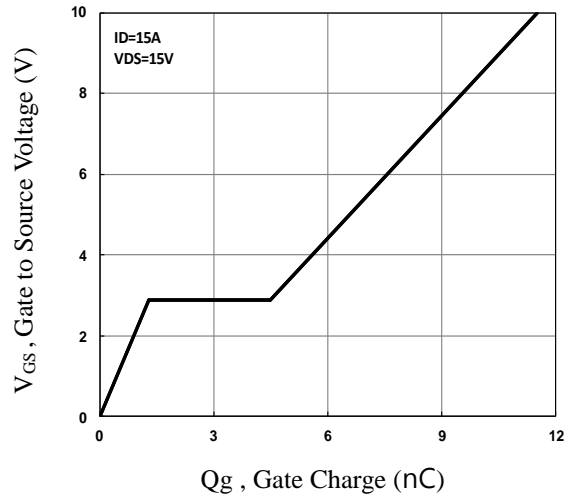
**Fig.5 Turn-On Resistance vs. V<sub>GS</sub>**



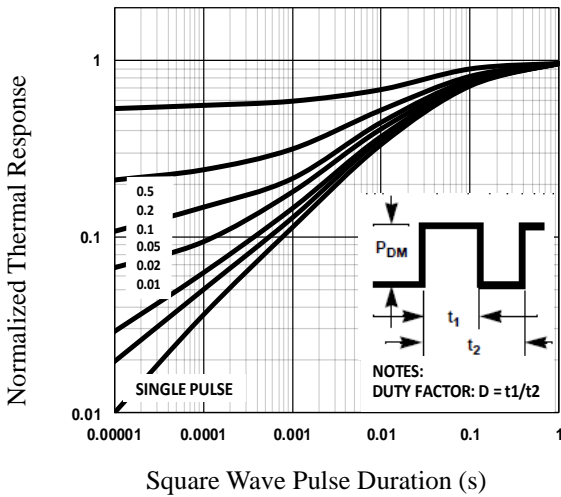
**Fig.6 Turn-On Resistance vs. I<sub>D</sub>**



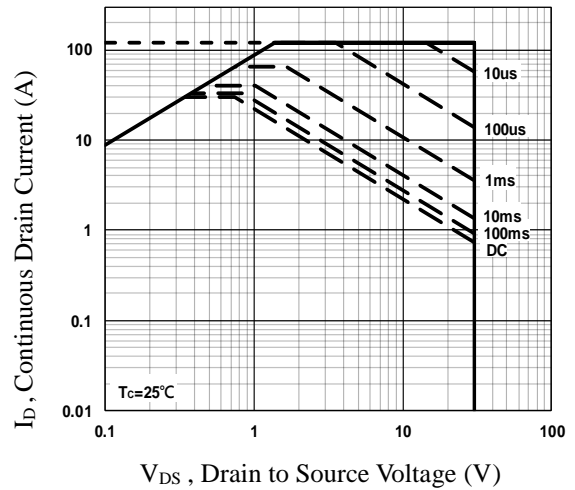
**Fig.7 Capacitance Characteristics**



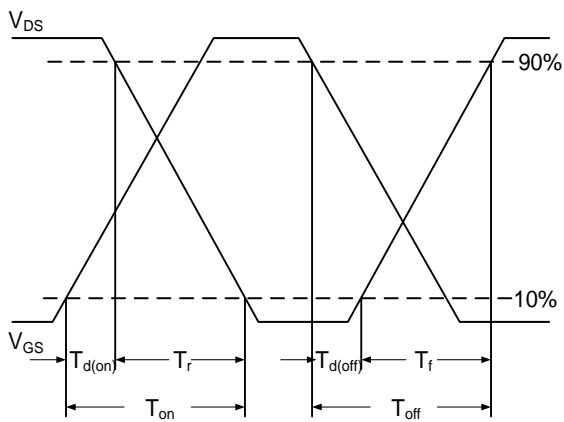
**Fig.8 Gate Charge Characteristics**



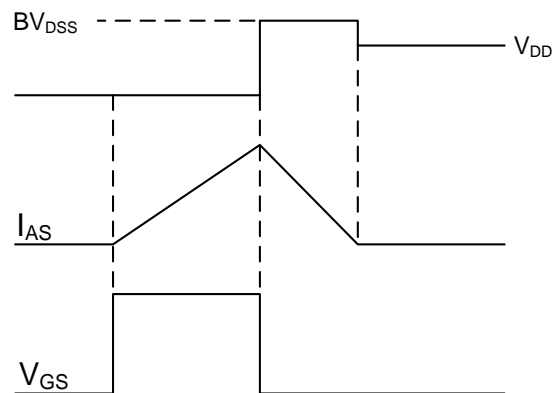
**Fig.9 Normalized Transient Impedance**



**Fig.10 Maximum Safe Operation Area**



**Fig.11 Switching Time Waveform**



**Fig.12 EAS Waveform**

**P-CH Electrical Characteristics (T<sub>J</sub>=25 °C, unless otherwise noted)**
**Off Characteristics**

Symbol	Parameter	Conditions	Min.	Typ.	Max.	Unit
BV <sub>DSS</sub>	Drain-Source Breakdown Voltage	V <sub>GS</sub> =0V, I <sub>D</sub> =-250uA	-30	---	---	V
I <sub>DSS</sub>	Drain-Source Leakage Current	V <sub>DS</sub> =-30V, V <sub>GS</sub> =0V, T <sub>J</sub> =25°C	---	---	-1	uA
		V <sub>DS</sub> =-24V, V <sub>GS</sub> =0V, T <sub>J</sub> =125°C	---	---	-10	uA
I <sub>GSS</sub>	Gate-Source Leakage Current	V <sub>GS</sub> =±20V, V <sub>DS</sub> =0V	---	---	±100	nA

**On Characteristics**

R <sub>DS(ON)</sub>	Static Drain-Source On-Resistance	V <sub>GS</sub> =-10V, I <sub>D</sub> =-8A	---	19	23	mΩ
		V <sub>GS</sub> =-4.5V, I <sub>D</sub> =-5A	---	29	35	mΩ
V <sub>GS(th)</sub>	Gate Threshold Voltage	V <sub>GS</sub> =V <sub>DS</sub> , I <sub>D</sub> =-250uA	-1.2	-1.5	-2.5	V
g <sub>fs</sub>	Forward Transconductance	V <sub>DS</sub> =-10V, I <sub>D</sub> =-3A	---	4	---	S

**Dynamic and switching Characteristics**

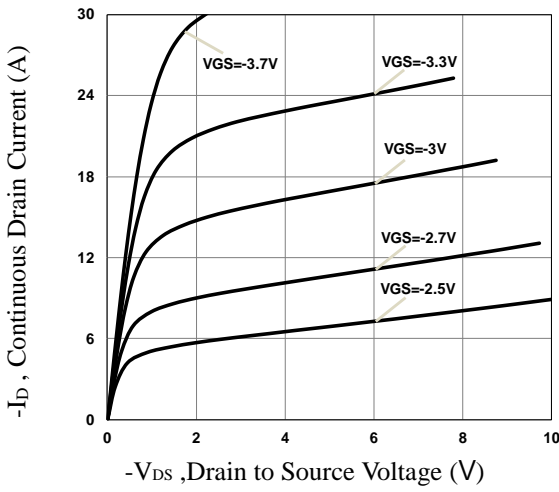
Q <sub>g</sub>	Total Gate Charge <sup>7,8</sup>	V <sub>DS</sub> =-15V, V <sub>GS</sub> =-10V, I <sub>D</sub> =-15A	---	18.5	28	nC
Q <sub>gs</sub>	Gate-Source Charge <sup>7,8</sup>		---	2.5	4	
Q <sub>gd</sub>	Gate-Drain Charge <sup>7,8</sup>		---	4.3	7	
T <sub>d(on)</sub>	Turn-On Delay Time <sup>7,8</sup>	V <sub>DD</sub> =-15V, V <sub>GS</sub> =-10V, R <sub>G</sub> =6Ω I <sub>D</sub> =-15A	---	7.2	11	ns
T <sub>r</sub>	Rise Time <sup>7,8</sup>		---	38	57	
T <sub>d(off)</sub>	Turn-Off Delay Time <sup>7,8</sup>		---	34	51	
T <sub>f</sub>	Fall Time <sup>7,8</sup>		---	8.2	12	
C <sub>iss</sub>	Input Capacitance	V <sub>DS</sub> =-15V, V <sub>GS</sub> =0V, F=1MHz	---	1100	1650	pF
C <sub>oss</sub>	Output Capacitance		---	175	260	
C <sub>rss</sub>	Reverse Transfer Capacitance		---	130	195	
R <sub>g</sub>	Gate resistance	V <sub>GS</sub> =0V, V <sub>DS</sub> =0V, F=1MHz	---	13	---	Ω

**Drain-Source Diode Characteristics and Maximum Ratings**

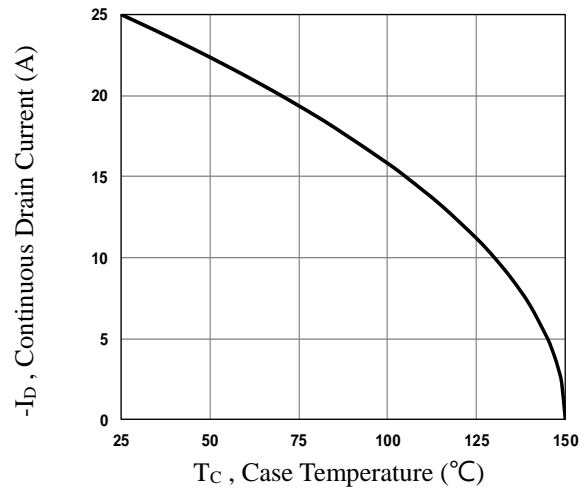
Symbol	Parameter	Conditions	Min.	Typ.	Max.	Unit
I <sub>S</sub>	Continuous Source Current	V <sub>G</sub> =V <sub>D</sub> =0V, Force Current	---	---	-25	A
I <sub>SM</sub>	Pulsed Source Current		---	---	-50	A
V <sub>SD</sub>	Diode Forward Voltage	V <sub>GS</sub> =0V, I <sub>S</sub> =-1A, T <sub>J</sub> =25°C	---	---	-1	V
t <sub>rr</sub>	Reverse Recovery Time	V <sub>R</sub> =-30V, I <sub>S</sub> =-10A	---	150	---	ns
Q <sub>rr</sub>	Reverse Recovery Charge	di/dt=100A/μs, T <sub>J</sub> =25°C	---	260	---	nC

Note :

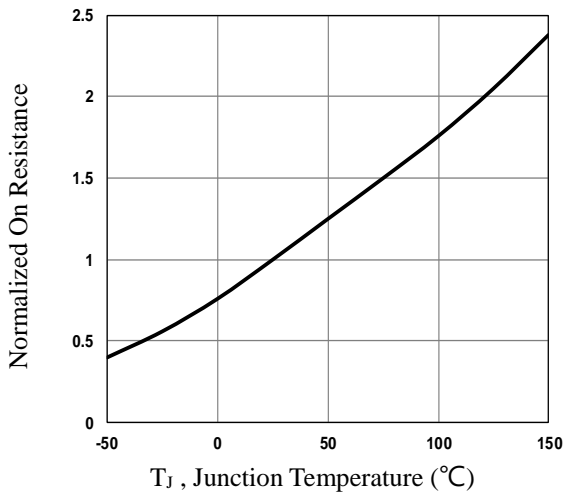
5. Repetitive Rating : Pulsed width limited by maximum junction temperature.
6. V<sub>DD</sub>=-25V, V<sub>GS</sub>=-10V, L=0.1mH, I<sub>AS</sub>=-30A., R<sub>G</sub>=25Ω, Starting T<sub>J</sub>=25°C
7. The data tested by pulsed , pulse width ≤ 300us , duty cycle ≤ 2%.
8. Essentially independent of operating temperature.



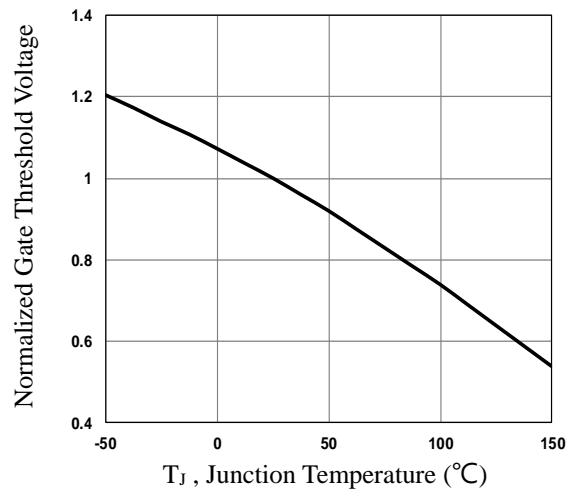
**Fig.13 Typical Output Characteristics**



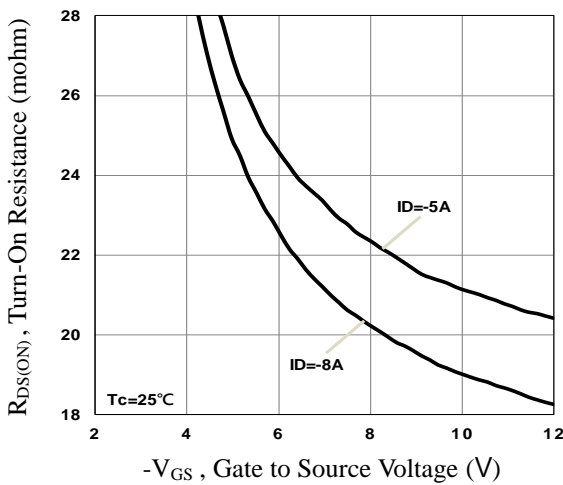
**Fig.14 Continuous Drain Current vs.  $T_c$**



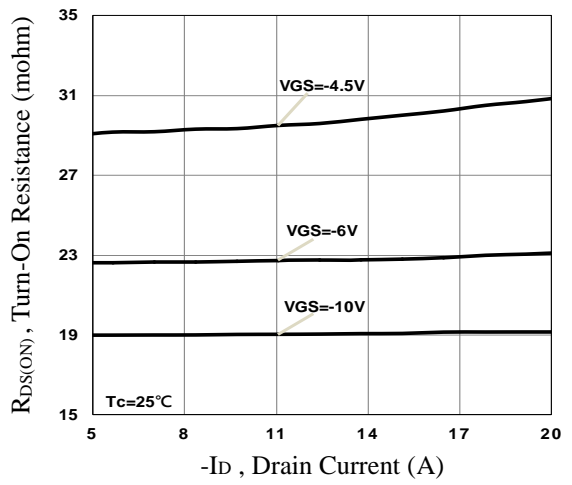
**Fig.15 Normalized  $R_{DS(on)}$  vs.  $T_J$**



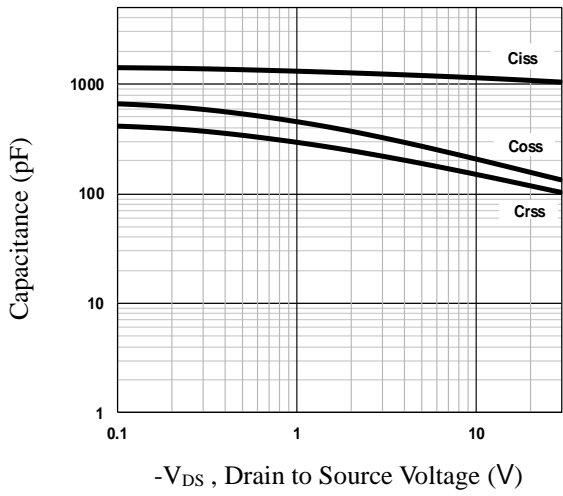
**Fig.16 Normalized  $V_{th}$  vs.  $T_J$**



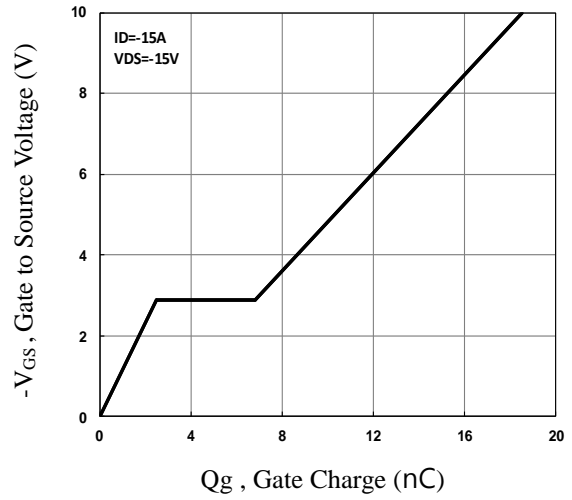
**Fig.17 Turn-On Resistance vs.  $V_{GS}$**



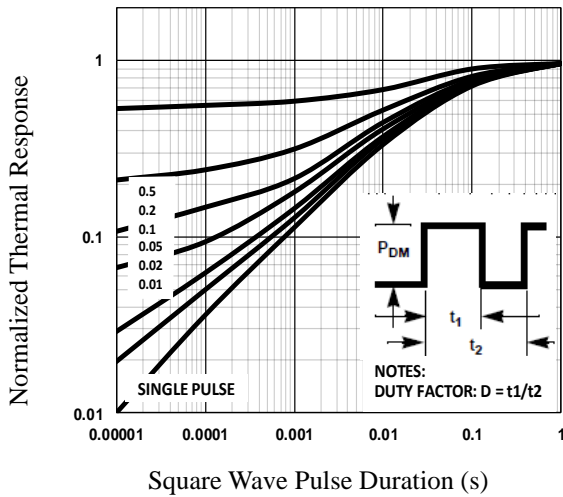
**Fig.18 Turn-On Resistance vs.  $I_D$**



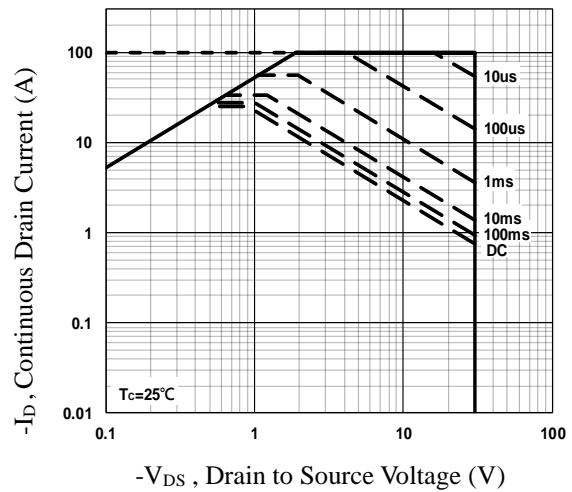
**Fig.19 Capacitance Characteristics**



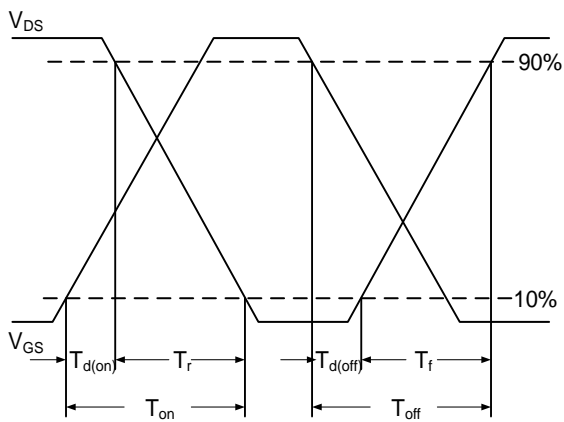
**Fig.20 Gate Charge Characteristics**



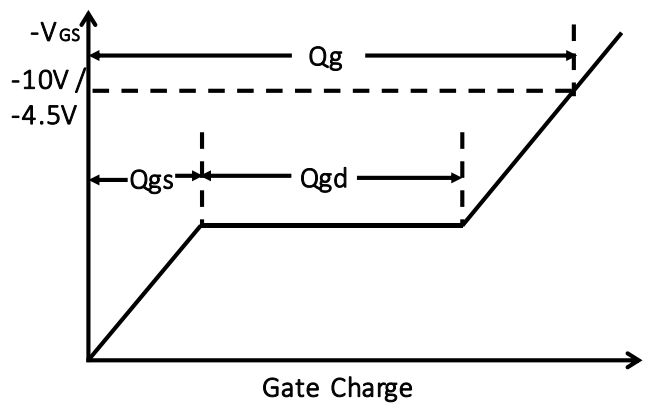
**Fig.21 Normalized Transient Impedance**



**Fig.22 Maximum Safe Operation Area**

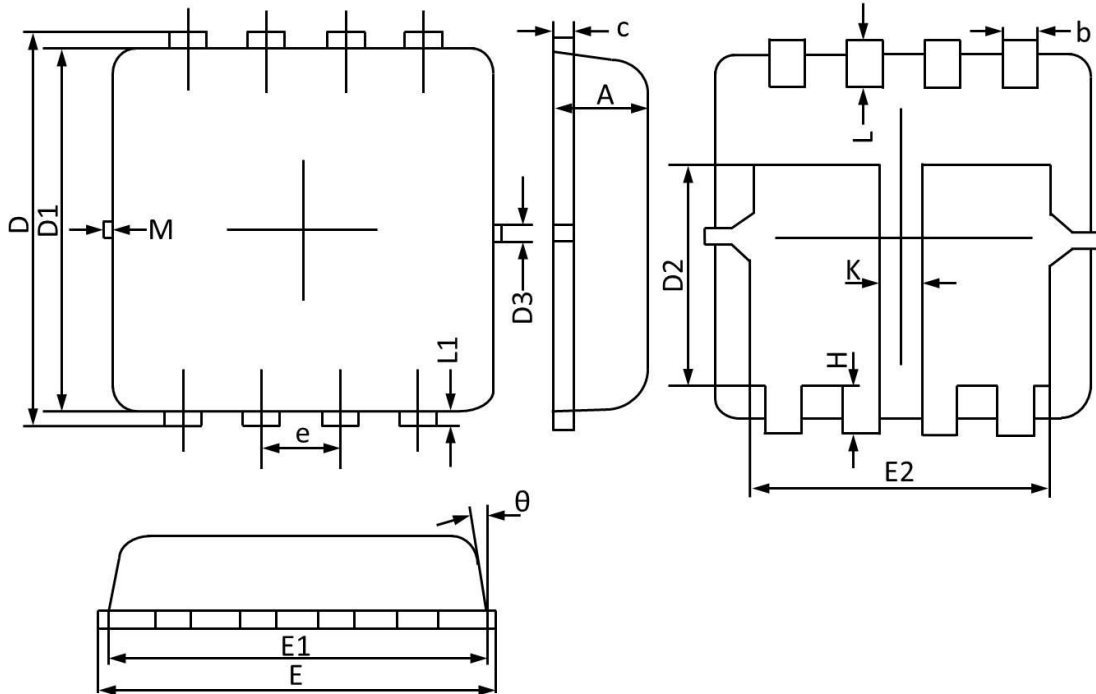


**Fig.23 Switching Time Waveform**



**Fig.24 Gate Charge Waveform**

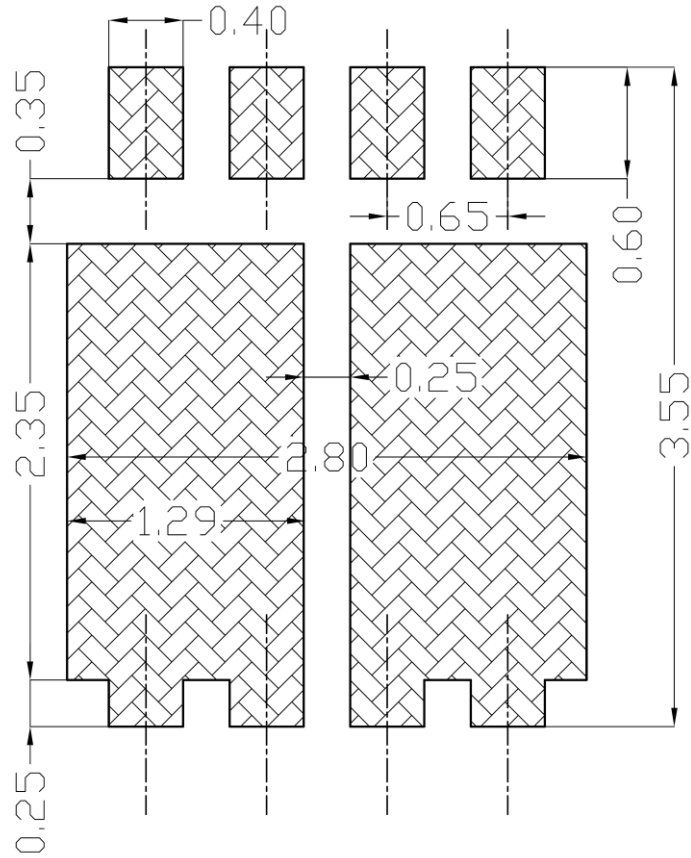
PPAK3x3 Dual PACKAGE INFORMATION



Symbol	Dimensions In Millimeters		Dimensions In Inches	
	Min	Max	Min	Max
A	0.670	0.880	0.026	0.035
b	0.250	0.350	0.010	0.014
c	0.100	0.250	0.004	0.010
D	3.150	3.550	0.124	0.140
D1	3.000	3.300	0.118	0.130
D2	1.500	2.000	0.059	0.079
D3	0.130	0.200	0.005	0.008
E	3.100	3.500	0.122	0.138
E1	3.000	3.200	0.118	0.126
E2	2.350	2.600	0.093	0.102
e	0.650 BSC		0.026 BSC	
H	0.300	0.500	0.012	0.020
L	0.300	0.500	0.012	0.020
L1	0.130 REF		0.005 REF	
K	0.300 REF		0.012 REF	
theta	0°	12°	0°	12°
M	0.150 REF		0.006 REF	



PPAK3X3 Dual RECOMMENDED LAND PATTERN



unit : mm