

**General Description**

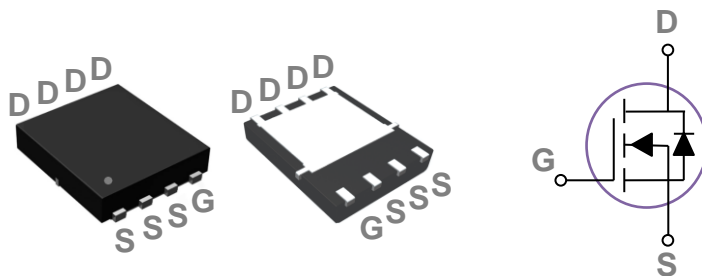
These N-Channel enhancement mode power field effect transistors are using trench DMOS technology. This advanced technology has been especially tailored to minimize on-state resistance, provide superior switching performance, and withstand high energy pulse in the avalanche and commutation mode. These devices are well suited for high efficiency fast switching applications.

BVDSS	RDSON	ID
150V	43mΩ	25A

**Features**

- 150V,25A, RDS(ON) =43mΩ @VGS = 10V
- Improved dv/dt capability
- Fast switching
- 100% EAS Guaranteed
- Green Device Available

**PPAK5X6 Pin Configuration**



**Applications**

- Motor Drive
- Power Tools
- LED Lighting

**Absolute Maximum Ratings** Tc=25°C unless otherwise noted

Symbol	Parameter	Rating	Units
V <sub>DS</sub>	Drain-Source Voltage	150	V
V <sub>GS</sub>	Gate-Source Voltage	±20	V
I <sub>D</sub>	Drain Current – Continuous (T <sub>C</sub> =25°C)	25	A
	Drain Current – Continuous (T <sub>C</sub> =100°C)	16	A
I <sub>DM</sub>	Drain Current – Pulsed <sup>1</sup>	100	A
EAS	Single Pulse Avalanche Energy <sup>2</sup>	29	mJ
IAS	Single Pulse Avalanche Current <sup>2</sup>	24	A
P <sub>D</sub>	Power Dissipation (T <sub>C</sub> =25°C)	101	W
	Power Dissipation – Derate above 25°C	0.81	W/°C
T <sub>STG</sub>	Storage Temperature Range	-55 to 150	°C
T <sub>J</sub>	Operating Junction Temperature Range	-55 to 150	°C

**Thermal Characteristics**

Symbol	Parameter	Typ.	Max.	Unit
R <sub>θJA</sub>	Thermal Resistance Junction to ambient	---	62	°C/W
R <sub>θJC</sub>	Thermal Resistance Junction to Case	---	1.23	°C/W

**Electrical Characteristics (T<sub>J</sub>=25 °C, unless otherwise noted)**
**Off Characteristics**

Symbol	Parameter	Conditions	Min.	Typ.	Max.	Unit
BV <sub>DSS</sub>	Drain-Source Breakdown Voltage	V <sub>GS</sub> =0V, I <sub>D</sub> =250μA	150	---	---	V
I <sub>DSS</sub>	Drain-Source Leakage Current	V <sub>DS</sub> =120V, V <sub>GS</sub> =0V, T <sub>J</sub> =25°C	---	---	1	μA
		V <sub>DS</sub> =120V, V <sub>GS</sub> =0V, T <sub>J</sub> =85°C	---	---	10	μA
I <sub>GSS</sub>	Gate-Source Leakage Current	V <sub>GS</sub> =±20V, V <sub>DS</sub> =0V	---	---	±100	nA

**On Characteristics**

R <sub>DS(ON)</sub>	Static Drain-Source On-Resistance <sup>3, 4</sup>	V <sub>GS</sub> =10V, I <sub>D</sub> =20A	---	36	43	mΩ
V <sub>GS(th)</sub>	Gate Threshold Voltage	V <sub>GS</sub> =V <sub>DS</sub> , I <sub>D</sub> =250μA	2.5	3.5	4.5	V
g <sub>fs</sub>	Forward Transconductance	V <sub>DS</sub> =10V, I <sub>D</sub> =3A	---	7	---	S

**Dynamic and switching Characteristics**

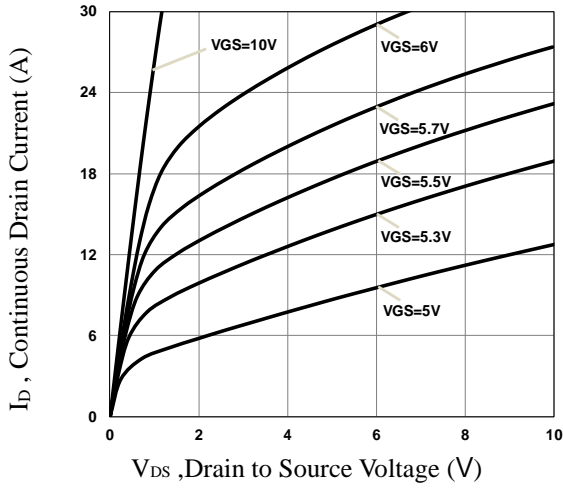
Q <sub>g</sub>	Total Gate Charge <sup>3, 4</sup>	V <sub>DS</sub> =75V, V <sub>GS</sub> =10V, I <sub>D</sub> =15A	---	17.4	30	nC
Q <sub>gs</sub>	Gate-Source Charge <sup>3, 4</sup>		---	2.7	5	
Q <sub>gd</sub>	Gate-Drain Charge <sup>3, 4</sup>		---	6.1	10	
T <sub>d(on)</sub>	Turn-On Delay Time <sup>3, 4</sup>	V <sub>DD</sub> =75V, V <sub>GS</sub> =10V, R <sub>G</sub> =6Ω I <sub>D</sub> =15A	---	4.6	10	ns
T <sub>r</sub>	Rise Time <sup>3, 4</sup>		---	15	25	
T <sub>d(off)</sub>	Turn-Off Delay Time <sup>3, 4</sup>		---	27	45	
T <sub>f</sub>	Fall Time <sup>3, 4</sup>		---	8	15	
C <sub>iss</sub>	Input Capacitance	V <sub>DS</sub> =75V, V <sub>GS</sub> =0V, F=1MHz	---	835	1300	pF
C <sub>oss</sub>	Output Capacitance		---	75	120	
C <sub>rss</sub>	Reverse Transfer Capacitance		---	7	15	
R <sub>g</sub>	Gate Resistance	V <sub>GS</sub> =0V, V <sub>DS</sub> =0V, F=1MHz	---	0.8	---	Ω

**Drain-Source Diode Characteristics and Maximum Ratings**

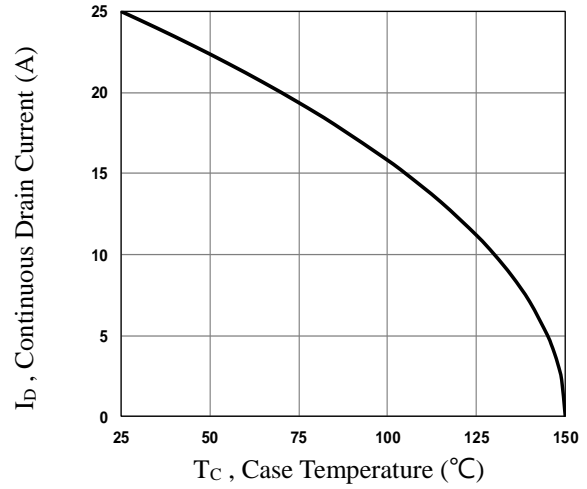
Symbol	Parameter	Conditions	Min.	Typ.	Max.	Unit
I <sub>S</sub>	Continuous Source Current	V <sub>G</sub> =V <sub>D</sub> =0V, Force Current	---	---	25	A
I <sub>SM</sub>	Pulsed Source Current		---	---	50	A
V <sub>SD</sub>	Diode Forward Voltage	V <sub>GS</sub> =0V, I <sub>S</sub> =1A, T <sub>J</sub> =25°C	---	---	1	V
t <sub>rr</sub>	Reverse Recovery Time	V <sub>R</sub> =100V, I <sub>S</sub> =10A,	---	70	---	ns
Q <sub>rr</sub>	Reverse Recovery Charge	di/dt=100A/μs, T <sub>J</sub> =25°C	---	250	---	nC

Note :

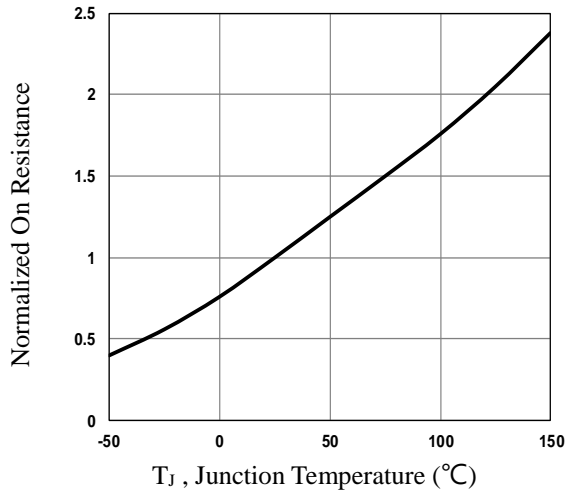
1. Repetitive Rating : Pulsed width limited by maximum junction temperature.
2. V<sub>DD</sub>=50V, L=0.1mH, I<sub>AS</sub>=24A., R<sub>G</sub>=25Ω, Starting T<sub>J</sub>=25°C.
3. The data tested by pulsed, pulse width ≤ 300us, duty cycle ≤ 2%.
4. Essentially independent of operating temperature.



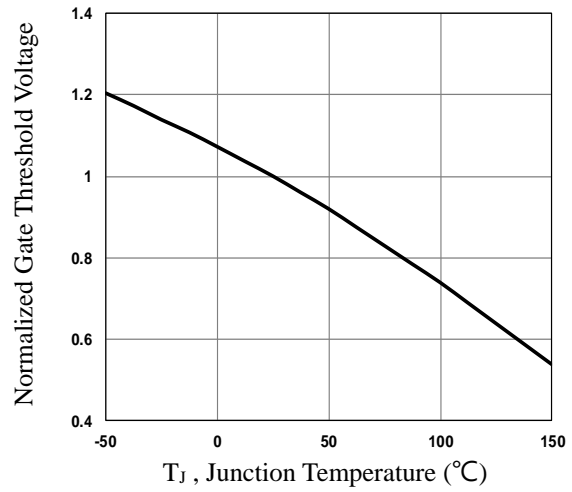
**Fig.1 Typical Output Characteristics**



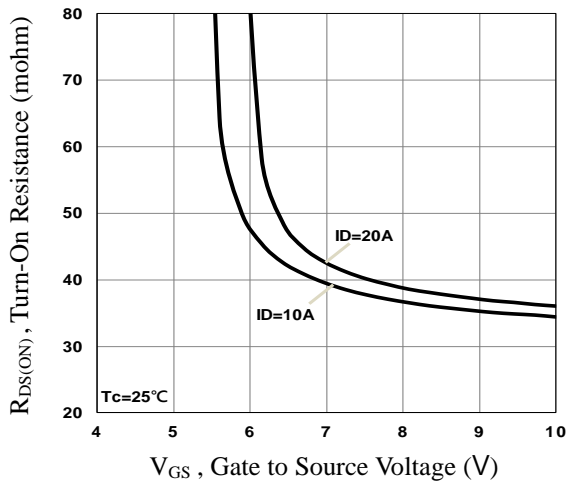
**Fig.2 Continuous Drain Current vs.  $T_c$**



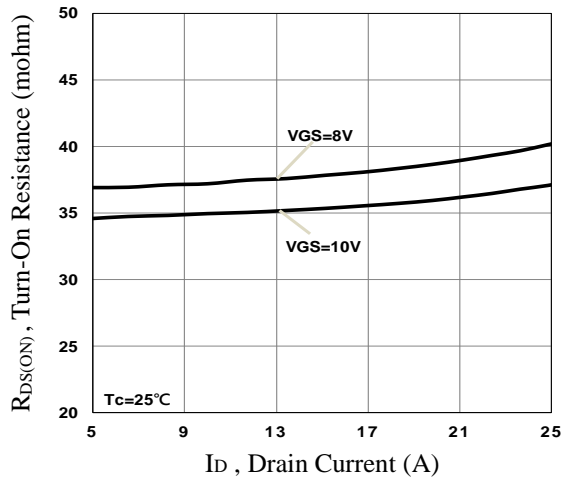
**Fig.3 Normalized  $R_{DS(on)}$  vs.  $T_J$**



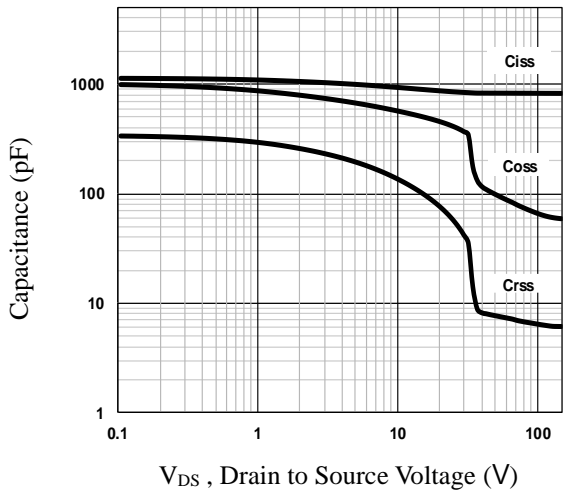
**Fig.4 Normalized  $V_{th}$  vs.  $T_J$**



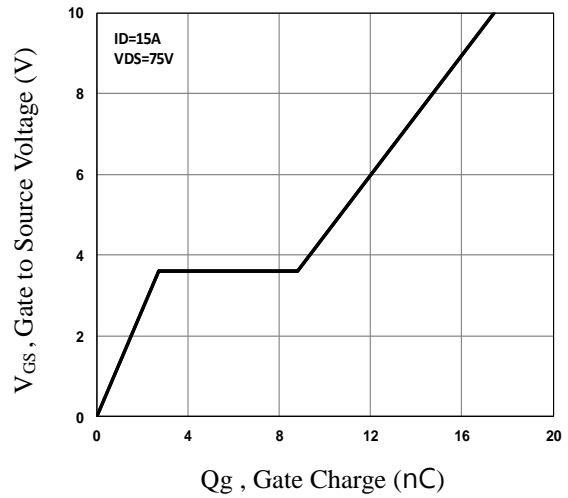
**Fig.5 Turn-On Resistance vs.  $V_{GS}$**



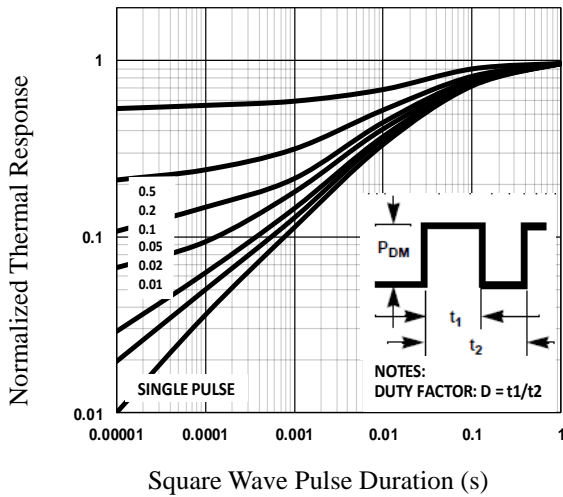
**Fig.6 Turn-On Resistance vs.  $I_D$**



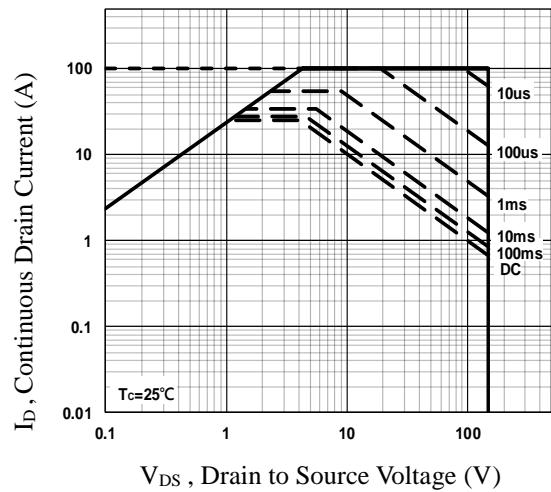
**Fig.7 Capacitance Characteristics**



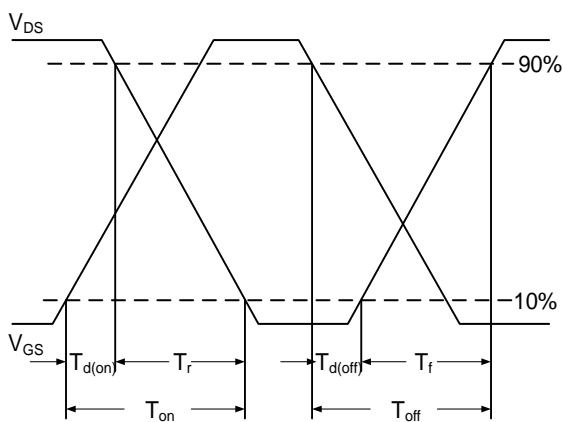
**Fig.8 Gate Charge Characteristics**



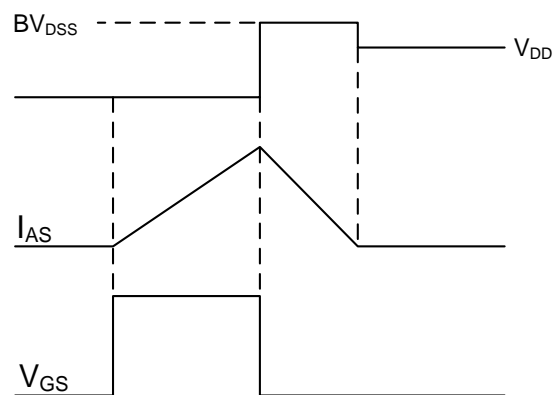
**Fig.9 Normalized Transient Impedance**



**Fig.10 Maximum Safe Operation Area**

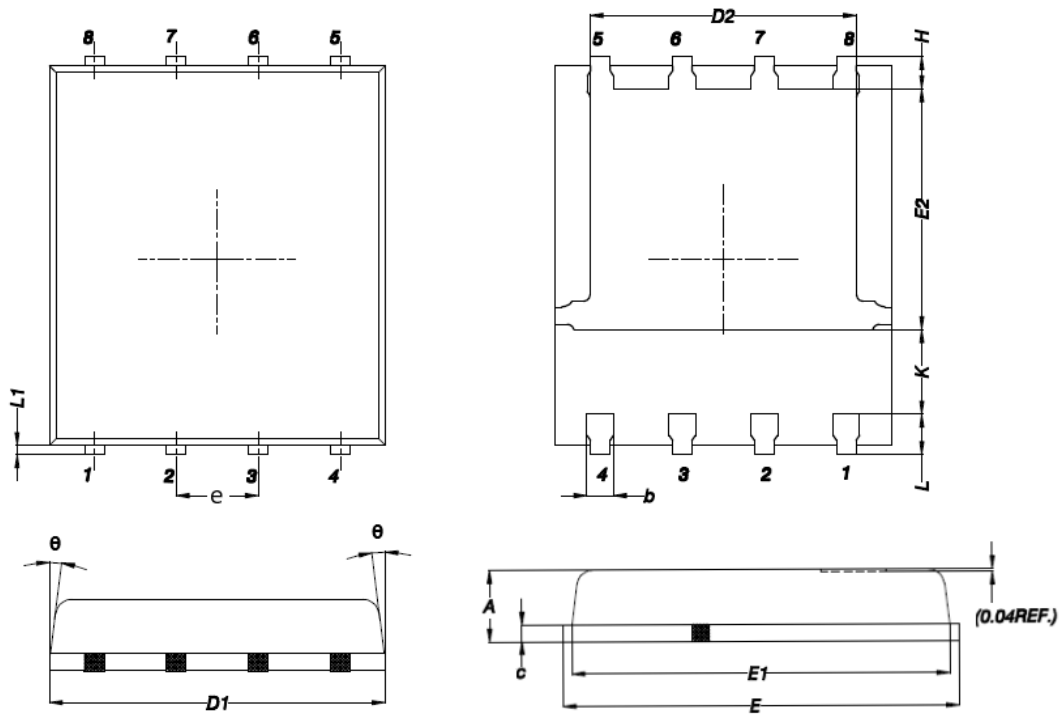


**Fig.11 Switching Time Waveform**



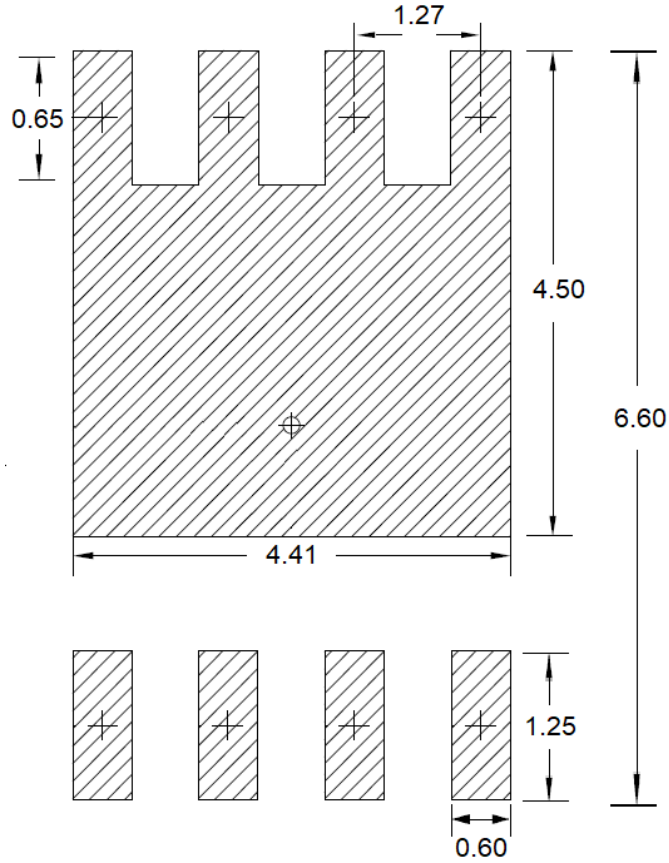
**Fig.12 EAS Waveform**

**PPAK5x6 PACKAGE INFORMATION**



Symbol	Dimensions In Millimeters		Dimensions In Inches	
	MAX	MIN	MAX	MIN
A	1.200	0.850	0.047	0.031
b	0.510	0.300	0.020	0.012
C	0.300	0.200	0.012	0.008
D1	5.400	4.800	0.212	0.189
D2	4.310	3.610	0.170	0.142
E	6.300	5.850	0.248	0.230
E1	5.960	5.450	0.235	0.215
E2	3.920	3.300	0.154	0.130
e	1.27BSC		0.05BSC	
H	0.650	0.380	0.026	0.015
K	---	1.100	---	0.043
L	0.710	0.380	0.028	0.015
L1	0.250	0.050	0.009	0.002
θ	12°	0°	12°	0°

### PPAK5X6 RECOMMENDED LAND PATTERN



unit : mm