

General Description

These P-Channel enhancement mode power field effect transistors are using trench DMOS technology. This advanced technology has been especially tailored to minimize on-state resistance, provide superior switching performance, and withstand high energy pulse in the avalanche and commutation mode. These devices are well suited for high efficiency fast switching applications.

PPAK3X3 Pin Configuration

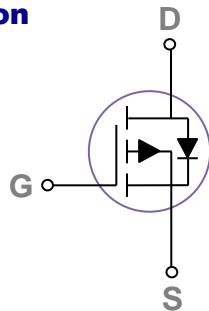
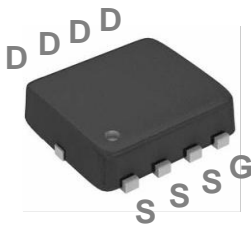

| | | |
|-------|-------|-----|
| BVDSS | RDSON | ID |
| -150V | 780mΩ | -2A |

Features

- -150V,-2A, $R_{DS(ON)} = 780m\Omega @ V_{GS} = -10V$
- Improved dv/dt capability
- Fast switching
- 100% EAS Guaranteed
- Green Device Available

Applications

- Networking
- Load Switch
- LED applications

Absolute Maximum Ratings $T_c=25^\circ C$ unless otherwise noted

| Symbol | Parameter | Rating | Units |
|-----------|--|------------|---------------|
| V_{DS} | Drain-Source Voltage | -150 | V |
| V_{GS} | Gate-Source Voltage | ± 20 | V |
| I_D | Drain Current – Continuous ($T_c=25^\circ C$) | -2 | A |
| | Drain Current – Continuous ($T_c=100^\circ C$) | -1.3 | A |
| I_{DM} | Drain Current – Pulsed ¹ | -8 | A |
| EAS | Single Pulse Avalanche Energy ² | 11.5 | mJ |
| IAS | Single Pulse Avalanche Current ² | 4.8 | A |
| P_D | Power Dissipation ($T_c=25^\circ C$) | 7.8 | W |
| | Power Dissipation – Derate above $25^\circ C$ | 0.06 | W/ $^\circ C$ |
| T_{STG} | Storage Temperature Range | -50 to 150 | $^\circ C$ |
| T_J | Operating Junction Temperature Range | -50 to 150 | $^\circ C$ |

Thermal Characteristics

| Symbol | Parameter | Typ. | Max. | Unit |
|-----------------|--|------|------|--------------|
| $R_{\theta JA}$ | Thermal Resistance Junction to ambient | --- | 62 | $^\circ C/W$ |
| $R_{\theta JC}$ | Thermal Resistance Junction to Case | --- | 16 | $^\circ C/W$ |

Electrical Characteristics (T_J=25 °C, unless otherwise noted)
Off Characteristics

| Symbol | Parameter | Conditions | Min. | Typ. | Max. | Unit |
|-------------------------------------|---|--|------|------|------|------|
| BV _{DSS} | Drain-Source Breakdown Voltage | V _{GS} =0V, I _D =-250uA | -150 | --- | --- | V |
| ΔBV _{DSS} /ΔT _J | BV _{DSS} Temperature Coefficient | Reference to 25°C, I _D =1mA | --- | 0.12 | --- | V/°C |
| I _{DSS} | Drain-Source Leakage Current | V _{DS} =-150V, V _{GS} =0V, T _J =25°C | --- | --- | -1 | uA |
| | | V _{DS} =-120V, V _{GS} =0V, T _J =125°C | --- | --- | -10 | uA |
| I _{GSS} | Gate-Source Leakage Current | V _{GS} =±20V, V _{DS} =0V | --- | --- | ±100 | nA |

On Characteristics

| | | | | | | |
|----------------------|---|---|-----|-------|-----|-------|
| R _{DS(ON)} | Static Drain-Source On-Resistance | V _{GS} =-10V, I _D =-1A | --- | 650 | 780 | mΩ |
| | | V _{GS} =-6V, I _D =-0.5A | --- | 700 | 950 | mΩ |
| V _{GS(th)} | Gate Threshold Voltage | V _{GS} =V _{DS} , I _D =-250uA | -2 | -3 | -4 | V |
| ΔV _{GS(th)} | V _{GS(th)} Temperature Coefficient | | --- | -5.81 | --- | mV/°C |
| g _{fs} | Forward Transconductance | V _{DS} =-10V, I _D =-1A | --- | 2 | --- | S |

Dynamic and switching Characteristics

| | | | | | | |
|---------------------|-------------------------------------|--|--|------|-----|----|
| Q _g | Total Gate Charge ^{3, 4} | V _{DS} =-75V, V _{GS} =10V, I _D =-1A | --- | 4.4 | 8 | nC |
| Q _{gs} | Gate-Source Charge ^{3, 4} | | --- | 0.7 | 2 | |
| Q _{gd} | Gate-Drain Charge ^{3, 4} | | --- | 1.5 | 3 | |
| T _{d(on)} | Turn-On Delay Time ^{3, 4} | V _{DD} =-75V, V _{GS} =-10V, R _G =10Ω I _D =-1A | --- | 12.5 | 20 | ns |
| T _r | Rise Time ^{3, 4} | | --- | 8.9 | 18 | |
| T _{d(off)} | Turn-Off Delay Time ^{3, 4} | | --- | 17.3 | 36 | |
| T _f | Fall Time ^{3, 4} | | --- | 11.5 | 24 | |
| C _{iss} | Input Capacitance | V _{DS} =-75V, V _{GS} =0V, F=1MHz | --- | 403 | 810 | pF |
| C _{oss} | Output Capacitance | | --- | 31 | 65 | |
| C _{rss} | Reverse Transfer Capacitance | | --- | 18 | 40 | |
| R _g | Gate resistance | | V _{GS} =0V, V _{DS} =0V, F=1MHz | --- | 30 | |

Drain-Source Diode Characteristics and Maximum Ratings

| Symbol | Parameter | Conditions | Min. | Typ. | Max. | Unit |
|-----------------|---------------------------|--|------|------|------|------|
| I _S | Continuous Source Current | V _G =V _D =0V, Force Current | --- | --- | -2 | A |
| I _{SM} | Pulsed Source Current | | --- | --- | -4 | A |
| V _{SD} | Diode Forward Voltage | V _{GS} =0V, I _S =-1A, T _J =25°C | --- | --- | -1 | V |
| t _{rr} | Reverse Recovery Time | V _{GS} =0V, I _S =1A, di/dt=100A/μs | --- | 70 | --- | ns |
| Q _{rr} | Reverse Recovery Charge | T _J =25°C | --- | 114 | --- | nC |

Note :

1. Repetitive Rating : Pulsed width limited by maximum junction temperature.
2. V_{DD}=50V, V_{GS}=10V, L=1mH, I_{AS}=4.8A., R_G=25Ω, Starting T_J=25°C.
3. The data tested by pulsed, pulse width ≤ 300us, duty cycle ≤ 2%.
4. Essentially independent of operating temperature.

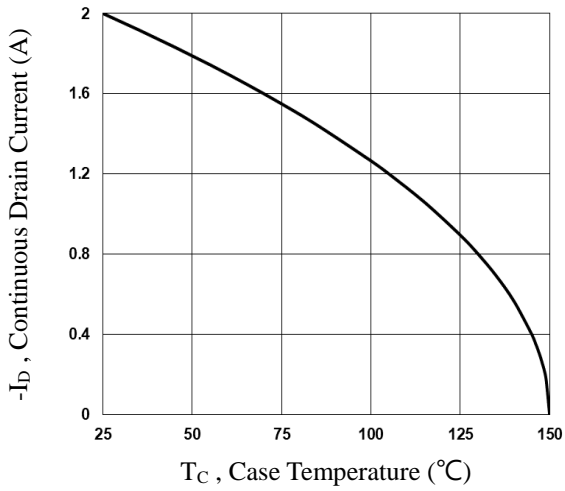

Fig.1 Continuous Drain Current vs. T_c

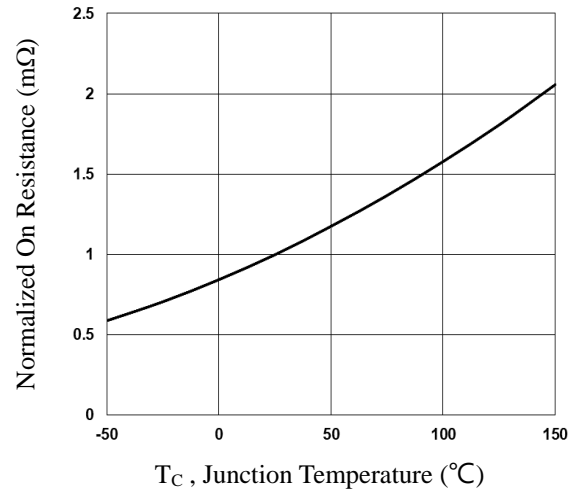

Fig.2 Continuous Drain Current vs. T_j

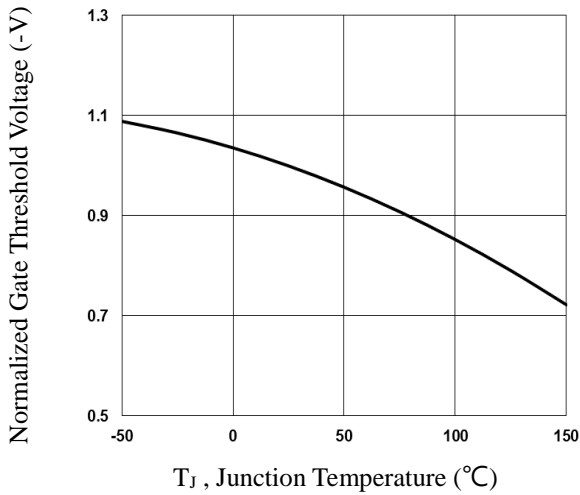

Fig.3 Normalized V_{th} vs. T_j

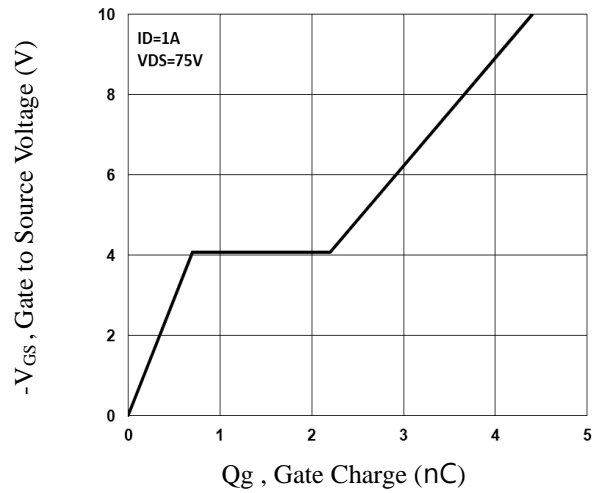

Fig.4 Gate Charge Waveform

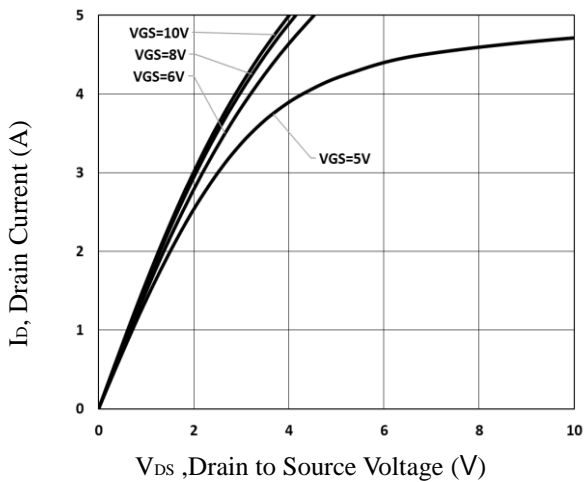

Fig.5 Typical Output Characteristics

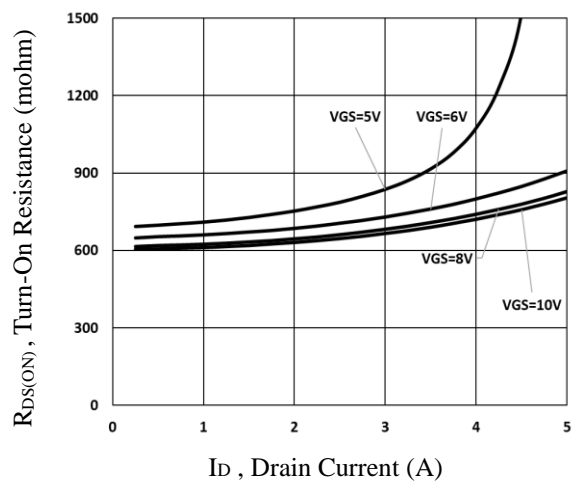

Fig.6 Turn-On Resistance vs. I_D

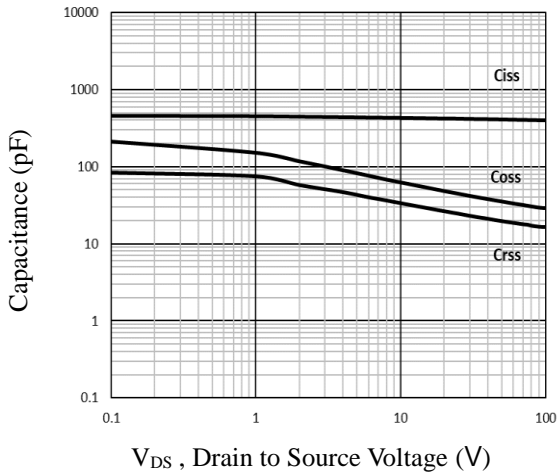

Fig.7 Capacitance Characteristics

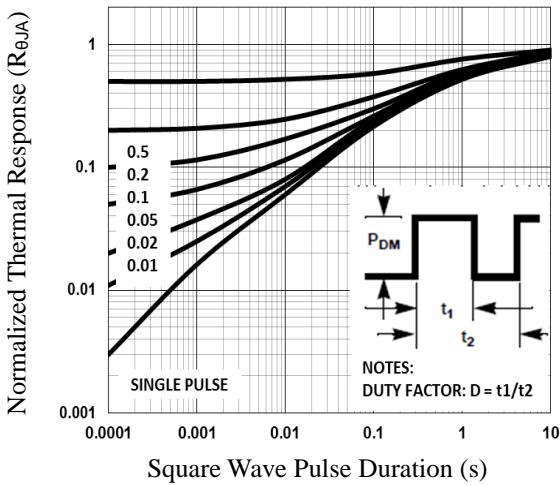

Fig.8 Normalized Transient Impedance

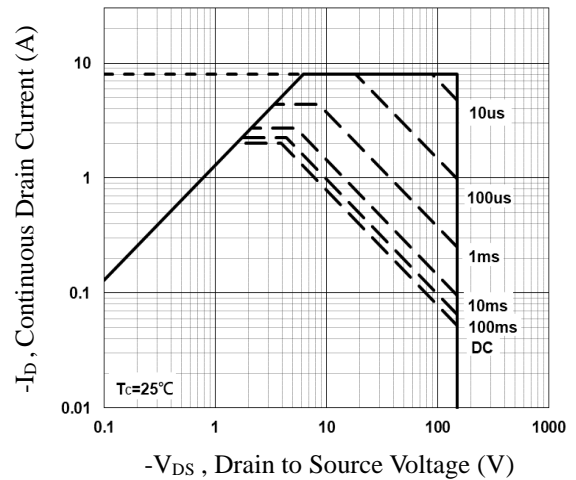

Fig.9 Maximum Safe Operation Area

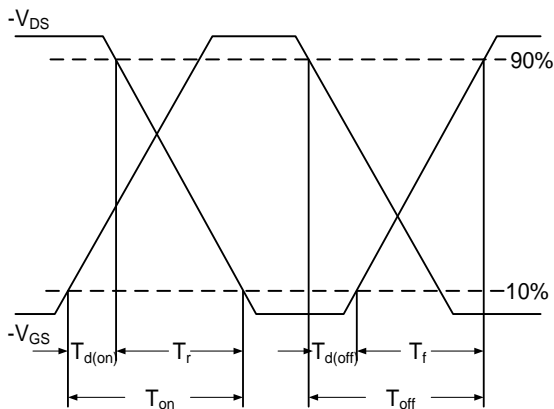

Fig.10 Switching Time Waveform

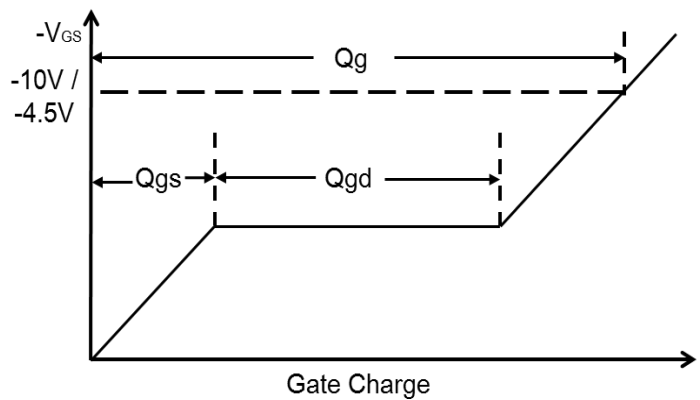
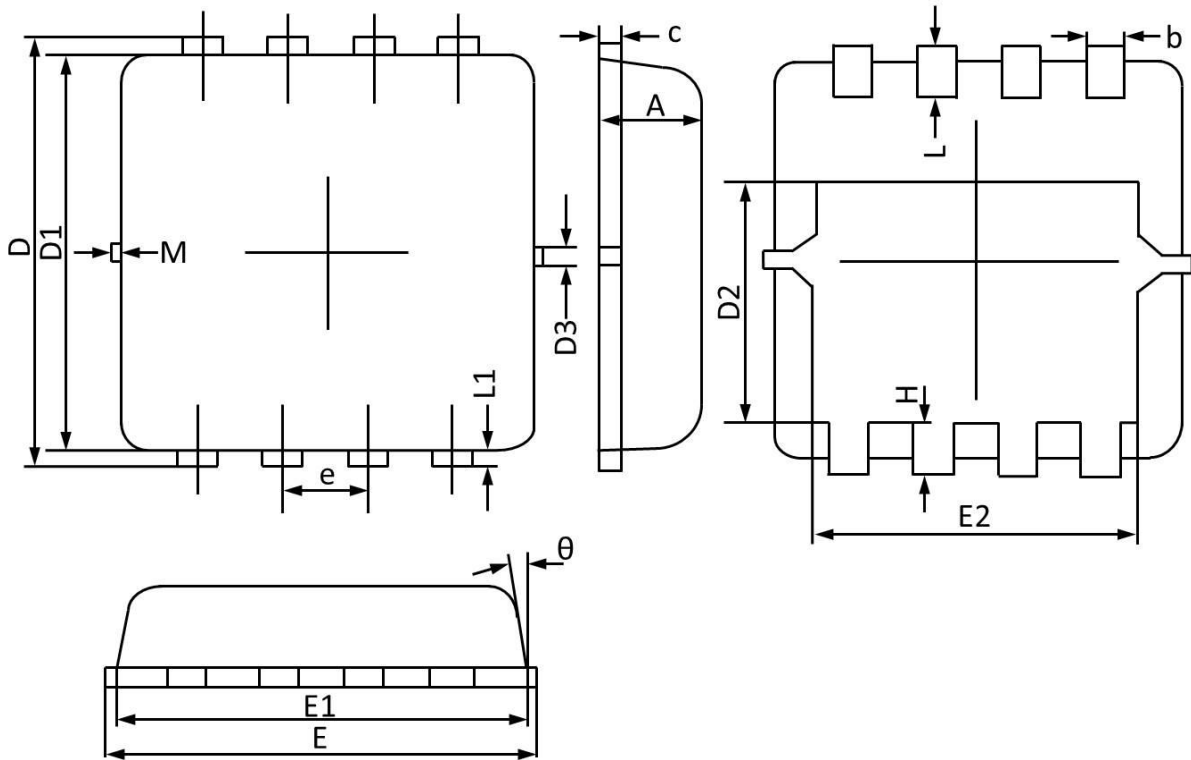

Fig.11 Gate Charge Waveform

PPAK3X3 PACKAGE INFORMATION



| Symbol | Dimensions In Millimeters | | Dimensions In Inches | |
|--------|---------------------------|-------|----------------------|-------|
| | Min | Max | Min | Max |
| A | 0.700 | 0.800 | 0.028 | 0.031 |
| b | 0.250 | 0.350 | 0.010 | 0.013 |
| c | 0.100 | 0.250 | 0.004 | 0.009 |
| D | 3.250 | 3.450 | 0.128 | 0.135 |
| D1 | 3.000 | 3.200 | 0.119 | 0.125 |
| D2 | 1.780 | 1.980 | 0.070 | 0.077 |
| D3 | 0.130 REF | | 0.005 REF | |
| E | 3.200 | 3.400 | 0.126 | 0.133 |
| E1 | 3.000 | 3.200 | 0.119 | 0.125 |
| E2 | 2.390 | 2.590 | 0.094 | 0.102 |
| e | 0.650 BSC | | 0.026 BSC | |
| H | 0.300 | 0.500 | 0.011 | 0.019 |
| L | 0.300 | 0.500 | 0.011 | 0.019 |
| L1 | 0.130 REF | | 0.005 REF | |
| θ | 0° | 12° | 0° | 12° |
| M | 0.150 REF | | 0.006 REF | |