

General Description

These N-Channel enhancement mode power field effect transistors are using trench DMOS technology. This advanced technology has been especially tailored to minimize on-state resistance, provide superior switching performance, and withstand high energy pulse in the avalanche and commutation mode. These devices are well suited for high efficiency fast switching applications.

BVDSS	RDSON	ID
600V	65mΩ	60A

Features

- 600V,60A, $R_{DS(ON)} = 65m\Omega @ V_{GS} = 10V$
- Improved dv/dt capability
- Fast switching
- 100% EAS Guaranteed
- Green Device Available

TO247 Pin Configuration

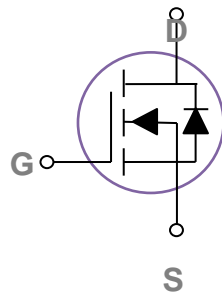

Applications

- High efficient switched mode power supplies
- LED Lighting
- Adapter/charger

Absolute Maximum Ratings $T_c=25^\circ C$ unless otherwise noted

Symbol	Parameter	Rating	Units
V_{DS}	Drain-Source Voltage	600	V
V_{GS}	Gate-Source Voltage	± 30	V
I_D	Drain Current – Continuous ($T_c=25^\circ C$)	60	A
	Drain Current – Continuous ($T_c=100^\circ C$)	38	A
I_{DM}	Drain Current – Pulsed ¹	240	A
EAS	Single Pulse Avalanche Energy ²	1800	mJ
IAS	Single Pulse Avalanche Current ²	10	A
P_D	Power Dissipation ($T_c=25^\circ C$)	312	W
	Power Dissipation – Derate above $25^\circ C$	2.5	W/ $^\circ C$
T_{STG}	Storage Temperature Range	-50 to 150	$^\circ C$
T_J	Operating Junction Temperature Range	-50 to 150	$^\circ C$

Thermal Characteristics

Symbol	Parameter	Typ.	Max.	Unit
$R_{\theta JA}$	Thermal Resistance Junction to ambient	---	40	$^\circ C/W$
$R_{\theta JC}$	Thermal Resistance Junction to Case	---	0.4	$^\circ C/W$

Electrical Characteristics (T_J=25 °C, unless otherwise noted)
Off Characteristics

Symbol	Parameter	Conditions	Min.	Typ.	Max.	Unit
BV _{DSS}	Drain-Source Breakdown Voltage	V _{GS} =0V, I _D =250uA	600	---	---	V
I _{DSS}	Drain-Source Leakage Current	V _{DS} =600V, V _{GS} =0V, T _J =25°C	---	---	50	uA
I _{GSS}	Gate-Source Leakage Current	V _{GS} =±30V, V _{DS} =0V	---	---	±100	nA

On Characteristics

R _{DS(ON)}	Static Drain-Source On-Resistance	V _{GS} =10V, I _D =20A	---	---	65	mΩ
V _{GS(th)}	Gate Threshold Voltage	V _{GS} =V _{DS} , I _D =250uA	2.5	---	4.5	V

Dynamic and switching Characteristics

Q _g	Total Gate Charge ^{3, 4}	V _{DS} =50V, V _{GS} =10V, I _D =1.3A	---	160	---	nC
Q _{gs}	Gate-Source Charge ^{3, 4}		---	25	---	
Q _{gd}	Gate-Drain Charge ^{3, 4}		---	65	---	
T _{d(on)}	Turn-On Delay Time ^{3, 4}	V _{DD} =30V, V _{GS} =10V, R _G =25Ω I _D =0.5A	---	150	---	ns
T _r	Rise Time ^{3, 4}		---	500	---	
T _{d(off)}	Turn-Off Delay Time ^{3, 4}		---	1400	---	
T _f	Fall Time ^{3, 4}		---	823	---	
C _{iss}	Input Capacitance	V _{DS} =25V, V _{GS} =0V, F=1MHz	---	4900	---	pF
C _{oss}	Output Capacitance		---	2730	---	
C _{rss}	Reverse Transfer Capacitance		---	128	---	

Drain-Source Diode Characteristics and Maximum Ratings

Symbol	Parameter	Conditions	Min.	Typ.	Max.	Unit
I _S	Continuous Source Current	V _G =V _D =0V, Force Current	---	---	60	A
I _{SM}	Pulsed Source Current		---	---	120	A
V _{SD}	Diode Forward Voltage	V _{GS} =0V, I _S =60A, T _J =25°C	---	---	1.4	V
T _{rr}	Body Diode Reverse Recovery Time	I _S =30A, V _{GS} =0V, V _R =200V	---	640	---	nS
Q _{rr}	Body Diode Reverse Recovery Charge	dI _F /dt=100A/uS	---	14	---	uC

Note :

1. Repetitive Rating : Pulsed width limited by maximum junction temperature.
2. V_{DD}=50V, V_{GS}=10V, L=36mH, I_{AS}=10A, R_G=25Ω, Starting T_J=25°C.
3. The data tested by pulsed, pulse width ≤ 300us, duty cycle ≤ 2%.
4. Essentially independent of operating temperature.

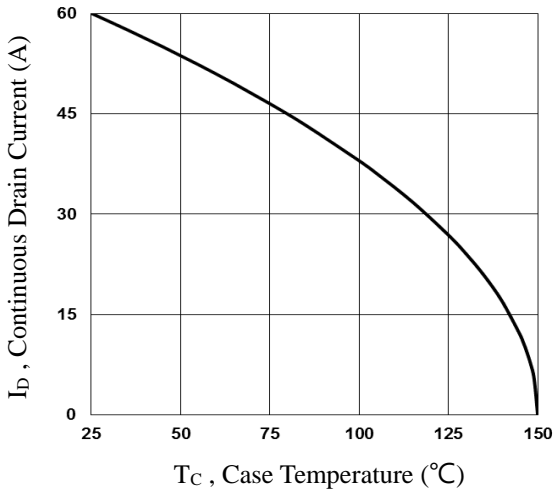

Fig.1 Continuous Drain Current vs. T_c

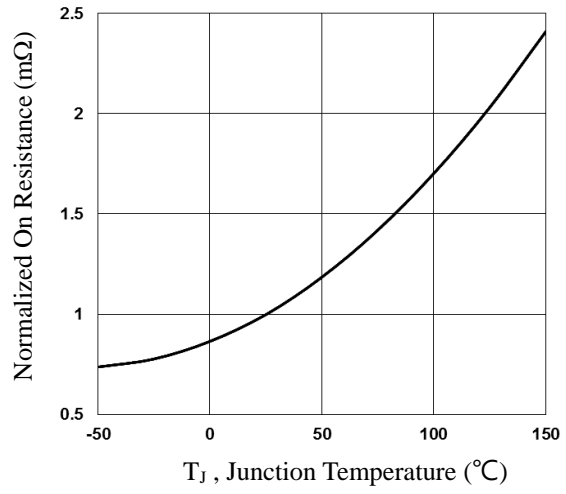

Fig.2 Normalized RDSON vs. T_j

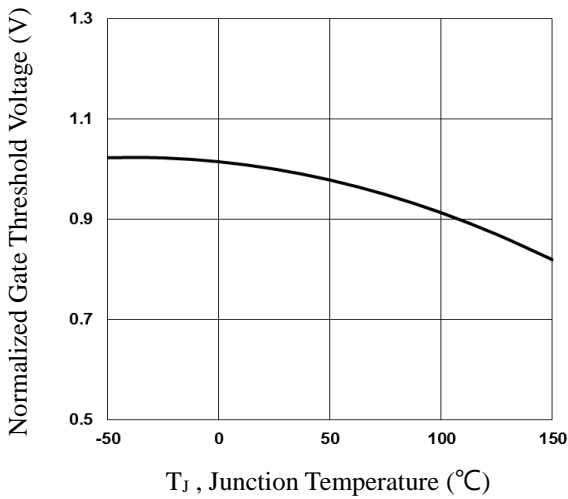

Fig.3 Normalized V_{th} vs. T_j

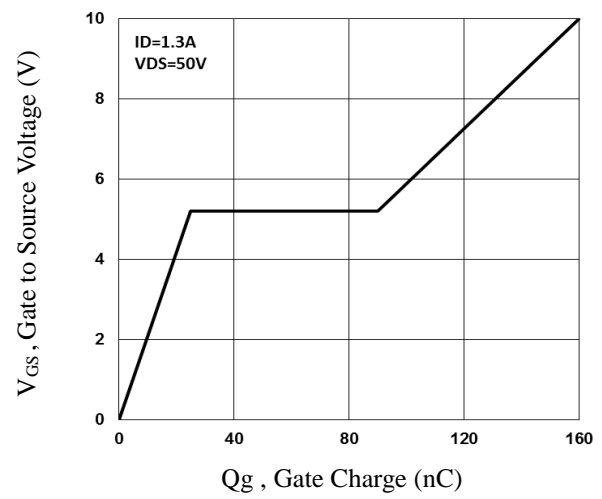

Fig.4 Gate Charge Characteristics

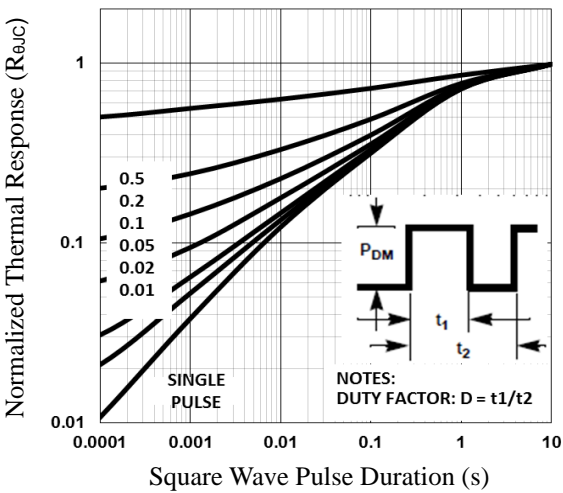

Fig.5 Normalized Transient Impedance

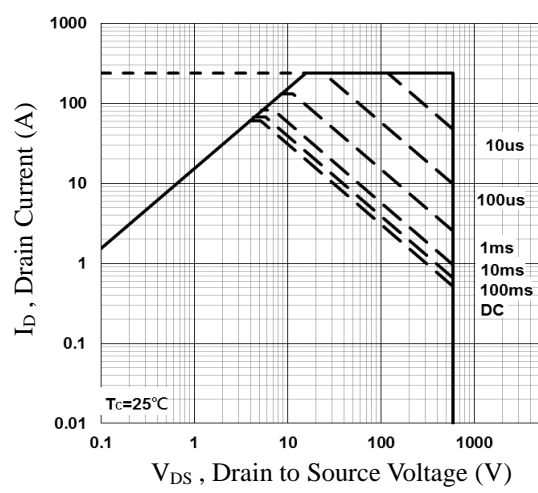

Fig.6 Maximum Safe Operation Area



Fig.7 Switching Time Waveform

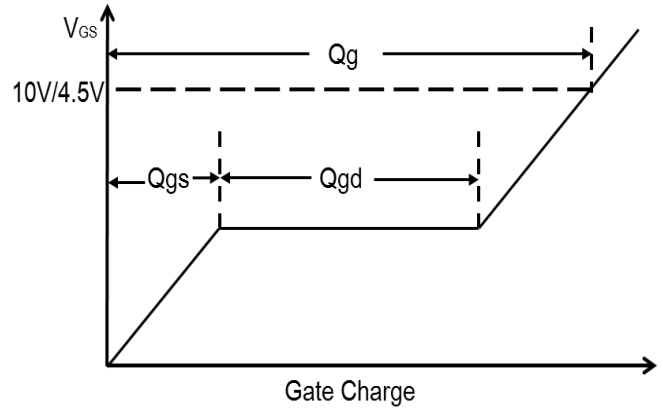
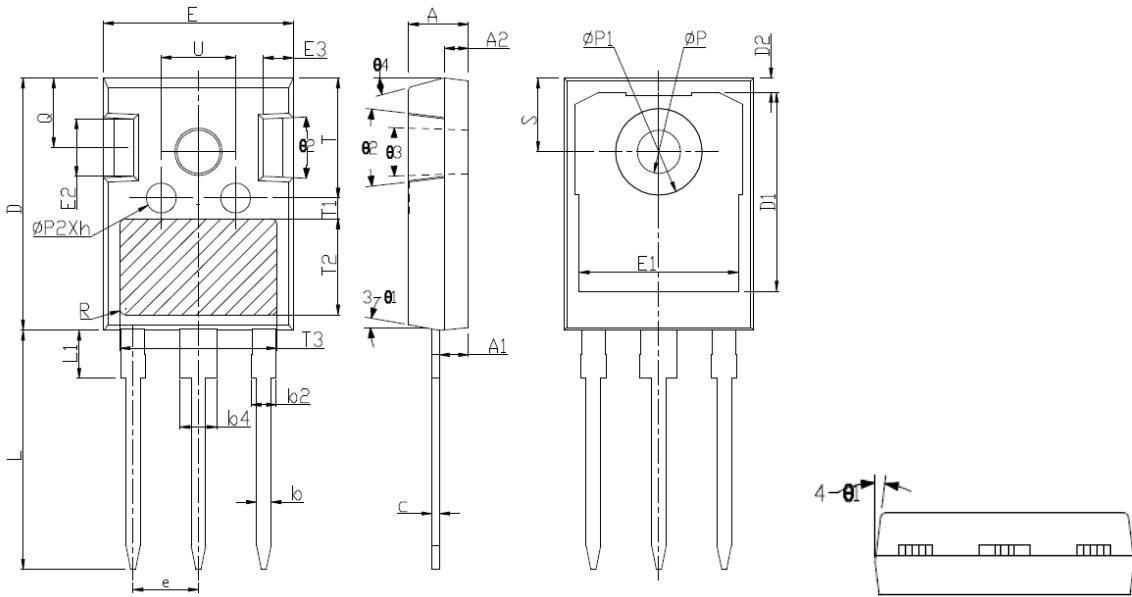

Fig.8 Gate Charge Waveform

TO247 PACKAGE INFORMATION



SYMBOL	mm			SYMBOL	mm		
	MIN	NOM	MAX		MIN	NOM	MAX
A	4.75	5.00	5.25	L	19.52	19.92	20.32
A1	2.16	2.41	2.66	L1	---	---	4.30
A2	1.85	2.00	2.15	ΦP	3.35	3.60	3.85
b	1.11	1.20	1.35	ΦP1	---	---	7.30
b2	1.90	2.01	2.25	ΦP2	2.25	2.50	2.75
b4	2.90	3.10	3.25	Q	5.50	5.80	6.10
c	0.51	0.61	0.75	S	6.15BSC		
D	20.60	21.00	21.40	R	0.50REF		
D1	16.15	16.55	16.95	T	9.70	---	10.30
D2	1.00	1.20	1.40	T1	1.65REF		
E	15.50	15.80	16.10	T2	8.00REF		
E1	13.00	13.30	13.60	T3	12.80REF		
E2	4.70	5.00	5.30	U	5.9	---	6.5
E3	2.25	2.50	2.75	θ1	4°	7°	10°
e	5.44BSC			θ2	2°	5°	8°
h	0.00	0.10	0.25	θ3	1°	---	2°
				θ4	10°	15°	20°