

General Description

These N-Channel enhancement mode power field effect transistors are using Super Junction technology. This advanced technology has been especially tailored to minimize on-state resistance, provide superior switching performance, and withstand high energy pulse in the avalanche and commutation mode. These devices are well suited for high efficiency switch mode power supply

BVDSS	RDSON	ID
650V	69mΩ	53A

Features

- 53A,650V, $R_{DS(ON)} = 69m\Omega @ V_{GS} = 10V$
- Improved dv/dt capability
- Fast switching
- 100% EAS Guaranteed
- Green Device Available

TO247 Pin Configuration

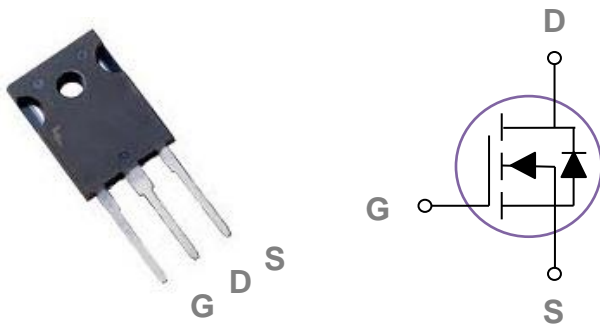

Applications

- High efficient switched mode power supplies
- LED Lighting
- Adapter/charger

Absolute Maximum Ratings (Tc=25°C unless otherwise noted)

Symbol	Parameter	Rating	Units
V _{DS}	Drain-Source Voltage	650	V
V _{GS}	Gate-Source Voltage	±30	V
I _D	Drain Current – Continuous (T _C =25°C)	53	A
	Drain Current – Continuous (T _C =100°C)	33.5	A
I _{DM}	Drain Current – Pulsed ¹	212	A
EAS	Single Pulse Avalanche Energy ²	344	mJ
IAS	Single Pulse Avalanche Current ²	8.3	A
P _D	Power Dissipation (T _C =25°C)	390	W
	Power Dissipation – Derate above 25°C	3.125	W/°C
T _{STG}	Storage Temperature Range	-55 to 150	°C
T _J	Operating Junction Temperature Range	-55 to 150	°C

Thermal Characteristics

Symbol	Parameter	Typ.	Max.	Unit
R _{θJA}	Thermal Resistance Junction to ambient	---	62	°C/W
R _{θJC}	Thermal Resistance Junction to Case	---	0.32	°C/W

Electrical Characteristics (T_J=25 °C, unless otherwise noted)
Off Characteristics

Symbol	Parameter	Conditions	Min.	Typ.	Max.	Unit
BV _{DSS}	Drain-Source Breakdown Voltage	V _{GS} =0V, I _D =1mA	650	---	---	V
ΔBV _{DSS} /ΔT _J	BV _{DSS} Temperature Coefficient	Reference to 25°C, I _D =1mA	---	0.48	---	V/°C
I _{DSS}	Drain-Source Leakage Current	V _{DS} =650V, V _{GS} =0V, T _J =25°C	---	---	10	μA
I _{GSS}	Gate-Source Leakage Current	V _{GS} =±30V, V _{DS} =0V	---	---	±100	nA

On Characteristics

R _{DS(ON)}	Static Drain-Source On-Resistance	V _{GS} =10V, I _D =26.5A	---	55	69	mΩ
V _{GS(th)}	Gate Threshold Voltage	V _{GS} =V _{DS} , I _D =1mA	2	---	4	V
ΔV _{GS(th)}	V _{GS(th)} Temperature Coefficient		---	-8.83	---	mV/°C

Dynamic and switching Characteristics

Q _g	Total Gate Charge ^{2, 3}	V _{DS} =400V, V _{GS} =10V, I _D =30A	---	60.2	---	nC
Q _{gs}	Gate-Source Charge ^{2, 3}		---	24.5	---	
Q _{gd}	Gate-Drain Charge ^{2, 3}		---	18.7	---	
T _{d(on)}	Turn-On Delay Time ^{2, 3}	V _{DD} =400V, V _{GS} =10V, R _G =25Ω I _D =30A	---	129	---	ns
T _r	Rise Time ^{2, 3}		---	150	---	
T _{d(off)}	Turn-Off Delay Time ^{2, 3}		---	100	---	
T _f	Fall Time ^{2, 3}		---	77	---	
C _{iss}	Input Capacitance	V _{DS} =50V, V _{GS} =0V, F=100KHz	---	4650	---	pF
C _{oss}	Output Capacitance		---	280	---	
C _{rss}	Reverse Transfer Capacitance		---	8.6	---	

Drain-Source Diode Characteristics and Maximum Ratings

Symbol	Parameter	Conditions	Min.	Typ.	Max.	Unit
I _S	Continuous Source Current	V _G =V _D =0V, Force Current	---	---	53	A
I _{SM}	Pulsed Source Current		---	---	106	A
V _{SD}	Diode Forward Voltage	V _{GS} =0V, I _S =53A, T _J =25°C	---	---	1.4	V
t _{rr}	Reverse Recovery Time ²	V _{GS} =0V, I _S =30A, dI/dt=100A/μs, T _J =25°C	---	174	---	ns
Q _{rr}	Reverse Recovery Charge ²		---	1.05	---	μC
I _{rrm}	Peak reverse recovery current		---	11.32	---	A

Note :

1. Repetitive Rating : Pulsed width limited by maximum junction temperature.
2. V_{DD}=100V, V_{GS}=10V, L=10mH, I_{AS}=8.3A., R_G=25Ω, Starting T_J=25°C.
3. The data tested by pulsed, pulse width ≤ 300us, duty cycle ≤ 2%.
4. Essentially independent of operating temperature.

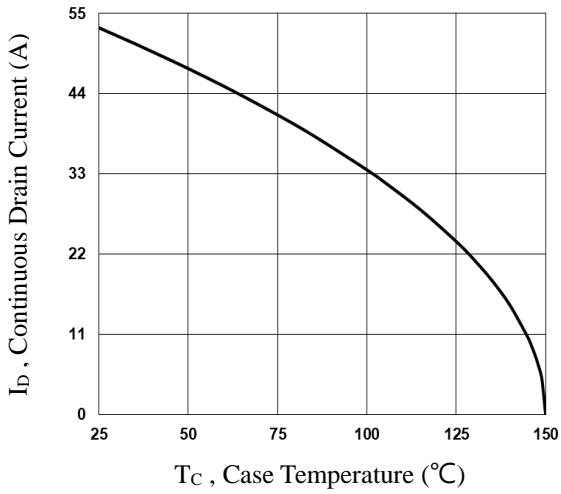

Fig.1 Continuous Drain Current vs. T_c

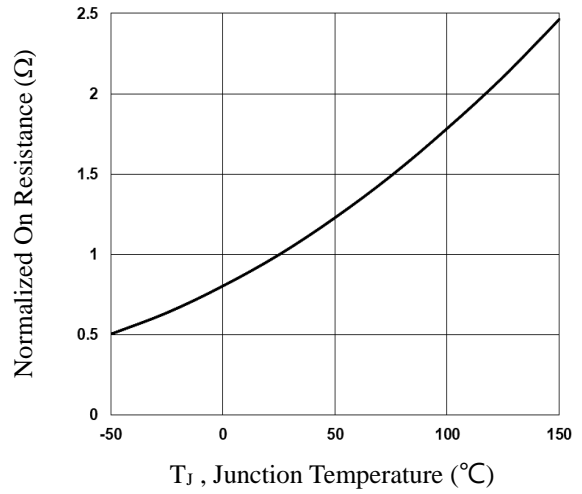

Fig.2 Normalized RDS(on) vs. T_J

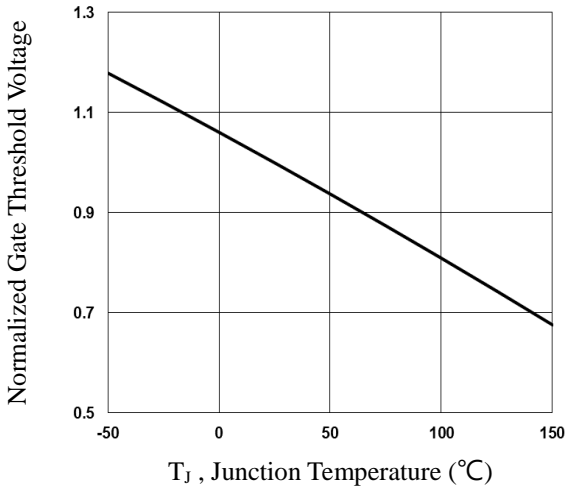

Fig.3 Normalized V_{th} vs. T_J

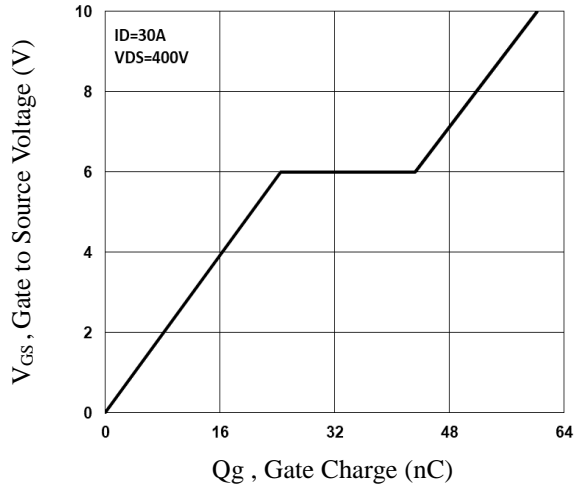

Fig.4 Gate Charge Waveform

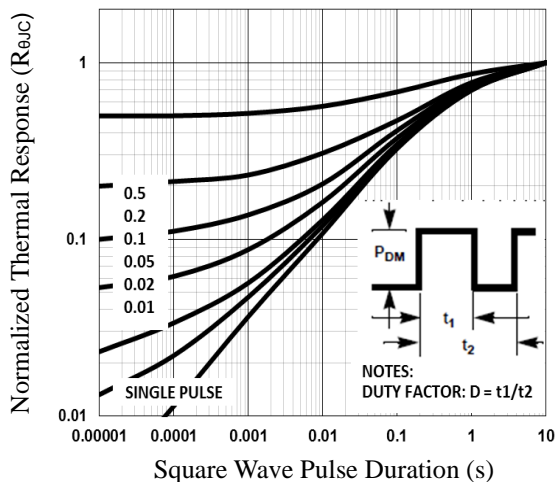

Fig.5 Normalized Transient Impedance

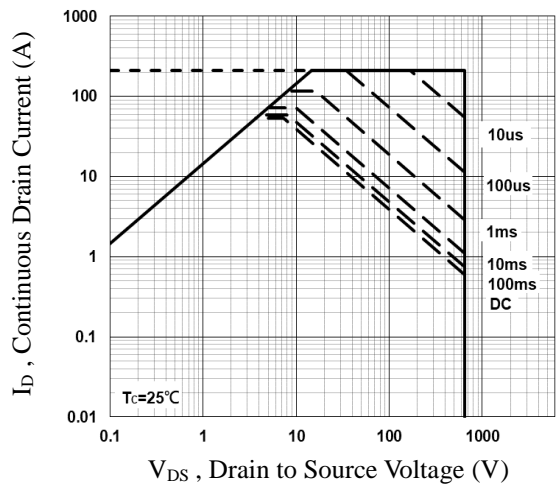

Fig.6 Maximum Safe Operation Area

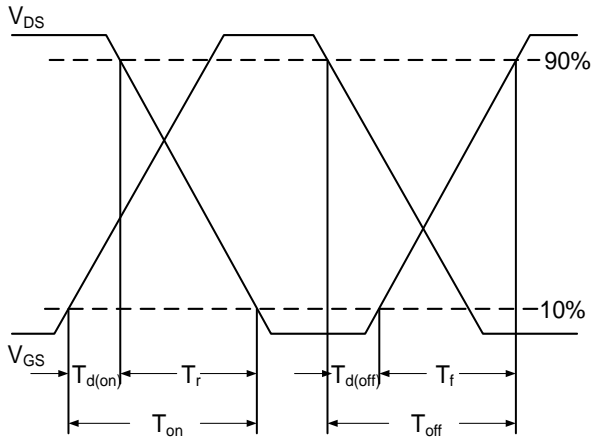

Fig.7 Switching Time Waveform

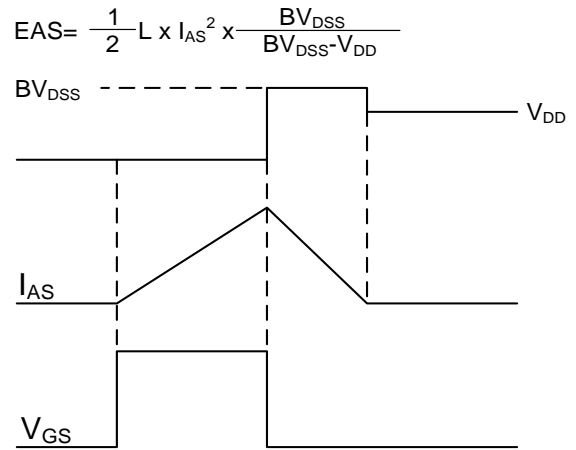
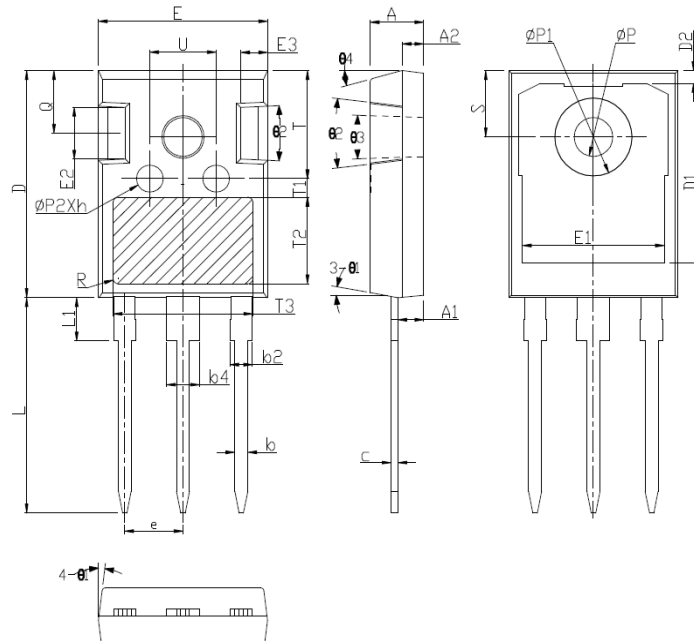

Fig.8 EAS Waveform

$$EAS = \frac{1}{2} L \times I_{AS}^2 \times \frac{BV_{DSS}}{BV_{DSS} - V_{DD}}$$

TO247 PACKAGE INFORMATION



Symbol	Dimensions In Millimeters			Symbol	Dimensions In Millimeters		
	Min	Nom	Max		Min	Nom	Max
A	4.750	5.000	5.250	L	19.520	19.920	20.320
A1	2.160	2.410	2.660	L1	---	---	4.300
A2	1.850	2.000	2.150	ΦP	3.350	3.600	3.850
b	1.110	1.200	1.350	ΦP1	---	---	7.300
b2	1.900	2.010	2.250	ΦP2	2.250	2.500	2.750
b4	2.900	3.100	3.250	Q	5.500	5.800	6.100
c	0.510	0.610	0.750	S	6.15BSC		
D	20.600	21.000	21.400	R	0.50REF		
D1	16.150	16.550	16.950	T	9.700	---	10.300
D2	1.000	1.200	1.400	T1	1.65REF		
E	15.500	15.800	16.100	T2	8.00REF		
E1	13.000	13.300	13.600	T3	12.80REF		
E2	4.700	5.000	5.300	U	5.900	---	6.500
E3	2.250	2.500	2.750	θ1	3°	7°	10°
e	5.44BSC			θ2	2°	5°	8°
h	0.000	0.100	0.250	θ3	1°	---	2°
				θ4	10°	15°	20°