

General Description

These N-Channel enhancement mode power field effect transistors are using Super Junction technology. This advanced technology has been especially tailored to minimize on-state resistance, provide superior switching performance, and withstand high energy pulse in the avalanche and commutation mode. These devices are well suited for high efficiency switch mode power supply

BVDSS	RDSON	ID
650V	0.57Ω	7A

Features

- 7A,650V, $R_{DS(ON)} = 0.57\Omega @ V_{GS} = 10V$
- Improved dv/dt capability
- Fast switching
- 100% EAS Guaranteed
- Green Device Available

TO251 Pin Configuration



Applications

- High efficient switched mode power supplies
- LED Lighting
- Adapter/charger

Absolute Maximum Ratings (Tc=25°C unless otherwise noted)

Symbol	Parameter	Rating	Units
V _{DS}	Drain-Source Voltage	650	V
V _{GS}	Gate-Source Voltage	±30	V
I _D	Drain Current – Continuous (T _C =25°C)	7	A
	Drain Current – Continuous (T _C =100°C)	4.4	A
I _{DM}	Drain Current – Pulsed ¹	28	A
E _{AS}	Single Pulse Avalanche Energy ²	120	mJ
I _{AR}	Repetitive Avalanche Current ¹	4.9	A
P _D	Power Dissipation (T _C =25°C)	50	W
	Power Dissipation – Derate above 25°C	0.4	W/°C
T _{STG}	Storage Temperature Range	-55 to 150	°C
T _J	Operating Junction Temperature Range	-55 to 150	°C

Thermal Characteristics

Symbol	Parameter	Typ.	Max.	Unit
R _{θJA}	Thermal Resistance Junction to ambient	---	80	°C/W
R _{θJC}	Thermal Resistance Junction to Case	---	2.5	°C/W

Electrical Characteristics (T_J=25 °C, unless otherwise noted)
Off Characteristics

Symbol	Parameter	Conditions	Min.	Typ.	Max.	Unit
BV _{DSS}	Drain-Source Breakdown Voltage	V _{GS} =0V, I _D =250uA	650	---	---	V
ΔBV _{DSS} /ΔT _J	BV _{DSS} Temperature Coefficient	Reference to 25°C, I _D =1mA	---	0.59	---	V/°C
I _{DSS}	Drain-Source Leakage Current	V _{DS} =650V, V _{GS} =0V, T _J =25°C	---	---	1	uA
		V _{DS} =650V, V _{GS} =0V, T _J =125°C	---	10	---	uA
I _{GSS}	Gate-Source Leakage Current	V _{GS} =±30V, V _{DS} =0V	---	---	±100	nA

On Characteristics

R _{DS(ON)}	Static Drain-Source On-Resistance	V _{GS} =10V, I _D =3.5A, T _J =25°C	---	0.47	0.57	Ω
		V _{GS} =10V, I _D =3.5A, T _J =150°C	---	1.9	---	
V _{GS(th)}	Gate Threshold Voltage	V _{GS} =V _{DS} , I _D =250uA	2.5	3.5	4.5	V
ΔV _{GS(th)}	V _{GS(th)} Temperature Coefficient		---	-9.3	---	mV/°C

Dynamic and switching Characteristics

Q _g	Total Gate Charge ^{3,4}	V _{DS} =480V, V _{GS} =10V, I _D =3.5A	---	15	---	nC
Q _{gs}	Gate-Source Charge ^{3,4}		---	2.4	---	
Q _{gd}	Gate-Drain Charge ^{3,4}		---	6.8	---	
T _{d(on)}	Turn-On Delay Time ^{3,4}	V _{DD} =300V, V _{GS} =10V, R _G =12Ω I _D =3.5A	---	11	---	ns
T _r	Rise Time ^{3,4}		---	10	---	
T _{d(off)}	Turn-Off Delay Time ^{3,4}		---	30	---	
T _f	Fall Time ^{3,4}		---	6	---	
C _{iss}	Input Capacitance	V _{DS} =25V, V _{GS} =0V, F=1MHz	---	604	---	pF
C _{oss}	Output Capacitance		---	278	---	
C _{rss}	Reverse Transfer Capacitance		---	0.6	---	

Drain-Source Diode Characteristics and Maximum Ratings

Symbol	Parameter	Conditions	Min.	Typ.	Max.	Unit
I _S	Continuous Source Current	V _G =V _D =0V, Force Current	---	---	7	A
I _{SM}	Pulsed Source Current		---	---	14	A
V _{SD}	Diode Forward Voltage	V _{GS} =0V, I _S =3.5A, T _J =25°C	---	---	1.2	V
t _{rr}	Reverse Recovery Time ³	I _S =7A, dI/dt=100A/μs, T _J =25°C	---	262	---	ns
Q _{rr}	Reverse Recovery Charge ³		---	3.5	---	uC
I _{rrm}	Peak reverse recovery current		---	15	---	A

Note :

1. Repetitive Rating : Pulsed width limited by maximum junction temperature.
2. V_{DD}=60V, I_{AS}=4.9A., L=10mH, R_G=25Ω, Starting T_J=25°C.
3. The data tested by pulsed, pulse width ≤ 300us, duty cycle ≤ 2%.
4. Essentially independent of operating temperature.

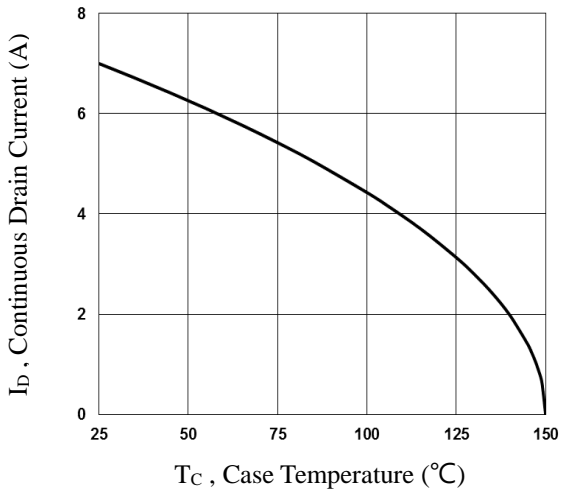

Fig.1 Continuous Drain Current vs. T_c

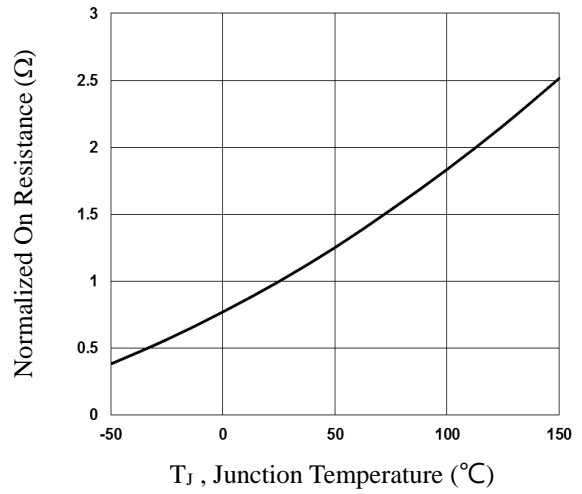

Fig.2 Normalized $R_{DS(on)}$ vs. T_j

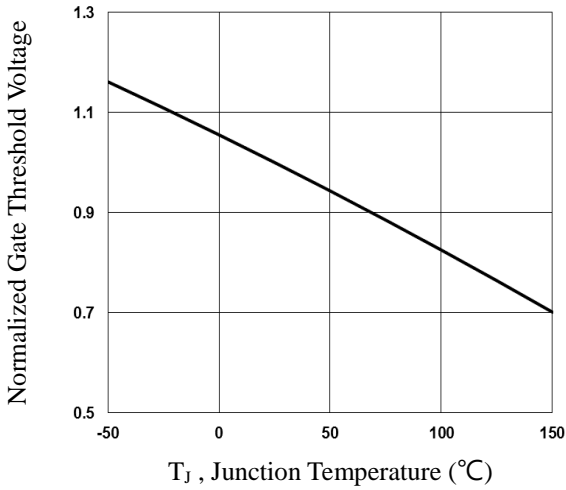

Fig.3 Normalized V_{th} vs. T_j

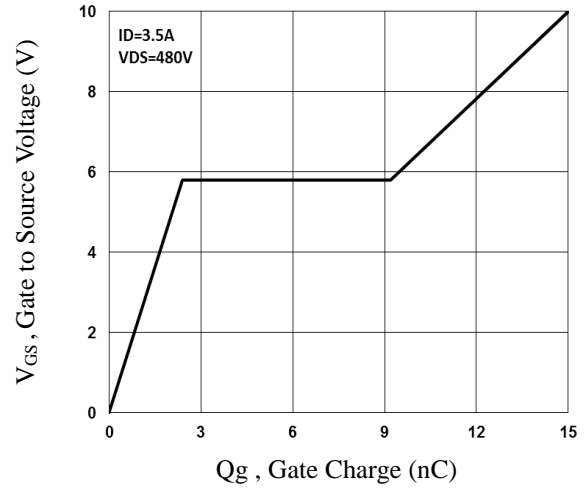

Fig.4 Gate Charge Waveform

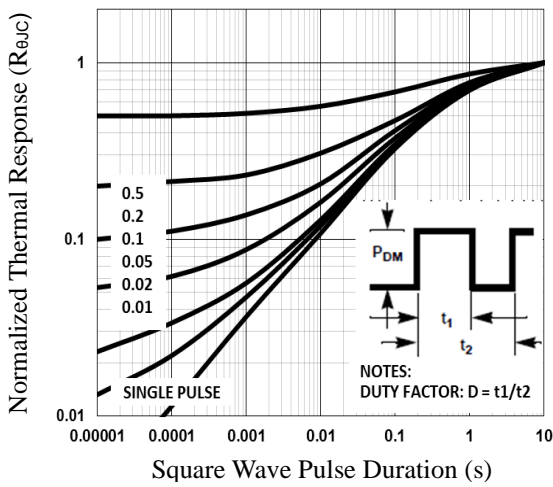

Fig.5 Normalized Transient Impedance

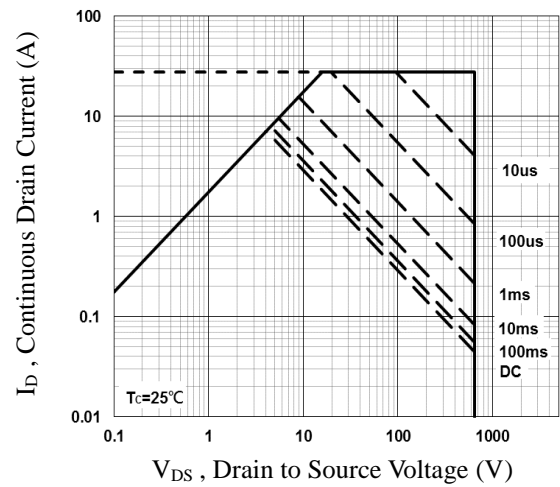

Fig.6 Maximum Safe Operation Area



Fig.7 Switching Time Waveform

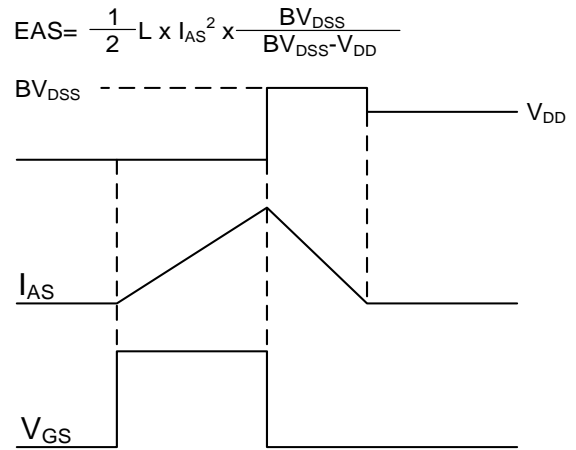
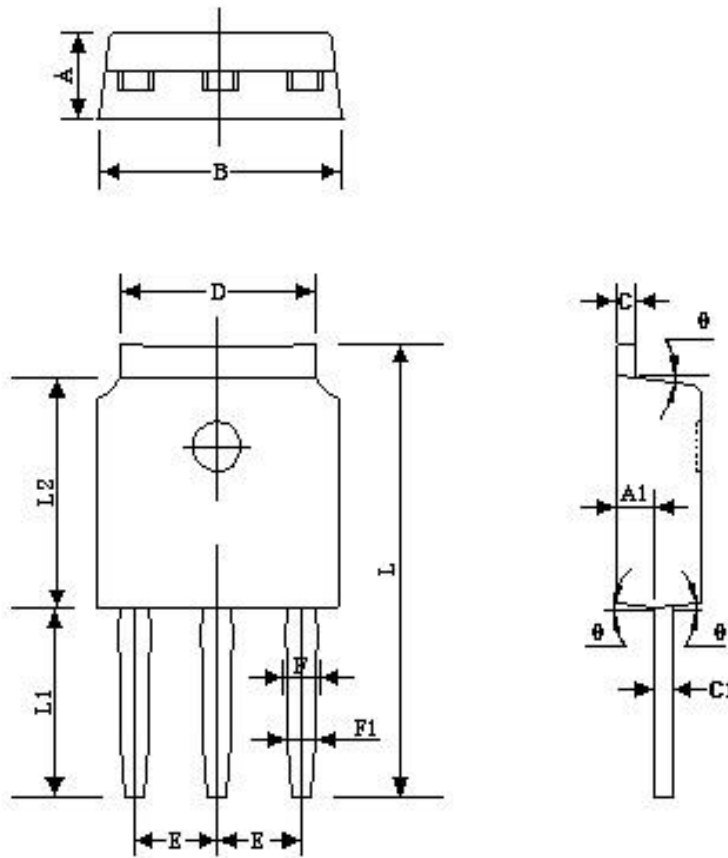

Fig.8 EAS Waveform

TO251 PACKAGE INFORMATION



Symbol	Dimensions In Millimeters		Dimensions In Inches	
	MAX	MIN	MAX	MIN
A	2.400	2.200	0.094	0.087
A1	1.110	0.910	0.044	0.036
B	6.700	6.500	0.264	0.256
C	0.580	0.460	0.023	0.018
C1	0.580	0.460	0.023	0.018
D	5.460	5.100	0.215	0.201
E	2.386	2.186	0.094	0.086
F	0.940	0.740	0.037	0.029
F1	0.860	0.660	0.034	0.026
L	12.300	11.700	0.484	0.461
L1	5.200	4.800	0.205	0.189
L2	6.200	6.000	0.244	0.236
θ	9°	3°	9°	3°