

### General Description

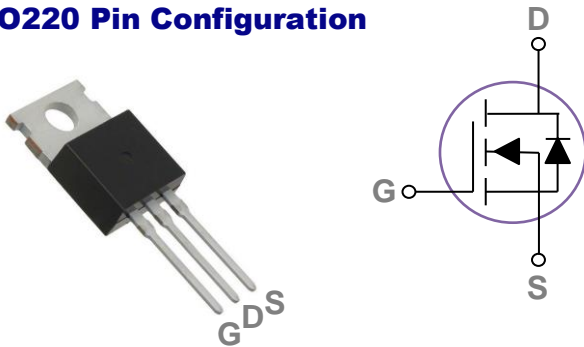
These N-Channel enhancement mode power field effect transistors are using Super Junction technology. This advanced technology has been especially tailored to minimize on-state resistance, provide superior switching performance, and withstand high energy pulse in the avalanche and commutation mode. These devices are well suited for high efficiency switch mode power supply

BVDSS	RDSON	ID
650V	0.29Ω	15A

### Features

- 15A,650V,  $R_{DS(ON)} = 0.29\Omega @ V_{GS} = 10V$
- Improved dv/dt capability
- Fast switching
- 100% EAS Guaranteed
- Green Device Available

### TO220 Pin Configuration



### Applications

- High efficient switched mode power supplies
- LED Lighting
- Adapter/charger

### Absolute Maximum Ratings (Tc=25°C unless otherwise noted)

Symbol	Parameter	Rating	Units
V <sub>DS</sub>	Drain-Source Voltage	650	V
V <sub>GS</sub>	Gate-Source Voltage	±30	V
I <sub>D</sub>	Drain Current – Continuous (T <sub>C</sub> =25°C)	15	A
	Drain Current – Continuous (T <sub>C</sub> =100°C)	9.5	A
I <sub>DM</sub>	Drain Current – Pulsed <sup>1</sup>	60	A
EAS	Single Pulse Avalanche Energy <sup>2</sup>	400	mJ
IAS	Single Pulse Avalanche Current <sup>2</sup>	6.3	A
P <sub>D</sub>	Power Dissipation (T <sub>C</sub> =25°C)	104	W
	Power Dissipation – Derate above 25°C	0.83	W/°C
T <sub>STG</sub>	Storage Temperature Range	-55 to 150	°C
T <sub>J</sub>	Operating Junction Temperature Range	-55 to 150	°C

### Thermal Characteristics

Symbol	Parameter	Typ.	Max.	Unit
R <sub>θJA</sub>	Thermal Resistance Junction to ambient	---	62.5	°C/W
R <sub>θJC</sub>	Thermal Resistance Junction to Case	---	1.2	°C/W

**Electrical Characteristics (T<sub>J</sub>=25 °C, unless otherwise noted)**
**Off Characteristics**

Symbol	Parameter	Conditions	Min.	Typ.	Max.	Unit
BV <sub>DSS</sub>	Drain-Source Breakdown Voltage	V <sub>GS</sub> =0V , I <sub>D</sub> =250uA	650	---	---	V
I <sub>DSS</sub>	Drain-Source Leakage Current	V <sub>DS</sub> =650V , V <sub>GS</sub> =0V , T <sub>J</sub> =25°C	---	---	1	uA
I <sub>GSS</sub>	Gate-Source Leakage Current	V <sub>GS</sub> =±30V , V <sub>DS</sub> =0V	---	---	±100	nA

**On Characteristics**

R <sub>DS(ON)</sub>	Static Drain-Source On-Resistance	V <sub>GS</sub> =10V , I <sub>D</sub> =7.5A	---	0.26	0.29	Ω
V <sub>GS(th)</sub>	Gate Threshold Voltage	V <sub>GS</sub> =V <sub>DS</sub> , I <sub>D</sub> =250uA	2	---	4	V

**Dynamic and switching Characteristics**

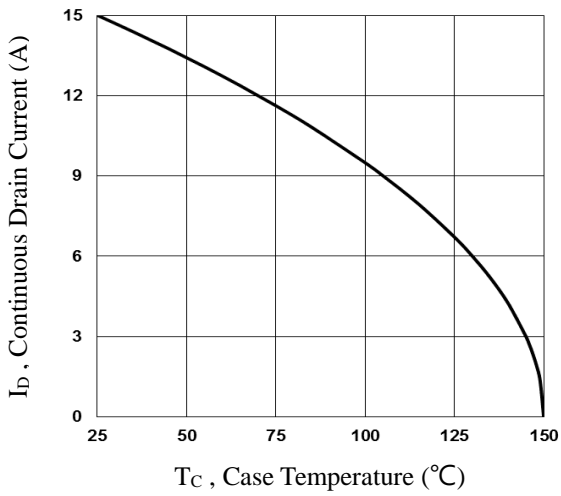
Q <sub>g</sub>	Total Gate Charge <sup>2, 3</sup>	V <sub>DS</sub> =520V , V <sub>GS</sub> =10V , I <sub>D</sub> =15A	---	18	---	nC
Q <sub>gs</sub>	Gate-Source Charge <sup>2, 3</sup>		---	5.9	---	
Q <sub>gd</sub>	Gate-Drain Charge <sup>2, 3</sup>		---	6	---	
T <sub>d(on)</sub>	Turn-On Delay Time <sup>2, 3</sup>	V <sub>DD</sub> =520V , V <sub>GS</sub> =10V , R <sub>G</sub> =25Ω I <sub>D</sub> =15A	---	30.9	---	ns
T <sub>r</sub>	Rise Time <sup>2, 3</sup>		---	39.9	---	
T <sub>d(off)</sub>	Turn-Off Delay Time <sup>2, 3</sup>		---	44.1	---	
T <sub>f</sub>	Fall Time <sup>2, 3</sup>		---	49.7	---	
C <sub>iss</sub>	Input Capacitance	V <sub>DS</sub> =50V , V <sub>GS</sub> =0V , F=1MHz	---	986	---	pF
C <sub>oss</sub>	Output Capacitance		---	67.7	---	
C <sub>rss</sub>	Reverse Transfer Capacitance		---	3.36	---	

**Drain-Source Diode Characteristics and Maximum Ratings**

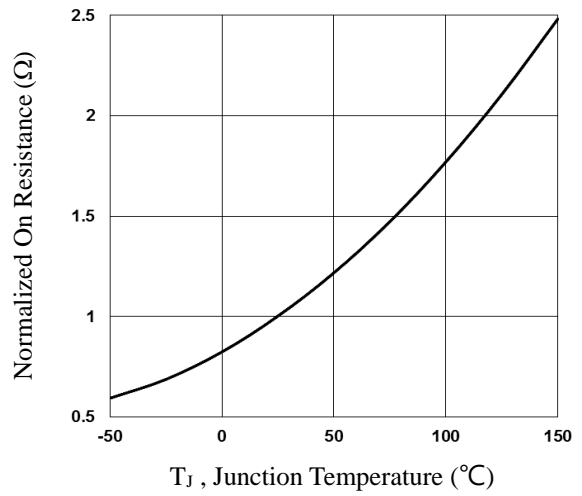
Symbol	Parameter	Conditions	Min.	Typ.	Max.	Unit
I <sub>S</sub>	Continuous Source Current	V <sub>G</sub> =V <sub>D</sub> =0V , Force Current	---	---	15	A
I <sub>SM</sub>	Pulsed Source Current		---	---	30	A
V <sub>SD</sub>	Diode Forward Voltage	V <sub>GS</sub> =0V , I <sub>S</sub> =15A , T <sub>J</sub> =25°C	---	---	1.4	V
t <sub>rr</sub>	Reverse Recovery Time <sup>2</sup>	V <sub>GS</sub> =0V, I <sub>S</sub> =15A , dI/dt=100A/μs , T <sub>J</sub> =25°C	---	352.9	---	ns
Q <sub>rr</sub>	Reverse Recovery Charge <sup>2</sup>		---	14.4	---	uC
I <sub>rrm</sub>	Peak reverse recovery current		---	23.1	---	A

Note :

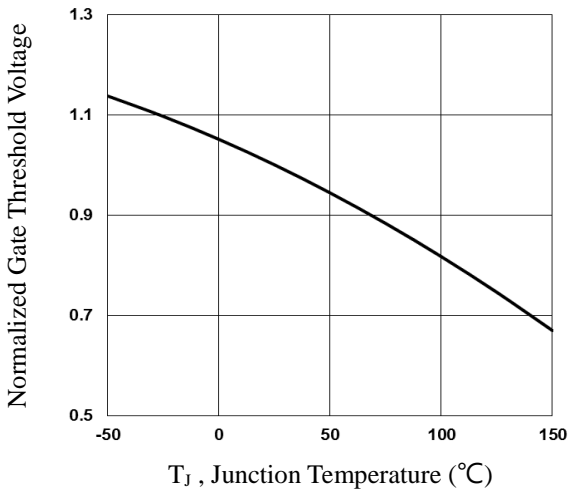
1. Repetitive Rating : Pulsed width limited by maximum junction temperature.
2. V<sub>DD</sub>=100V, V<sub>GS</sub>=10V, L=20mH, I<sub>AS</sub>=6.3A., R<sub>G</sub>=25Ω, Starting T<sub>J</sub>=25°C.
3. The data tested by pulsed , pulse width ≤ 300us , duty cycle ≤ 2%.
4. Essentially independent of operating temperature.



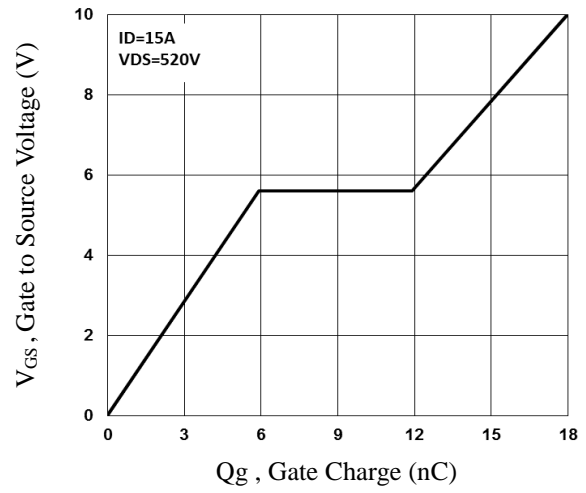
**Fig.1 Continuous Drain Current vs. Tc**



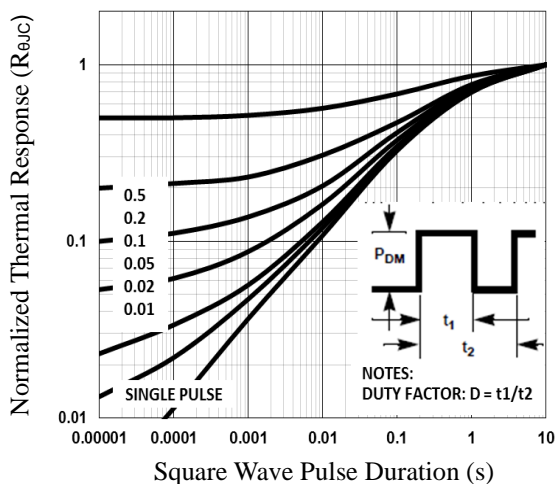
**Fig.2 Normalized RDSon vs. Tj**



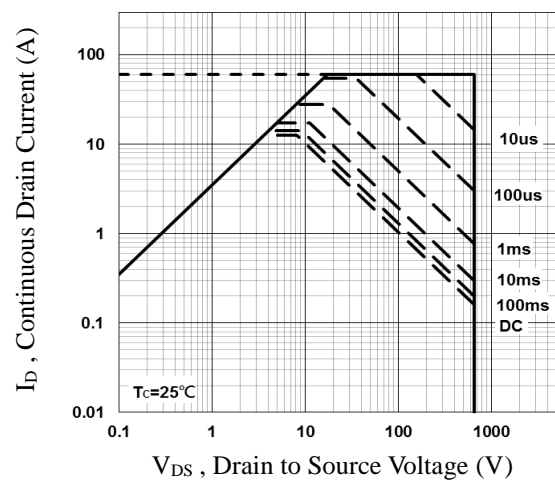
**Fig.3 Normalized Vth vs. Tj**



**Fig.4 Gate Charge Waveform**



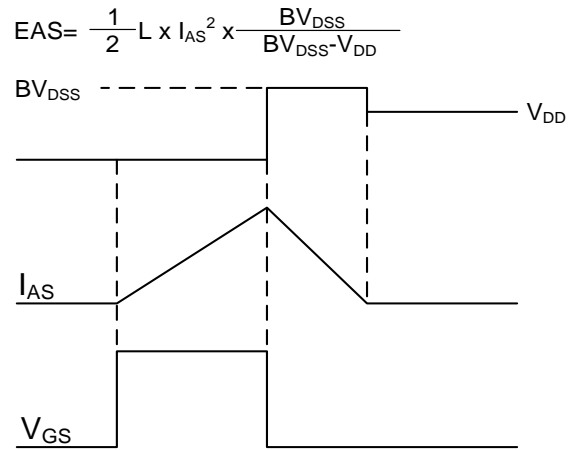
**Fig.5 Normalized Transient Impedance**



**Fig.6 Maximum Safe Operation Area**

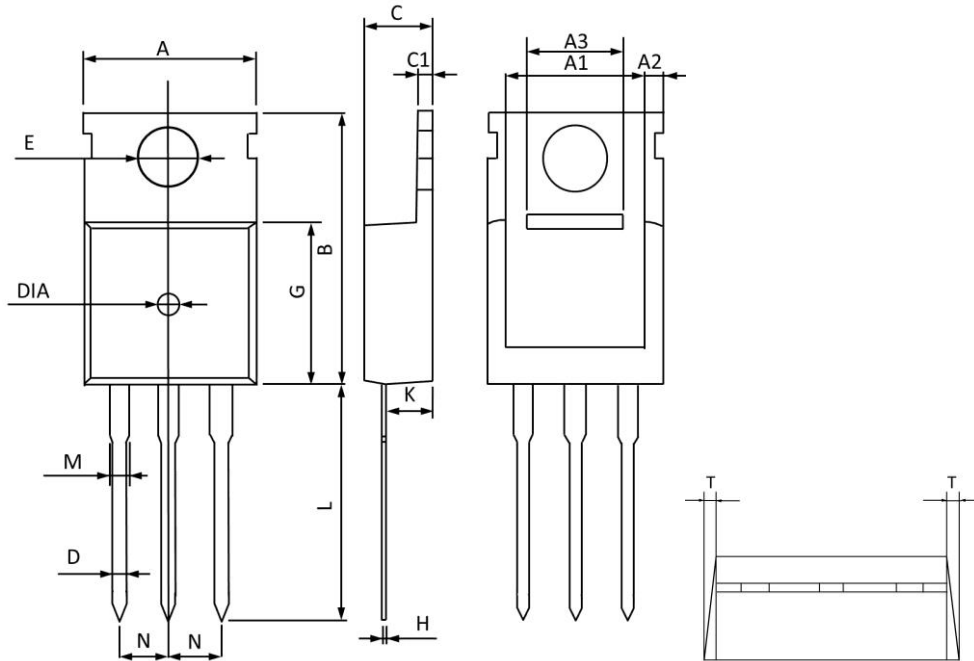


**Fig.7 Switching Time Waveform**



**Fig.8 EAS Waveform**

**TO220 PACKAGE INFORMATION**



Symbol	Dimensions In Millimeters		Dimensions In Inches	
	MAX	MIN	MAX	MIN
A	10.300	9.700	0.406	0.382
A1	8.840	8.440	0.348	0.332
A2	1.250	1.050	0.049	0.041
A3	5.300	5.100	0.209	0.201
B	16.200	15.400	0.638	0.606
C	4.680	4.280	0.184	0.169
C1	1.500	1.100	0.059	0.043
D	1.000	0.600	0.039	0.024
E	3.800	3.400	0.150	0.134
G	9.300	8.700	0.366	0.343
H	0.600	0.400	0.024	0.016
K	2.700	2.100	0.106	0.083
L	13.600	12.800	0.535	0.504
M	1.500	1.100	0.059	0.043
N	2.590	2.490	0.102	0.098
T	W0.35		W0.014	
DIA	Φ1.5 TYP.	deep0.2 TYP.	Φ0.059 TYP.	deep0.008 TYP.