

General Description

These N-Channel enhancement mode power field effect transistors are planar stripe, DMOS technology. This advanced technology has been especially tailored to minimize on-state resistance, provide superior switching performance, and withstand high energy pulse in the avalanche and commutation mode. These devices are well suited for high efficiency switch mode power supply

BVDSS	RDSON	ID
650V	1.2Ω	7A

Features

- Improved dv/dt capability
- Fast switching
- 100% EAS Guaranteed
- Green Device Available

TO251 Pin Configuration

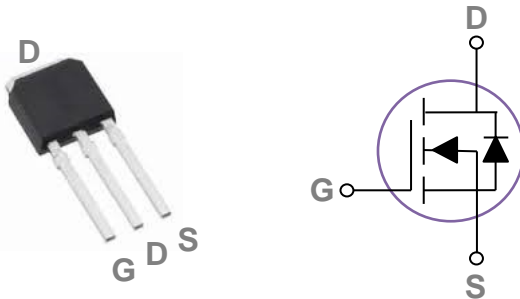

Applications

- High efficient switched mode power supplies
- TV Power
- Adapter/charger
- Server Power
- PV Inverter / UPS

Absolute Maximum Ratings Tc=25°C unless otherwise noted

Symbol	Parameter	Rating	Units
V _{DS}	Drain-Source Voltage	650	V
V _{GS}	Gate-Source Voltage	±30	V
I _D	Drain Current – Continuous (T _C =25°C)	7	A
	Drain Current – Continuous (T _C =100°C)	4.4	A
I _{DM}	Drain Current – Pulsed ¹	28	A
EAS	Single Pulse Avalanche Energy ²	605	mJ
IAS	Single Pulse Avalanche Current ²	11	A
P _D	Power Dissipation (T _C =25°C)	77	W
	Power Dissipation – Derate above 25°C	0.62	W/°C
T _{STG}	Storage Temperature Range	-55 to 150	°C
T _J	Operating Junction Temperature Range	-55 to 150	°C

Thermal Characteristics

Symbol	Parameter	Typ.	Max.	Unit
R _{θJA}	Thermal Resistance Junction to ambient	---	62	°C/W
R _{θJC}	Thermal Resistance Junction to Case	---	1.61	°C/W

Electrical Characteristics (T_J=25 °C, unless otherwise noted)
Off Characteristics

Symbol	Parameter	Conditions	Min.	Typ.	Max.	Unit
BV _{DSS}	Drain-Source Breakdown Voltage	V _{GS} =0V, I _D =250μA	650	---	---	V
I _{DSS}	Drain-Source Leakage Current	V _{DS} =650V, V _{GS} =0V, T _J =25°C	---	---	1	μA
		V _{DS} =520V, V _{GS} =0V, T _J =100°C	---	---	10	μA
I _{GSS}	Gate-Source Leakage Current	V _{GS} =±30V, V _{DS} =0V	---	---	±100	nA

On Characteristics

R _{DS(ON)}	Static Drain-Source On-Resistance	V _{GS} =10V, I _D =3A	---	1.0	1.2	Ω
V _{GS(th)}	Gate Threshold Voltage	V _{GS} =V _{DS} , I _D =250μA	2	3	4	V
g _{fs}	Forward Transconductance	V _{DS} =30V, I _D =3A	---	8	---	S

Dynamic and switching Characteristics

Q _g	Total Gate Charge ^{3,4}	V _{DS} =520V, V _{GS} =10V, I _D =4A	---	32	48	nC
Q _{gs}	Gate-Source Charge ^{3,4}		---	6.4	10	
Q _{gd}	Gate-Drain Charge ^{3,4}		---	11.8	18	
T _{d(on)}	Turn-On Delay Time ^{3,4}	V _{DD} =300V, V _{GS} =10V, R _G =25Ω I _D =4A	---	30	60	ns
T _r	Rise Time ^{3,4}		---	34	68	
T _{d(off)}	Turn-Off Delay Time ^{3,4}		---	72	144	
T _f	Fall Time ^{3,4}		---	28	56	
C _{iss}	Input Capacitance	V _{DS} =25V, V _{GS} =0V, F=1MHz	---	1100	1650	pF
C _{oss}	Output Capacitance		---	105	150	
C _{rss}	Reverse Transfer Capacitance		---	17	30	
R _g	Gate resistance	V _{GS} =0V, V _{DS} =0V, F=1MHz	---	2	---	Ω

Drain-Source Diode Characteristics and Maximum Ratings

Symbol	Parameter	Conditions	Min.	Typ.	Max.	Unit
I _S	Continuous Source Current	V _G =V _D =0V, Force Current	---	---	7	A
I _{SM}	Pulsed Source Current		---	---	14	A
V _{SD}	Diode Forward Voltage	V _{GS} =0V, I _S =1A, T _J =25°C	---	---	1	V

Note :

1. Repetitive Rating : Pulsed width limited by maximum junction temperature.
2. V_{DD}=50V, V_{GS}=10V, L=10mH, I_{AS}=11A., R_G=25Ω, Starting T_J=25°C.
3. The data tested by pulsed, pulse width ≤ 300us, duty cycle ≤ 2%.
4. Essentially independent of operating temperature.

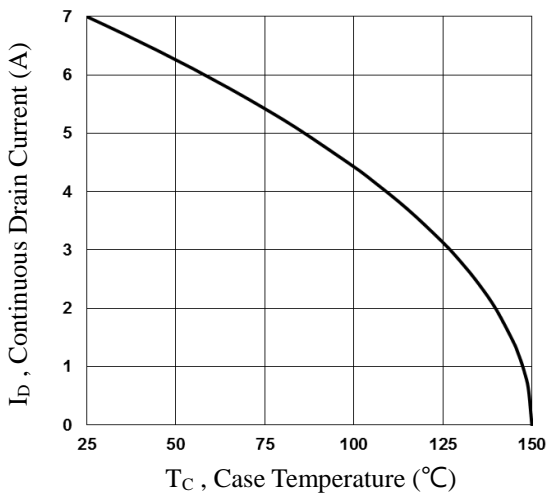

Fig.1 Continuous Drain Current vs. T_c

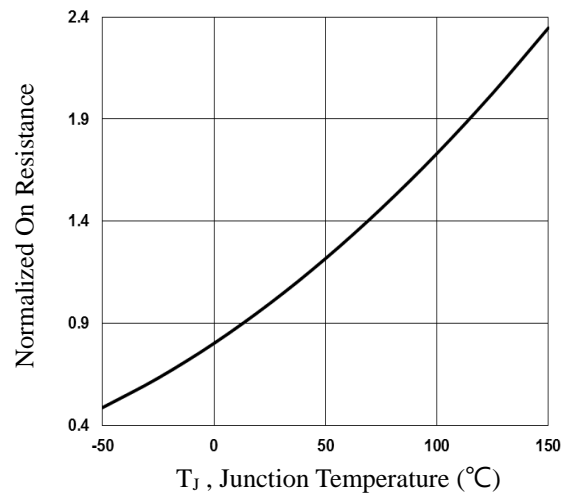

Fig.2 Normalized $R_{DS(on)}$ vs. T_j

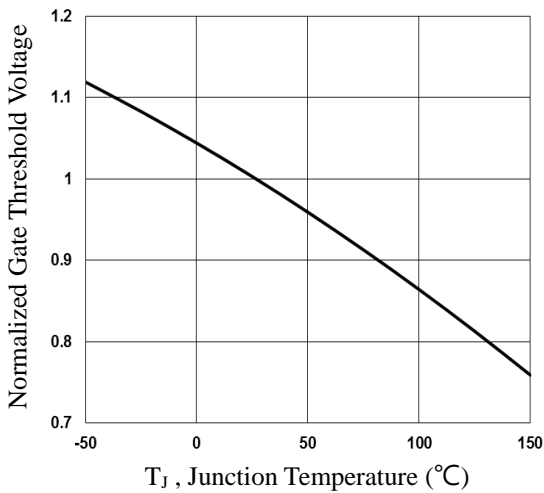

Fig.3 Normalized V_{th} vs. T_j

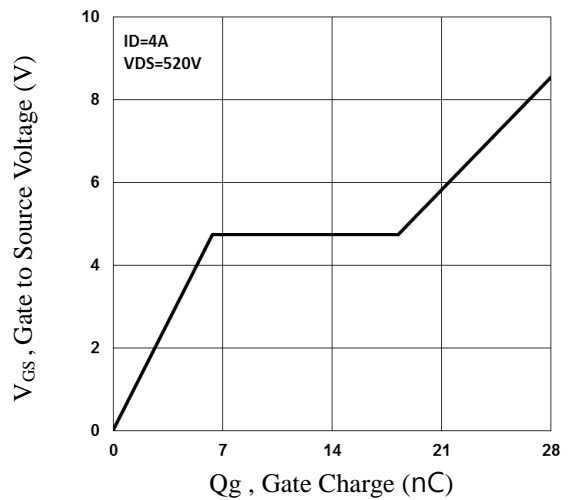

Fig.4 Gate Charge Waveform

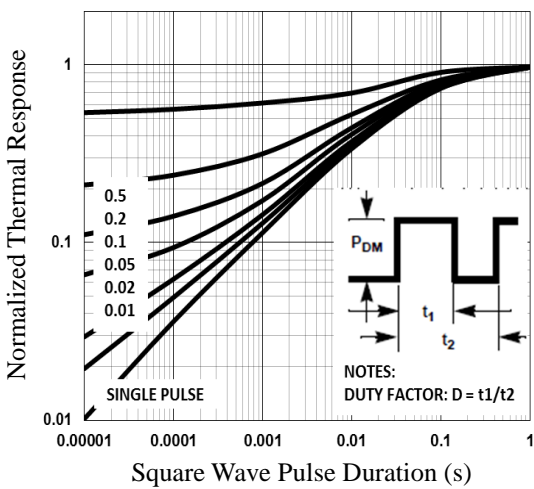

Fig.5 Normalized Transient Impedance

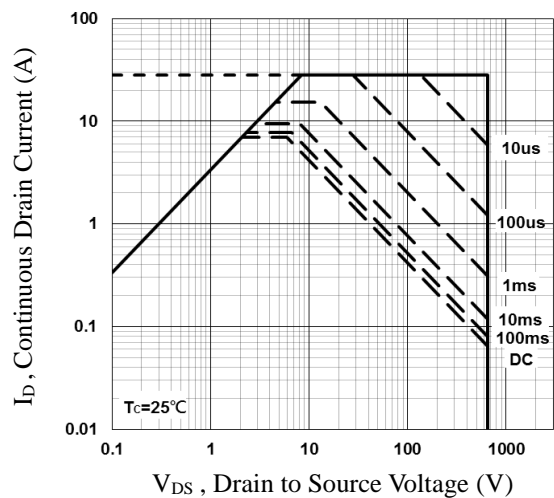

Fig.6 Maximum Safe Operation Area

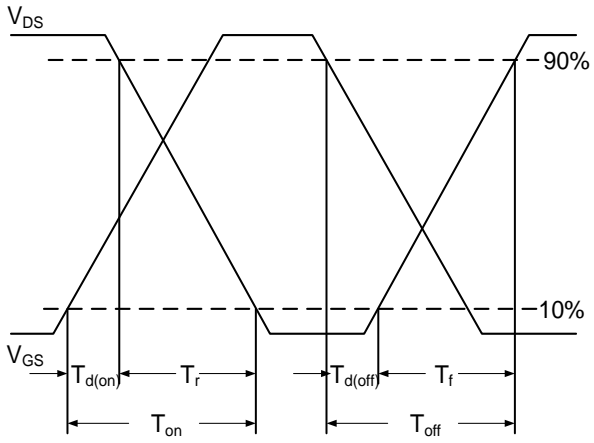

Fig.7 Switching Time Waveform

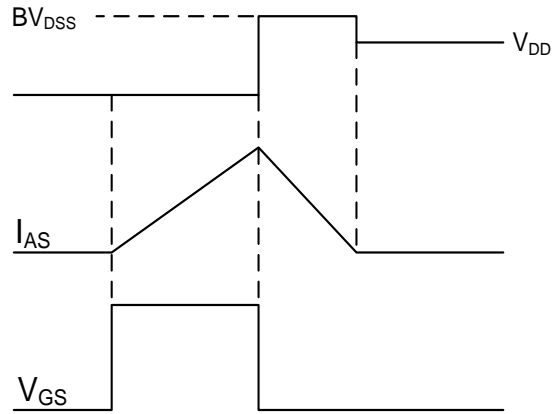
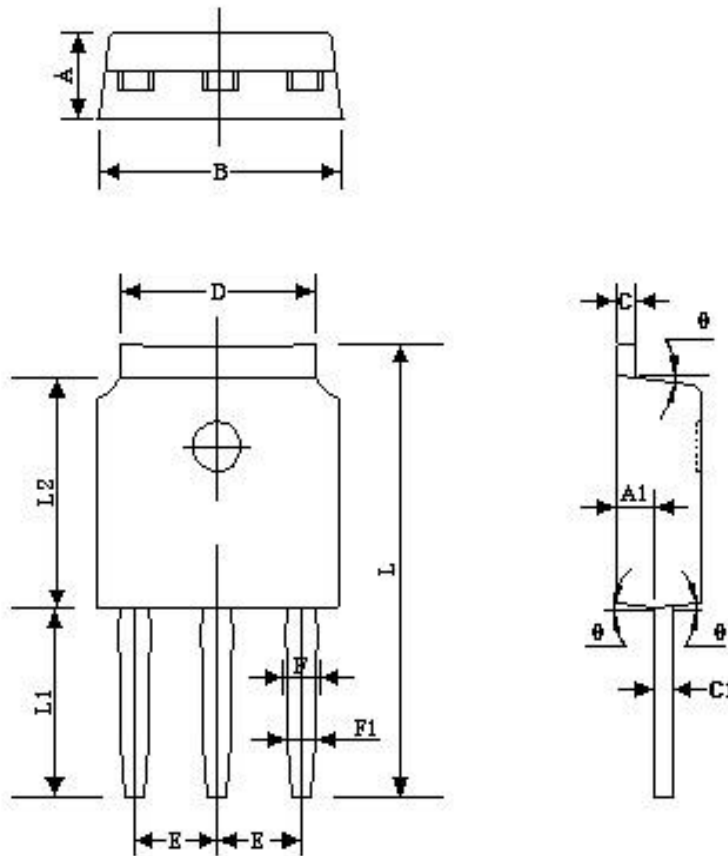

Fig.8 EAS Waveform

TO251 PACKAGE INFORMATION



Symbol	Dimensions In Millimeters		Dimensions In Inches	
	MAX	MIN	MAX	MIN
A	2.500	2.100	0.098	0.083
A1	1.250	0.900	0.049	0.035
B	6.800	6.400	0.268	0.252
C	0.580	0.420	0.023	0.017
C1	0.580	0.420	0.023	0.017
D	5.500	5.000	0.217	0.197
E	2.400	2.000	0.094	0.079
F	1.050	0.750	0.041	0.030
F1	0.900	0.650	0.035	0.026
L	12.400	11.600	0.488	0.457
L1	5.300	4.700	0.209	0.185
L2	6.300	5.700	0.248	0.224
θ	9°	3°	9°	3°