

General Description

These N-Channel enhancement mode power field effect transistors are using trench DMOS technology. This advanced technology has been especially tailored to minimize on-state resistance, provide superior switching performance, and withstand high energy pulse in the avalanche and commutation mode. These devices are well suited for high efficiency fast switching applications.

BVDSS	R _{DS(ON)}	I _D
100V	4.2 mΩ	170A

Features

- 100V, 170A, R_{DS(ON)} = 4.2mΩ @ V_{GS} = 10V
- Improved dv/dt capability
- Fast switching
- 100% EAS Guaranteed
- Green Device Available

TO247 Pin Configuration

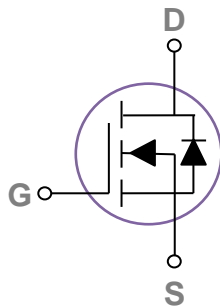
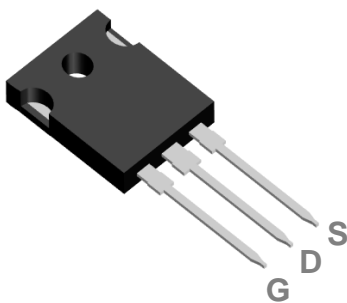

Applications

- Networking
- Load Switch
- LED applications
- Quick Charger

Absolute Maximum Ratings T_C=25°C unless otherwise noted

Symbol	Parameter	Rating	Units
V _{DS}	Drain-Source Voltage	100	V
V _{GS}	Gate-Source Voltage	+20/-12	V
I _D	Drain Current – Continuous (T _C =25°C)	170	A
	Drain Current – Continuous (T _C =100°C)	105	A
I _{DM}	Drain Current – Pulsed ¹	680	A
EAS	Single Pulse Avalanche Energy ²	378	mJ
IAS	Single Pulse Avalanche Current ²	87	A
P _D	Power Dissipation (T _C =25°C)	335	W
	Power Dissipation – Derate above 25°C	2.7	W/°C
T _{STG}	Storage Temperature Range	-55 to 150	°C
T _J	Operating Junction Temperature Range	-55 to 150	°C

Thermal Characteristics

Symbol	Parameter	Typ.	Max.	Unit
R _{θJA}	Thermal Resistance Junction to ambient	---	62	°C/W
R _{θJC}	Thermal Resistance Junction to Case	---	0.37	°C/W

Electrical Characteristics (T_J=25 °C, unless otherwise noted)
Off Characteristics

Symbol	Parameter	Conditions	Min.	Typ.	Max.	Unit
BV _{DSS}	Drain-Source Breakdown Voltage	V _{GS} =0V , I _D =250uA	100	---	---	V
I _{DSS}	Drain-Source Leakage Current	V _{DS} =100V , V _{GS} =0V , T _J =25°C	---	---	1	uA
		V _{DS} =80V , V _{GS} =0V , T _J =85°C	---	---	10	uA
I _{GSS}	Gate-Source Leakage Current	V _{GS} =20V , V _{DS} =0V	---	---	100	nA

On Characteristics

R _{DS(ON)}	Static Drain-Source On-Resistance	V _{GS} =10V , I _D =20A	---	3.6	4.2	mΩ
		V _{GS} =4.5V , I _D =15A	---	4.5	6	mΩ
V _{GS(th)}	Gate Threshold Voltage	V _{GS} =V _{DS} , I _D =250uA	1.2	1.8	2.5	V
g _{fs}	Forward Transconductance	V _{DS} =10V , I _D =3A	---	20	---	S

Dynamic and switching Characteristics

Q _g	Total Gate Charge ^{3, 4}	V _{DS} =80V , V _{GS} =10V , I _D =10A	---	110	165	nC
Q _{gs}	Gate-Source Charge ^{3, 4}		---	11.5	18	
Q _{gd}	Gate-Drain Charge ^{3, 4}		---	28	42	
T _{d(on)}	Turn-On Delay Time ^{3, 4}	V _{DD} =50V , V _{GS} =10V , R _G =6Ω I _D =1A	---	23	46	ns
T _r	Rise Time ^{3, 4}		---	32	64	
T _{d(off)}	Turn-Off Delay Time ^{3, 4}		---	157	320	
T _f	Fall Time ^{3, 4}		---	115	230	
C _{iss}	Input Capacitance	V _{DS} =25V , V _{GS} =0V , F=1MHz	---	6680	13300	pF
C _{oss}	Output Capacitance		---	1690	3380	
C _{rss}	Reverse Transfer Capacitance		---	78	156	
R _g	Gate resistance	V _{GS} =0V , V _{DS} =0V , F=1MHz	---	1.9	---	Ω

Drain-Source Diode Characteristics and Maximum Ratings

Symbol	Parameter	Conditions	Min.	Typ.	Max.	Unit
I _S	Continuous Source Current	V _G =V _D =0V , Force Current	---	---	170	A
I _{SM}	Pulsed Source Current		---	---	340	A
V _{SD}	Diode Forward Voltage	V _{GS} =0V , I _S =1A , T _J =25°C	---	---	1	V

Note :

1. Repetitive Rating : Pulsed width limited by maximum junction temperature.
2. V_{DD}=25V, V_{GS}=10V, L=0.1mH, I_{AS}=87A., R_G=25Ω, Starting T_J=25°C.
3. The data tested by pulsed , pulse width ≤ 300us , duty cycle ≤ 2%.
4. Essentially independent of operating temperature.

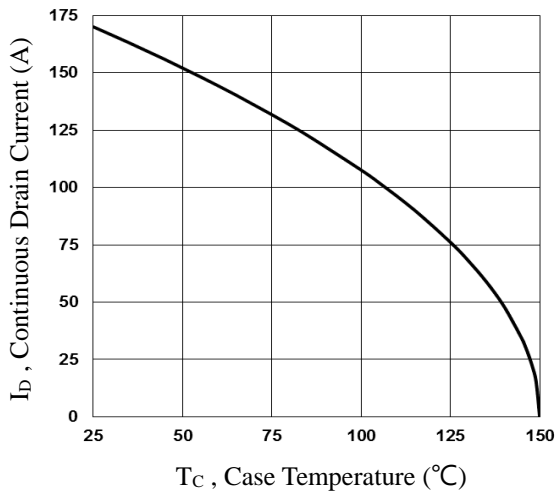

Fig.1 Continuous Drain Current vs. T_c

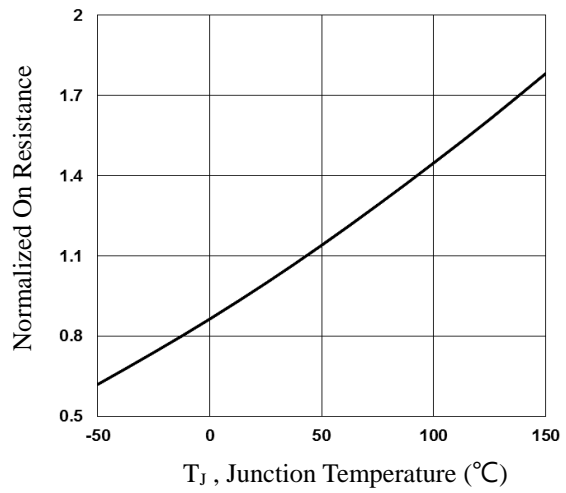

Fig.2 Normalized $R_{DS(on)}$ vs. T_j

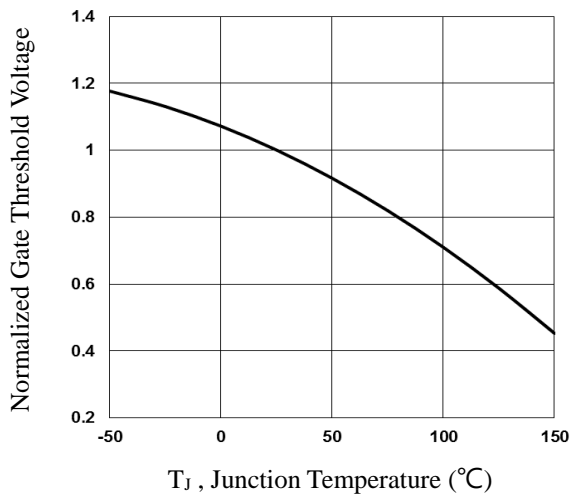

Fig.3 Normalized V_{th} vs. T_j

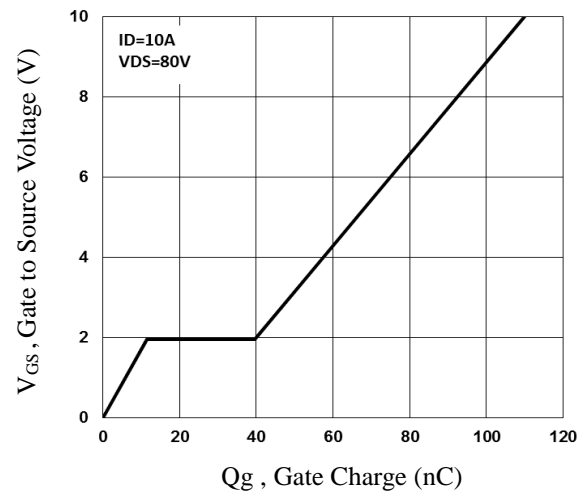

Fig.4 Gate Charge Characteristics

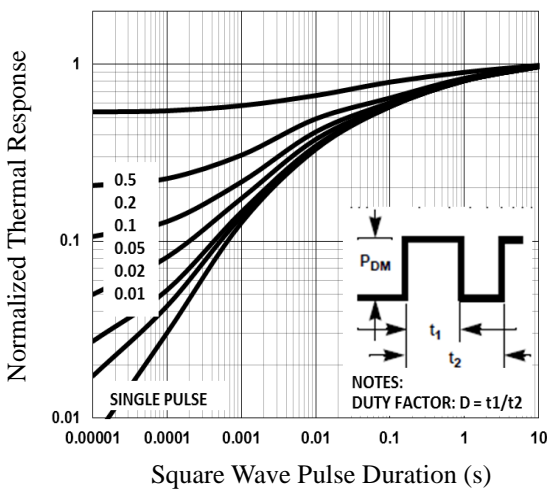

Fig.5 Normalized Transient Impedance

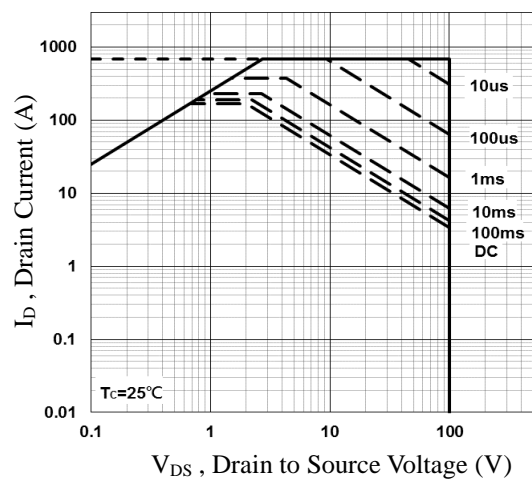

Fig.6 Maximum Safe Operation Area

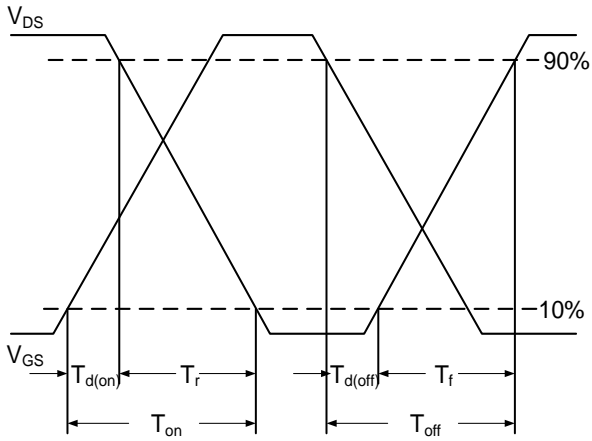
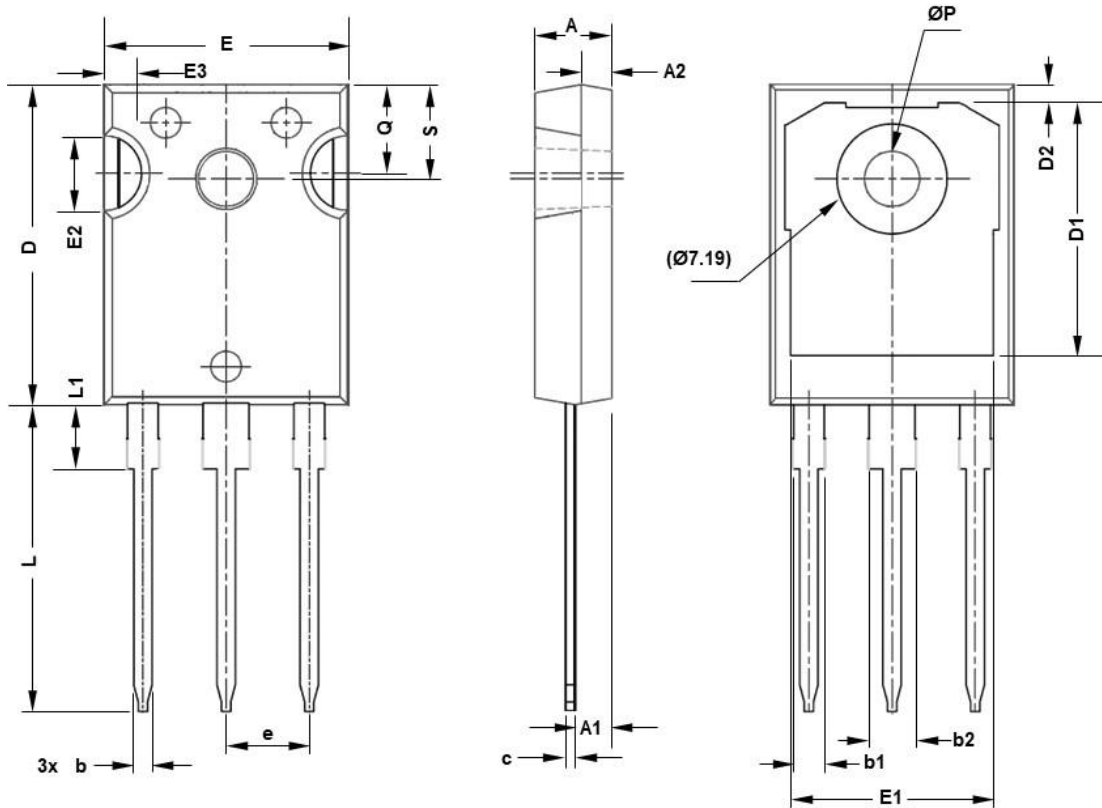

Fig.7 Switching Time Waveform



Fig.8 Gate Charge Waveform

TO247 PACKAGE INFORMATION



SYMBOL	mm		SYMBOL	mm	
	MIN	MAX		MIN	MAX
A	4.83	5.21	E2	4.32	5.49
A1	2.29	2.55	E3	2.15	2.80
A2	1.50	2.49	e	5.44BSC	
b	1.12	1.33	L	19.81	20.32
b1	1.91	2.39	L1	4.10	4.40
b2	2.87	3.22	ΦP	3.56	3.65
C	0.55	0.69	Q	5.39	6.20
D	20.80	21.10	S	6.04	6.30
D1	16.25	17.65			
D2	0.51	1.35			
E	15.75	16.13			
E1	13.46	14.16			