

General Description

These P-Channel enhancement mode power field effect transistors are using trench DMOS technology. This advanced technology has been especially tailored to minimize on-state resistance, provide superior switching performance, and withstand high energy pulse in the avalanche and commutation mode. These devices are well suited for high efficiency fast switching applications.

BVDSS	RDSON	ID
-60V	47mΩ	-4A

Features

- -60V,-4A, RDS(ON) 47mΩ @VGS = -10V
- Improved dv/dt capability
- Fast switching
- Green Device Available

SOP8 Pin Configuration

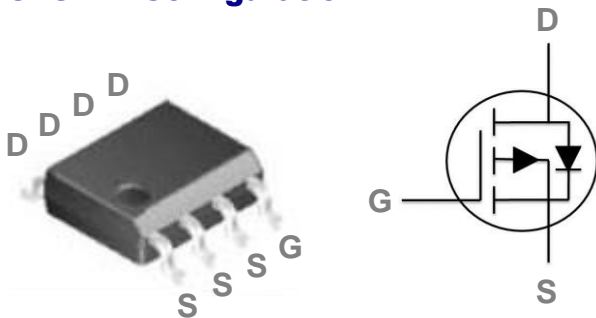

Applications

- Networking
- Load Switch
- LED applications

Absolute Maximum Ratings (Tc=25°C unless otherwise noted)

Symbol	Parameter	Rating	Units
V _{DS}	Drain-Source Voltage	-60	V
V _{GS}	Gate-Source Voltage	±20	V
I _D	Drain Current – Continuous (T _A =25°C)	-4	A
	Drain Current – Continuous (T _A =70°C)	-3.2	A
I _{DM}	Drain Current – Pulsed ¹	-16	A
EAS	Single Pulse Avalanche Energy ²	58	mJ
IAS	Single Pulse Avalanche Current ²	-34	A
P _D	Power Dissipation (T _A =25°C)	2	W
	Power Dissipation – Derate above 25°C	0.016	W/°C
T _{STG}	Storage Temperature Range	-55 to 150	°C
T _J	Operating Junction Temperature Range	-55 to 150	°C

Thermal Characteristics

Symbol	Parameter	Typ.	Max.	Unit
R _{θJA}	Thermal Resistance Junction to ambient	---	62.5	°C/W

Electrical Characteristics (T_J=25 °C, unless otherwise noted)
Off Characteristics

Symbol	Parameter	Conditions	Min.	Typ.	Max.	Unit
BV _{DSS}	Drain-Source Breakdown Voltage	V _{GS} =0V, I _D =-250uA	-60	---	---	V
I _{DSS}	Drain-Source Leakage Current	V _{DS} =-60V, V _{GS} =0V, T _J =25°C	---	---	-1	uA
		V _{DS} =-48V, V _{GS} =0V, T _J =125°C	---	---	-10	uA
I _{GSS}	Gate-Source Leakage Current	V _{GS} =±20V, V _{DS} =0V	---	---	±100	nA

On Characteristics

R _{DS(ON)}	Static Drain-Source On-Resistance	V _{GS} =-10V, I _D =-4A	---	41	47	mΩ
		V _{GS} =-4.5V, I _D =-3A	---	53	64	mΩ
V _{GS(th)}	Gate Threshold Voltage	V _{GS} =V _{DS} , I _D =-250uA	-1.2	-1.6	-2.5	V
g _{fs}	Forward Transconductance	V _{DS} =-10V, I _S =-1A	---	5	---	S

Dynamic and switching Characteristics

Q _g	Total Gate Charge ^{2, 3}	V _{DS} =-30V, V _{GS} =-10V, I _D =-2A	---	19	30	nC
Q _{gs}	Gate-Source Charge ^{2, 3}		---	2.5	3.8	
Q _{gd}	Gate-Drain Charge ^{2, 3}		---	4.3	6.5	
T _{d(on)}	Turn-On Delay Time ^{2, 3}	V _{DD} =-30V, V _{GS} =-10V, R _G =6Ω I _D =-2A	---	18	27	ns
T _r	Rise Time ^{2, 3}		---	8	12	
T _{d(off)}	Turn-Off Delay Time ^{2, 3}		---	100	150	
T _f	Fall Time ^{2, 3}		---	30	45	
C _{iss}	Input Capacitance	V _{DS} =-30V, V _{GS} =0V, F=1MHz	---	1200	1800	pF
C _{oss}	Output Capacitance		---	85	128	
C _{rss}	Reverse Transfer Capacitance		---	60	90	
R _g	Gate resistance	V _{GS} =0V, V _{DS} =0V, F=1MHz	---	14	---	Ω

Drain-Source Diode Characteristics and Maximum Ratings

Symbol	Parameter	Conditions	Min.	Typ.	Max.	Unit
I _S	Continuous Source Current	V _G =V _D =0V, Force Current	---	---	-4	A
I _{SM}	Pulsed Source Current		---	---	-8	A
V _{SD}	Diode Forward Voltage	V _{GS} =0V, I _S =-1A, T _J =25°C	---	---	-1	V
t _{rr}	Reverse Recovery Time	V _R =-50V, I _S =-2A	---	30	---	ns
Q _{rr}	Reverse Recovery Charge	di/dt=100A/μs, T _J =25°C	---	20	---	nC

Note :

1. Repetitive Rating : Pulsed width limited by maximum junction temperature.
2. V_{DD}=-25V, V_{GS}=-10V, L=0.1mH, I_{AS}=-34A., Starting T_J=25°C
3. The data tested by pulsed , pulse width ≤ 300us , duty cycle ≤ 2%.
4. Essentially independent of operating temperature.

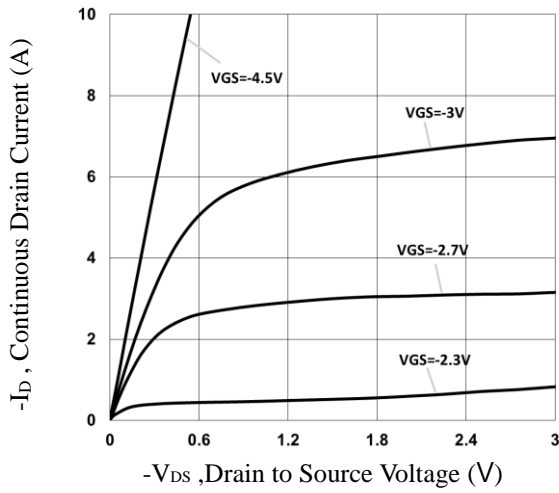

Fig.1 Typical Output Characteristics

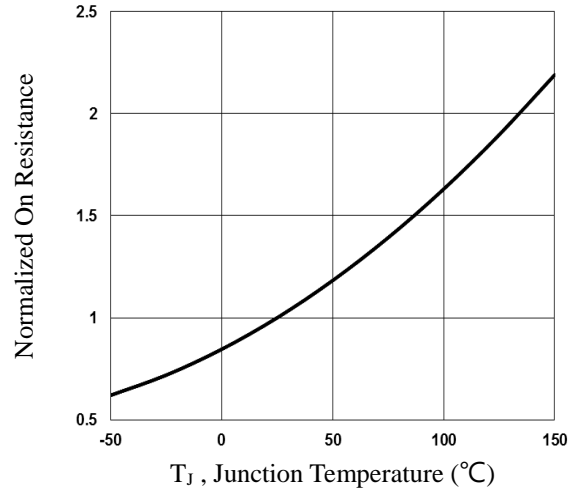

Fig.2 Normalized RDS(on) vs. TJ

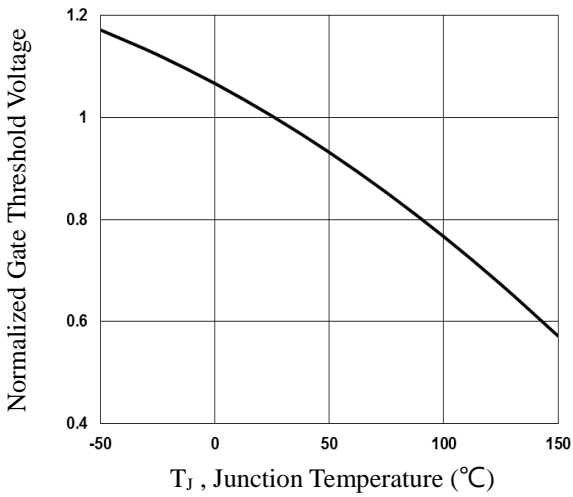

Fig.3 Normalized Vth vs. TJ

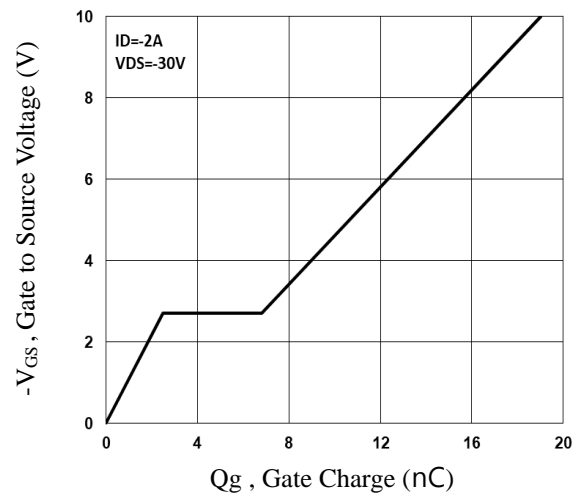

Fig.4 Gate Charge Waveform

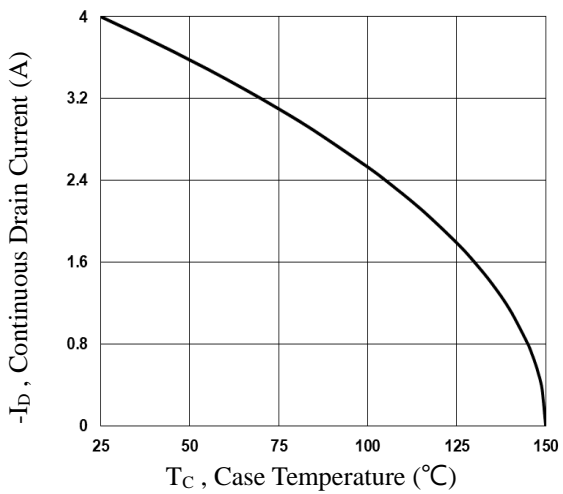

Fig.5 Continuous Drain Current vs. TC

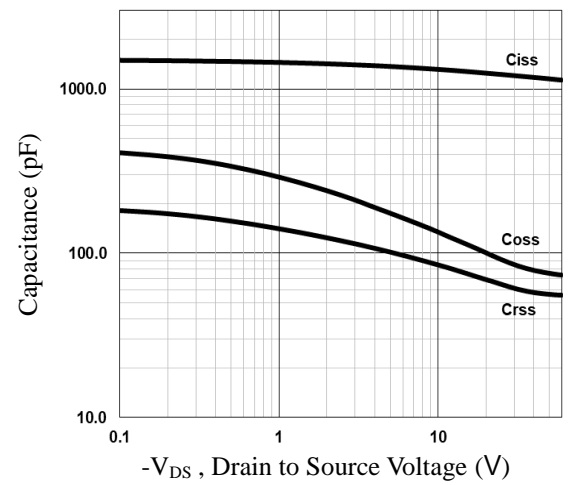

Fig.6 Capacitance Characteristics

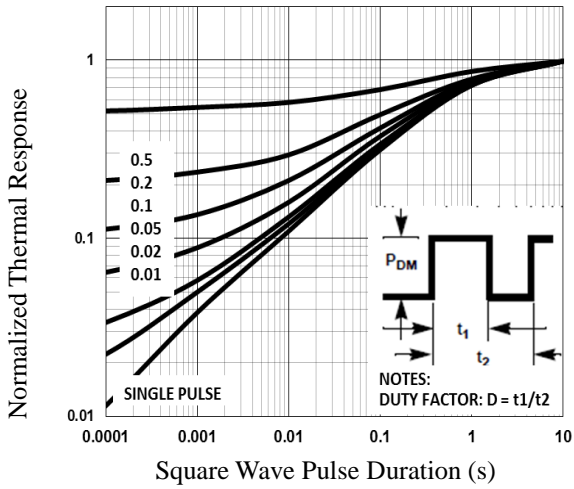

Fig.7 Normalized Transient Impedance

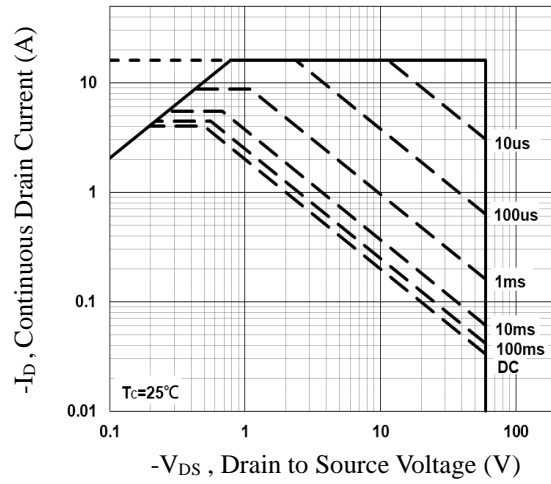

Fig.8 Maximum Safe Operation Area

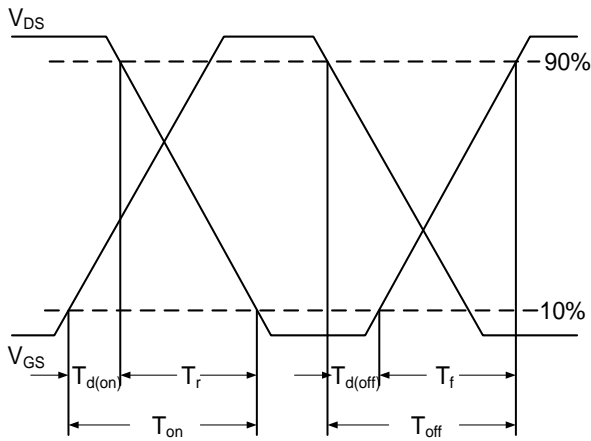

Fig.9 Switching Time Waveform

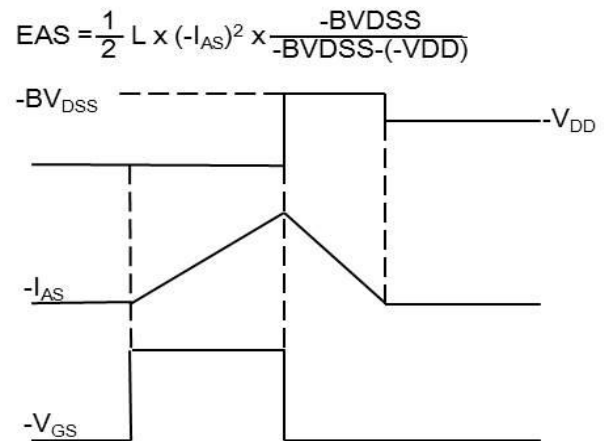
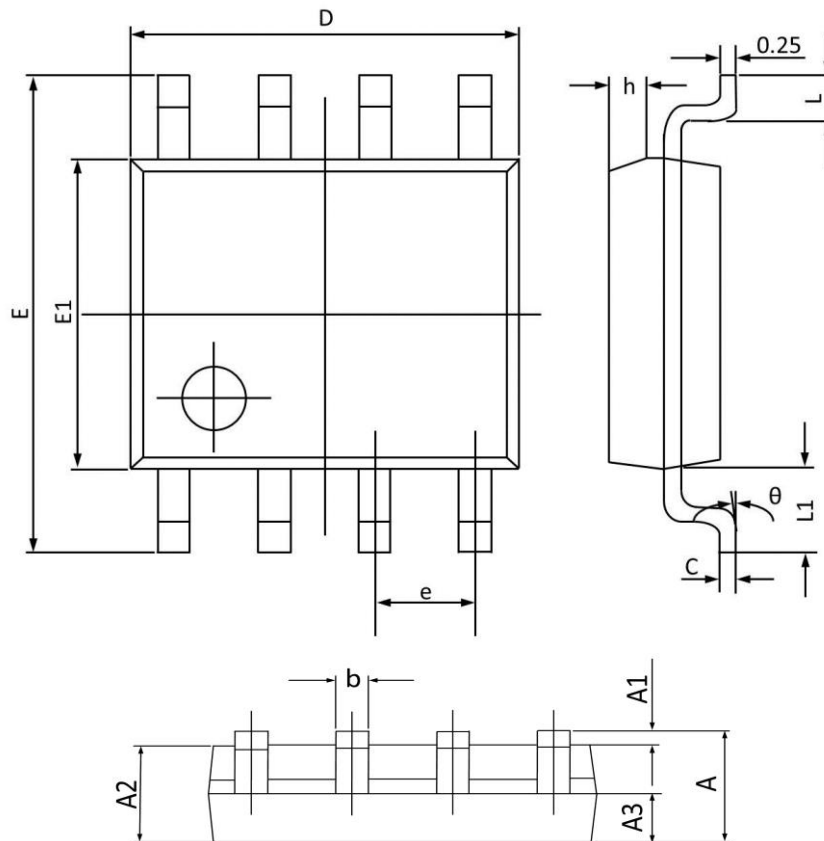

Fig.10 EAS Waveform

SOP8 PACKAGE INFORMATION



Symbol	Dimensions In Millimeters		Dimensions In Inches	
	Min	Max	Min	Max
A	1.350	1.800	0.053	0.069
A1	0.050	0.250	0.002	0.010
A2	1.250	1.650	0.049	0.065
A3	0.500	0.700	0.020	0.028
b	0.300	0.510	0.012	0.020
c	0.150	0.260	0.006	0.010
D	4.700	5.100	0.185	0.201
E	5.800	6.200	0.228	0.244
E1	3.700	4.100	0.146	0.161
e	1.270(BSC)		0.050(BSC)	
h	0.250	0.500	0.010	0.020
L	0.400	1.000	0.016	0.039
L1	1.050(BSC)		0.041(BSC)	
θ	0°	8°	0°	8°