

### General Description

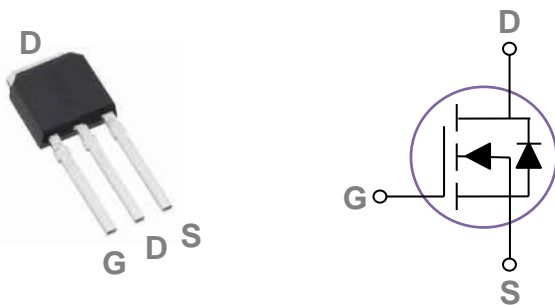
These N-Channel enhancement mode power field effect transistors are using trench DMOS technology. This advanced technology has been especially tailored to minimize on-state resistance, provide superior switching performance, and withstand high energy pulse in the avalanche and commutation mode. These devices are well suited for high efficiency fast switching applications.

BVDSS	RDSON	ID
65V	3.3mΩ	95A

### Features

- 65V,95A,  $R_{DS(ON)} = 3.3m\Omega @ V_{GS} = 10V$
- Improved  $dv/dt$  capability
- Fast switching
- 100% EAS Guaranteed
- Green Device Available

### TO251 Pin Configuration



### Applications

- Networking
- Load Switch
- LED applications
- Quick Charger

### Absolute Maximum Ratings $T_c=25^\circ\text{C}$ unless otherwise noted

Symbol	Parameter	Rating	Units
$V_{DS}$	Drain-Source Voltage	65	V
$V_{GS}$	Gate-Source Voltage	+20/-12	V
$I_D$	Drain Current – Continuous ( $T_c=25^\circ\text{C}$ )	95	A
	Drain Current – Continuous ( $T_c=100^\circ\text{C}$ )	60	A
$I_{DM}$	Drain Current – Pulsed <sup>1</sup>	380	A
EAS	Single Pulse Avalanche Energy <sup>2</sup>	245	mJ
IAS	Single Pulse Avalanche Current <sup>2</sup>	70	A
$P_D$	Power Dissipation ( $T_c=25^\circ\text{C}$ )	130	W
	Power Dissipation – Derate above $25^\circ\text{C}$	1.04	W/ $^\circ\text{C}$
$T_{STG}$	Storage Temperature Range	-55 to 150	$^\circ\text{C}$
$T_J$	Operating Junction Temperature Range	-55 to 150	$^\circ\text{C}$

### Thermal Characteristics

Symbol	Parameter	Typ.	Max.	Unit
$R_{\theta JA}$	Thermal Resistance Junction to ambient	---	62	$^\circ\text{C}/\text{W}$
$R_{\theta JC}$	Thermal Resistance Junction to Case	---	0.96	$^\circ\text{C}/\text{W}$

**Electrical Characteristics (T<sub>J</sub>=25 °C, unless otherwise noted)**
**Off Characteristics**

Symbol	Parameter	Conditions	Min.	Typ.	Max.	Unit
BV <sub>DSS</sub>	Drain-Source Breakdown Voltage	V <sub>GS</sub> =0V, I <sub>D</sub> =250uA	65	---	---	V
ΔBV <sub>DSS</sub> /ΔT <sub>J</sub>	BV <sub>DSS</sub> Temperature Coefficient	Reference to 25°C, I <sub>D</sub> =1mA	---	0.05	---	V/°C
I <sub>DSS</sub>	Drain-Source Leakage Current	V <sub>DS</sub> =60V, V <sub>GS</sub> =0V, T <sub>J</sub> =25°C	---	---	1	uA
		V <sub>DS</sub> =48V, V <sub>GS</sub> =0V, T <sub>J</sub> =85°C	---	---	10	uA
I <sub>GSS</sub>	Gate-Source Leakage Current	V <sub>GS</sub> =20V, V <sub>DS</sub> =0V	---	---	100	nA

**On Characteristics**

R <sub>DS(ON)</sub>	Static Drain-Source On-Resistance	V <sub>GS</sub> =10V, I <sub>D</sub> =20A	---	2.5	3.3	mΩ
		V <sub>GS</sub> =4.5V, I <sub>D</sub> =10A	---	4.6	6	mΩ
V <sub>GS(th)</sub>	Gate Threshold Voltage	V <sub>GS</sub> =V <sub>DS</sub> , I <sub>D</sub> =250uA	1	1.6	2.5	V
ΔV <sub>GS(th)</sub>	V <sub>GS(th)</sub> Temperature Coefficient		---	-5	---	mV/°C
g <sub>fs</sub>	Forward Transconductance	V <sub>DS</sub> =10V, I <sub>D</sub> =5A	---	11	---	S

**Dynamic and switching Characteristics**

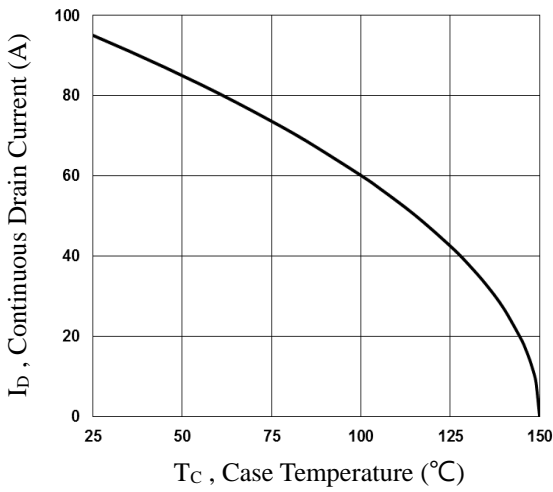
Q <sub>g</sub>	Total Gate Charge <sup>3, 4</sup>	V <sub>DS</sub> =48V, V <sub>GS</sub> =10V, I <sub>D</sub> =10A	---	59	120	nC
Q <sub>gs</sub>	Gate-Source Charge <sup>3, 4</sup>		---	10.4	20	
Q <sub>gd</sub>	Gate-Drain Charge <sup>3, 4</sup>		---	19.6	38	
T <sub>d(on)</sub>	Turn-On Delay Time <sup>3, 4</sup>	V <sub>DD</sub> =30V, V <sub>GS</sub> =10V, R <sub>G</sub> =6Ω I <sub>D</sub> =1A	---	22	44	ns
T <sub>r</sub>	Rise Time <sup>3, 4</sup>		---	14	28	
T <sub>d(off)</sub>	Turn-Off Delay Time <sup>3, 4</sup>		---	40	80	
T <sub>f</sub>	Fall Time <sup>3, 4</sup>		---	20	40	
C <sub>iss</sub>	Input Capacitance	V <sub>DS</sub> =25V, V <sub>GS</sub> =0V, F=1MHz	---	4780	9500	pF
C <sub>oss</sub>	Output Capacitance		---	1365	2700	
C <sub>rss</sub>	Reverse Transfer Capacitance		---	51	102	
R <sub>g</sub>	Gate resistance		V <sub>GS</sub> =0V, V <sub>DS</sub> =0V, F=1MHz	---	1.8	

**Drain-Source Diode Characteristics and Maximum Ratings**

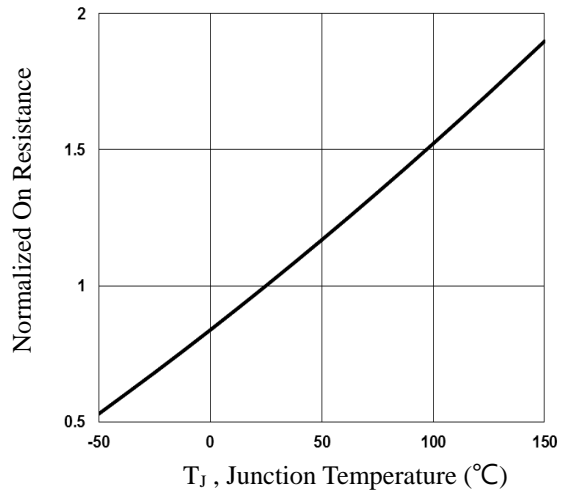
Symbol	Parameter	Conditions	Min.	Typ.	Max.	Unit
I <sub>S</sub>	Continuous Source Current	V <sub>G</sub> =V <sub>D</sub> =0V, Force Current	---	---	95	A
I <sub>SM</sub>	Pulsed Source Current		---	---	190	A
V <sub>SD</sub>	Diode Forward Voltage	V <sub>GS</sub> =0V, I <sub>S</sub> =1A, T <sub>J</sub> =25°C	---	---	1	V
t <sub>rr</sub>	Reverse Recovery Time	V <sub>R</sub> =50V, I <sub>S</sub> =10A	---	70	---	ns
Q <sub>rr</sub>	Reverse Recovery Charge	di/dt=100A/μs, T <sub>J</sub> =25°C	---	140	---	nC

Note :

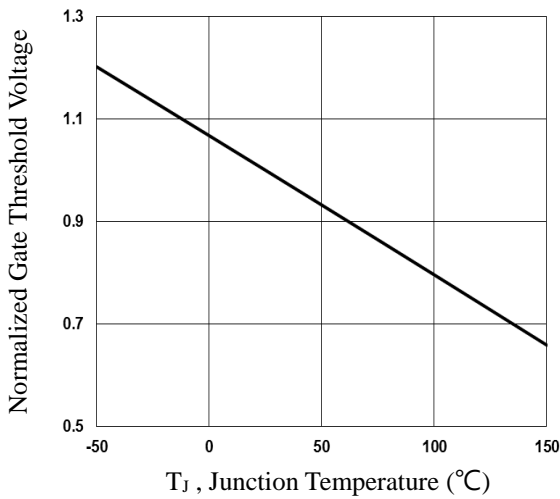
1. Repetitive Rating : Pulsed width limited by maximum junction temperature.
2. V<sub>DD</sub>=25V, V<sub>GS</sub>=10V, L=0.1mH, I<sub>AS</sub>=70A., R<sub>G</sub>=25Ω, Starting T<sub>J</sub>=25°C.
3. The data tested by pulsed, pulse width ≤ 300us, duty cycle ≤ 2%.
4. Essentially independent of operating temperature.



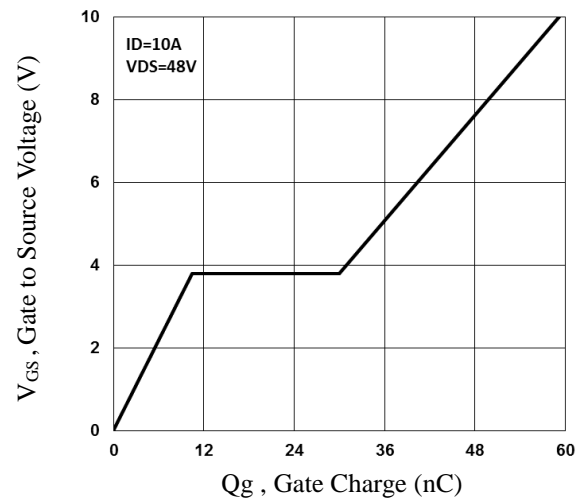
**Fig.1 Continuous Drain Current vs.  $T_c$**



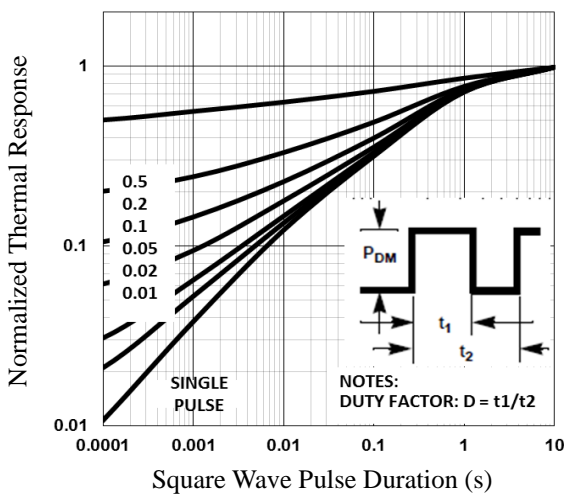
**Fig.2 Normalized  $R_{DS(on)}$  vs.  $T_j$**



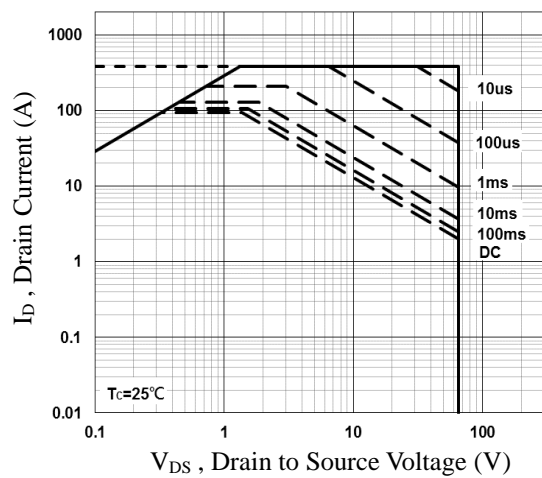
**Fig.3 Normalized  $V_{th}$  vs.  $T_j$**



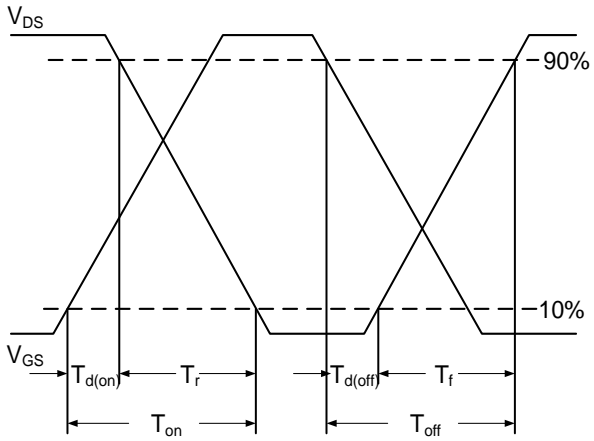
**Fig.4 Gate Charge Characteristics**



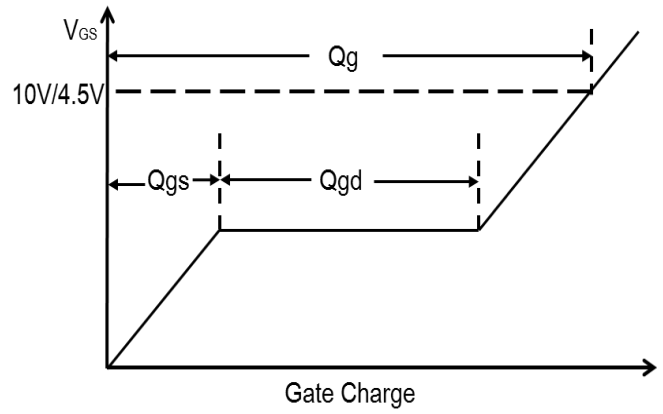
**Fig.5 Normalized Transient Impedance**



**Fig.6 Maximum Safe Operation Area**

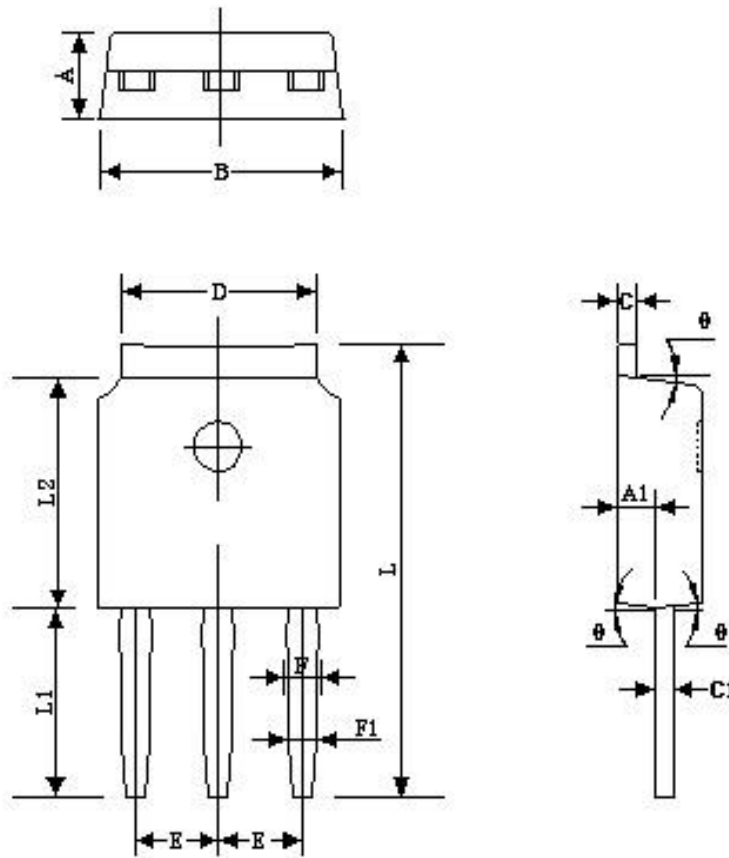


**Fig.7 Switching Time Waveform**



**Fig.8 Gate Charge Waveform**

## TO251 PACKAGE INFORMATION



Symbol	Dimensions In Millimeters		Dimensions In Inches	
	MAX	MIN	MAX	MIN
A	2.500	2.100	0.098	0.083
A1	1.250	0.900	0.049	0.035
B	6.800	6.400	0.268	0.252
C	0.580	0.420	0.023	0.017
C1	0.580	0.420	0.023	0.017
D	5.500	5.000	0.217	0.197
E	2.400	2.000	0.094	0.079
F	1.050	0.750	0.041	0.030
F1	0.900	0.650	0.035	0.026
L	12.400	11.600	0.488	0.457
L1	5.300	4.700	0.209	0.185
L2	6.300	5.700	0.248	0.224
$\theta$	9°	3°	9°	3°