

General Description

These N-Channel enhancement mode power field effect transistors are using trench DMOS technology. This advanced technology has been especially tailored to minimize on-state resistance, provide superior switching performance, and withstand high energy pulse in the avalanche and commutation mode. These devices are well suited for high efficiency fast switching applications.

SOT23-3S Pin Configuration

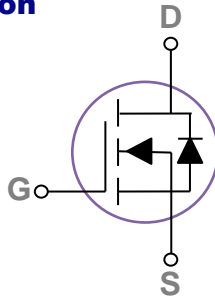
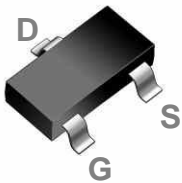

BVDSS	RDSON	ID
20V	25mΩ	5.8A

Features

- 20V, 5.8A, $R_{DS(ON)} = 25m\Omega @ V_{GS} = 4.5V$
- Improved dv/dt capability
- Fast switching
- Green Device Available
- Suit for 1.8V Gate Drive Applications

Applications

- Notebook
- Load Switch
- Hand-Held Instruments

Absolute Maximum Ratings $T_c=25^\circ C$ unless otherwise noted

Symbol	Parameter	Rating	Units
V_{DS}	Drain-Source Voltage	20	V
V_{GS}	Gate-Source Voltage	± 10	V
I_D	Drain Current – Continuous ($T_A=25^\circ C$)	5.8	A
	Drain Current – Continuous ($T_A=70^\circ C$)	4.6	A
I_{DM}	Drain Current – Pulsed ¹	23.2	A
P_D	Power Dissipation ($T_A=25^\circ C$)	1.56	W
	Power Dissipation – Derate above $25^\circ C$	0.012	W/ $^\circ C$
T_{STG}	Storage Temperature Range	-55 to 150	$^\circ C$
T_J	Operating Junction Temperature Range	-55 to 150	$^\circ C$

Thermal Characteristics

Symbol	Parameter	Typ.	Max.	Unit
$R_{\theta JA}$	Thermal Resistance Junction to ambient	---	80	$^\circ C/W$

Electrical Characteristics (T_J=25 °C, unless otherwise noted)
Off Characteristics

Symbol	Parameter	Conditions	Min.	Typ.	Max.	Unit
BV _{DSS}	Drain-Source Breakdown Voltage	V _{GS} =0V , I _D =250μA	20	---	---	V
ΔBV _{DSS} /ΔT _J	BV _{DSS} Temperature Coefficient	Reference to 25°C , I _D =1mA	---	0.02	---	V/°C
I _{DSS}	Drain-Source Leakage Current	V _{DS} =16V , V _{GS} =0V , T _J =25°C	---	---	1	μA
		V _{DS} =16V , V _{GS} =0V , T _J =85°C	---	---	10	μA
I _{GSS}	Gate-Source Leakage Current	V _{GS} =±10V , V _{DS} =0V	---	---	±100	nA

On Characteristics

R _{DS(ON)}	Static Drain-Source On-Resistance	V _{GS} =4.5V , I _D =4A	---	20	25	mΩ
		V _{GS} =2.5V , I _D =3A	---	27	35	
		V _{GS} =1.8V , I _D =2A	---	39	55	
V _{GS(th)}	Gate Threshold Voltage	V _{GS} =V _{DS} , I _D =250μA	0.4	0.6	0.8	V
ΔV _{GS(th)}	V _{GS(th)} Temperature Coefficient		---	-2	---	mV/°C
g _{fs}	Forward Transconductance	V _{DS} =10V , I _S =3A	---	6.5	---	S

Dynamic and switching Characteristics

Q _g	Total Gate Charge ^{2, 3}	V _{DS} =10V , V _{GS} =4.5V , I _D =4A	---	7.7	11	nC
Q _{gs}	Gate-Source Charge ^{2, 3}		---	0.9	1	
Q _{gd}	Gate-Drain Charge ^{2, 3}		---	2.4	5	
T _{d(on)}	Turn-On Delay Time ^{2, 3}	V _{DD} =10V , V _{GS} =4.5V , R _G =25Ω I _D =1A	---	4.1	8	ns
T _r	Rise Time ^{2, 3}		---	11.6	22	
T _{d(off)}	Turn-Off Delay Time ^{2, 3}		---	23.9	45	
T _f	Fall Time ^{2, 3}		---	7.6	14	
C _{iss}	Input Capacitance	V _{DS} =10V , V _{GS} =0V , F=1MHz	---	535	775	pF
C _{oss}	Output Capacitance		---	60	85	
C _{rss}	Reverse Transfer Capacitance		---	34	50	

Drain-Source Diode Characteristics and Maximum Ratings

Symbol	Parameter	Conditions	Min.	Typ.	Max.	Unit
I _S	Continuous Source Current	V _G =V _D =0V , Force Current	---	---	5.8	A
I _{SM}	Pulsed Source Current		---	---	11.6	A
V _{SD}	Diode Forward Voltage	V _{GS} =0V , I _S =1A , T _J =25°C	---	---	1	V

Note :

1. Repetitive Rating : Pulsed width limited by maximum junction temperature.
2. The data tested by pulsed , pulse width ≤ 300μs , duty cycle ≤ 2%.
3. Essentially independent of operating temperature.

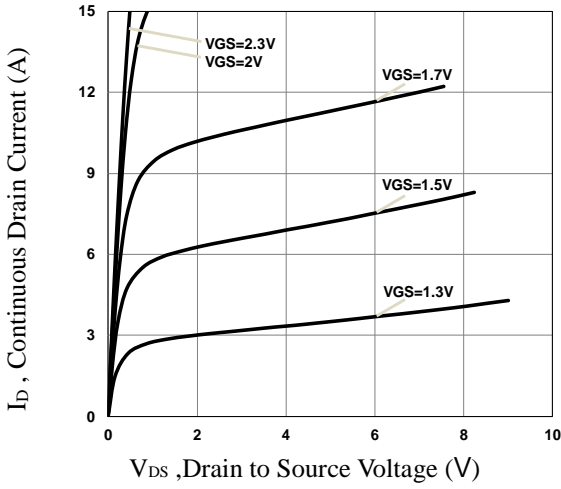

Fig.1 Typical Output Characteristics

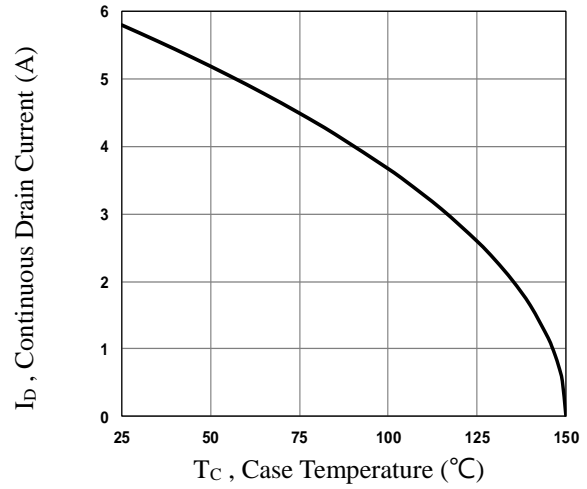

Fig.2 Continuous Drain Current vs. T_c

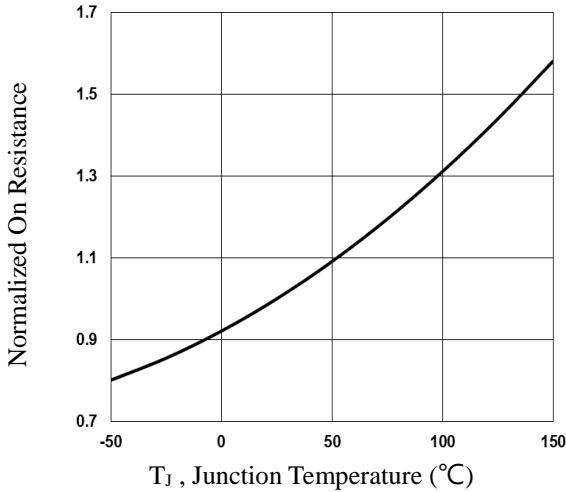

Fig.3 Normalized $R_{DS(on)}$ vs. T_j

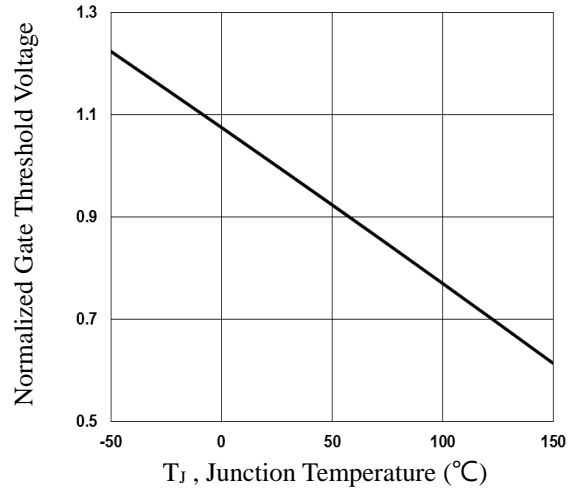

Fig.4 Normalized V_{th} vs. T_j

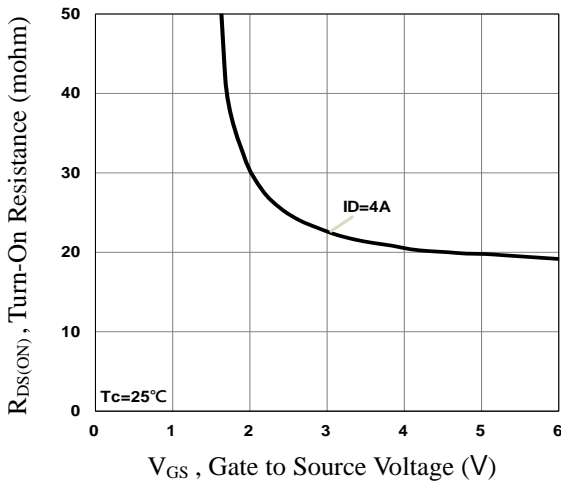

Fig.5 Turn-On Resistance vs. V_{GS}

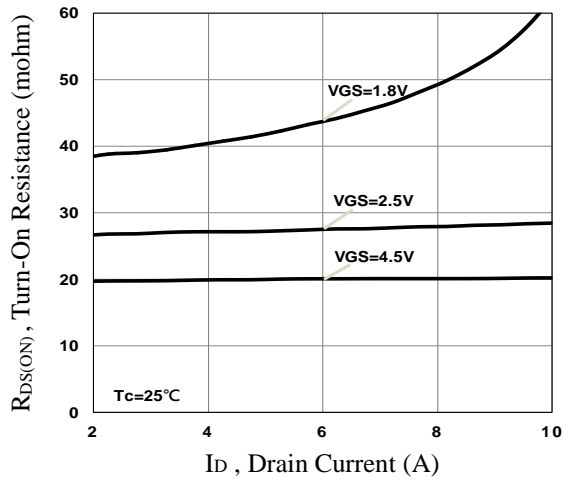

Fig.6 Turn-On Resistance vs. I_D

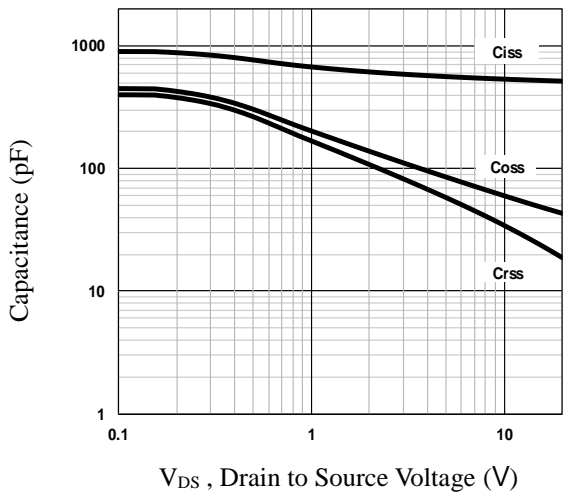

Fig.7 Capacitance Characteristics

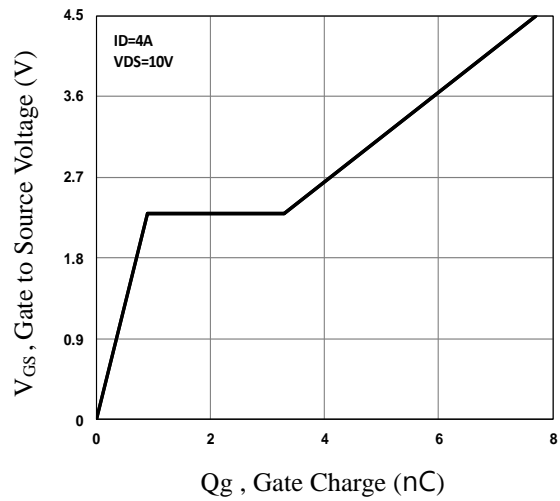

Fig.8 Gate Charge Characteristics

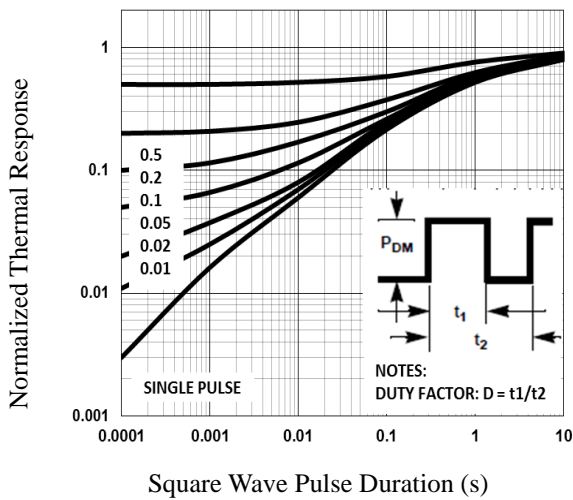

Fig.9 Normalized Transient Impedance

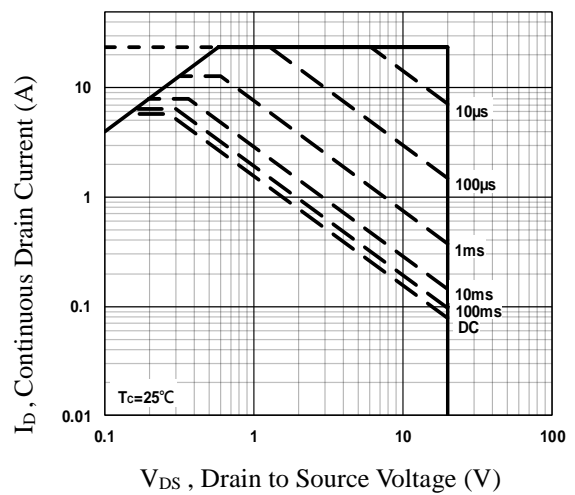

Fig.10 Maximum Safe Operation Area

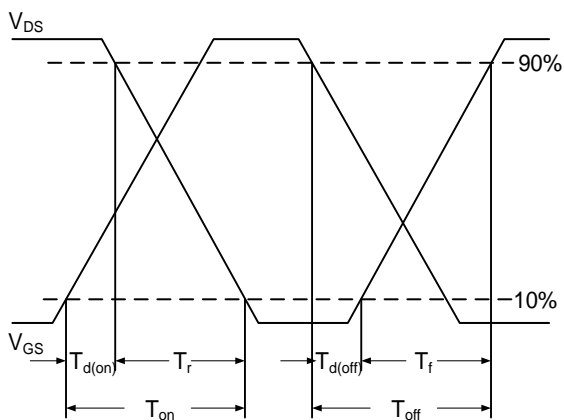

Fig.11 Switching Time Waveform

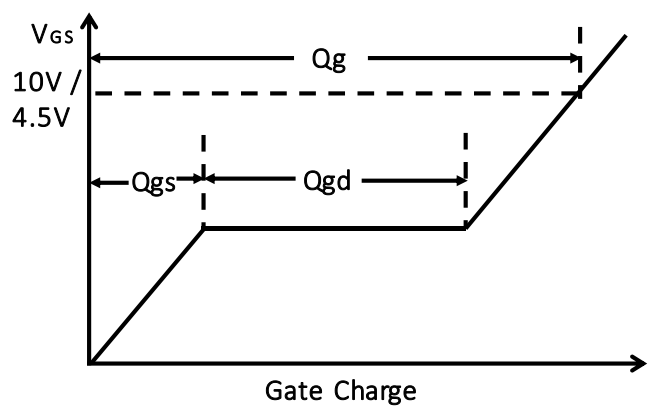
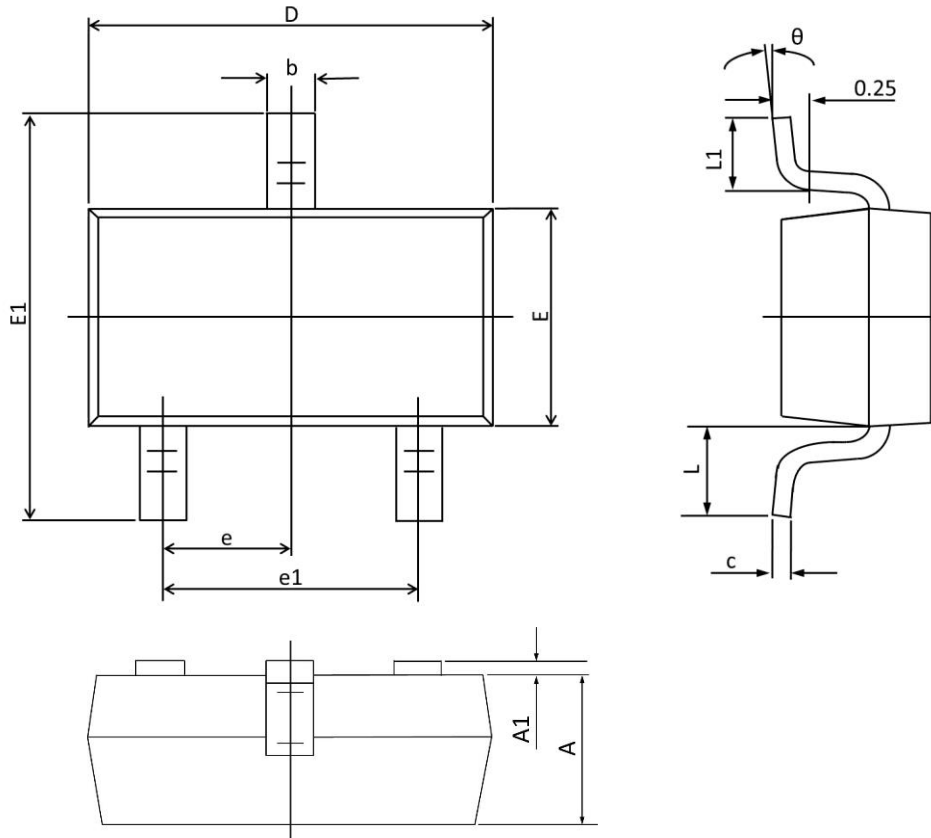

Fig.12 Gate Charge Waveform

SOT23-3S PACKAGE INFORMATION



Symbol	Dimensions In Millimeters		Dimensions In Inches	
	Min	Max	Min	Max
A	0.900	1.150	0.035	0.045
A1	0.001	0.100	0.000	0.004
b	0.300	0.500	0.012	0.020
c	0.080	0.180	0.003	0.008
D	2.700	3.100	0.106	0.122
E	1.100	1.500	0.043	0.059
E1	2.100	2.640	0.080	0.104
e	0.950 TYP.		0.037 TYP.	
e1	1.780	2.040	0.070	0.080
L	0.550 REF.		0.022 REF.	
L1	0.100	0.500	0.004	0.020
θ	1°	10°	1°	10°