

General Description

These P-Channel enhancement mode power field effect transistors are using trench DMOS technology. This advanced technology has been especially tailored to minimize on-state resistance, provide superior switching performance, and withstand high energy pulse in the avalanche and commutation mode. These devices are well suited for high efficiency fast switching applications.

SOT323 Pin Configuration

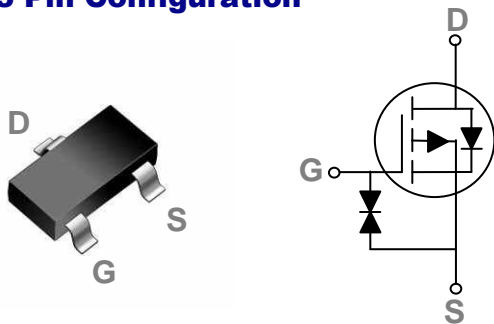

BVDSS	RDSON	ID
-20V	600mΩ	-400mA

Features

- -20V,-400mA, $R_{DS(ON)} = 600m\Omega @ V_{GS} = -4.5V$
- Improved dv/dt capability
- Fast switching
- Green Device Available
- Suit for -1.5V Gate Drive Applications

Applications

- Notebook
- Load Switch
- Battery Protection
- Hand-held Instruments

Absolute Maximum Ratings $T_C=25^\circ C$ unless otherwise noted

Symbol	Parameter	Rating	Units
V_{DS}	Drain-Source Voltage	-20	V
V_{GS}	Gate-Source Voltage	± 8	V
I_D	Drain Current – Continuous ($T_C=25^\circ C$)	-400	mA
	Drain Current – Continuous ($T_C=100^\circ C$)	-250	mA
I_{DM}	Drain Current – Pulsed ¹	-1.6	A
P_D	Power Dissipation ($T_C=25^\circ C$)	275	mW
	Power Dissipation – Derate above $25^\circ C$	2.2	mW/ $^\circ C$
T_{STG}	Storage Temperature Range	-55 to 150	$^\circ C$
T_J	Operating Junction Temperature Range	-55 to 150	$^\circ C$

Thermal Characteristics

Symbol	Parameter	Typ.	Max.	Unit
$R_{\theta JA}$	Thermal Resistance Junction to ambient	---	450	$^\circ C/W$

Electrical Characteristics ($T_J=25^\circ\text{C}$, unless otherwise noted)
Off Characteristics

Symbol	Parameter	Conditions	Min.	Typ.	Max.	Unit
BV_{DSS}	Drain-Source Breakdown Voltage	$V_{GS}=0V, I_D=-250\mu A$	-20	---	---	V
$\Delta BV_{DSS}/\Delta T_J$	BV_{DSS} Temperature Coefficient	Reference to 25°C , $I_D=-1\text{mA}$	---	-0.01	---	$V/^\circ\text{C}$
I_{DSS}	Drain-Source Leakage Current	$V_{DS}=-20V, V_{GS}=0V, T_J=25^\circ\text{C}$	---	---	-1	μA
		$V_{DS}=-16V, V_{GS}=0V, T_J=125^\circ\text{C}$	---	---	-10	μA
I_{GSS}	Gate-Source Leakage Current	$V_{GS}=\pm 8V, V_{DS}=0V$	---	---	± 20	μA

On Characteristics

$R_{DS(ON)}$	Static Drain-Source On-Resistance	$V_{GS}=-4.5V, I_D=-0.3A$	---	440	600	m Ω
		$V_{GS}=-2.5V, I_D=-0.2A$	---	610	850	
		$V_{GS}=-1.8V, I_D=-0.1A$	---	810	1200	
		$V_{GS}=-1.5V, I_D=-0.1A$	---	1020	1600	
		$V_{GS}=-1.2V, I_D=-0.1A$	---	1800	3000	
$V_{GS(th)}$	Gate Threshold Voltage	$V_{GS}=V_{DS}, I_D=-250\mu A$	-0.3	-0.6	-1.0	V
$\Delta V_{GS(th)}$	$V_{GS(th)}$ Temperature Coefficient		---	3	---	$\text{mV}/^\circ\text{C}$

Dynamic and switching Characteristics

Q_g	Total Gate Charge ^{2,3}	$V_{DS}=-10V, V_{GS}=-4.5V, I_D=-0.2A$	---	1	2	nC
Q_{gs}	Gate-Source Charge ^{2,3}		---	0.28	0.5	
Q_{gd}	Gate-Drain Charge ^{2,3}		---	0.18	0.4	
$T_{d(on)}$	Turn-On Delay Time ^{2,3}	$V_{DD}=-10V, V_{GS}=-4.5V, R_G=10\Omega, I_D=-0.2A$	---	8	16	ns
T_r	Rise Time ^{2,3}		---	5.2	10	
$T_{d(off)}$	Turn-Off Delay Time ^{2,3}		---	30	60	
T_f	Fall Time ^{2,3}		---	18	36	
C_{iss}	Input Capacitance	$V_{DS}=-10V, V_{GS}=0V, F=1\text{MHz}$	---	40	78	pF
C_{oss}	Output Capacitance		---	15	30	
C_{rss}	Reverse Transfer Capacitance		---	6.5	13	

Drain-Source Diode Characteristics and Maximum Ratings

Symbol	Parameter	Conditions	Min.	Typ.	Max.	Unit
I_S	Continuous Source Current	$V_G=V_D=0V, \text{Force Current}$	---	---	-0.4	A
I_{SM}	Pulsed Source Current		---	---	-0.8	A
V_{SD}	Diode Forward Voltage	$V_{GS}=0V, I_S=-0.2A, T_J=25^\circ\text{C}$	---	---	-1	V

Note :

1. Repetitive Rating : Pulsed width limited by maximum junction temperature.
2. The data tested by pulsed , pulse width $\leq 300\mu s$, duty cycle $\leq 2\%$.
3. Essentially independent of operating temperature.

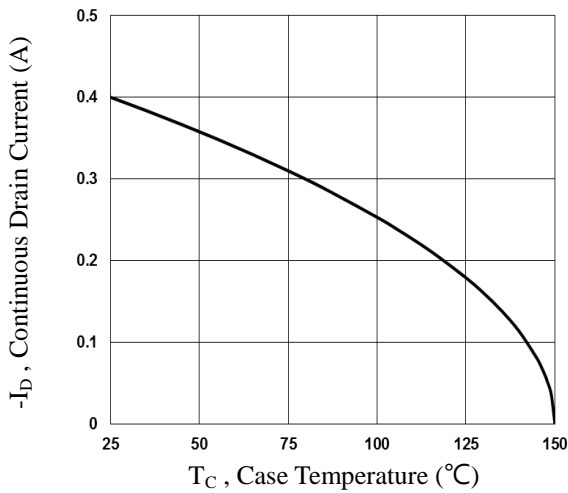

Fig.1 Continuous Drain Current vs. T_c

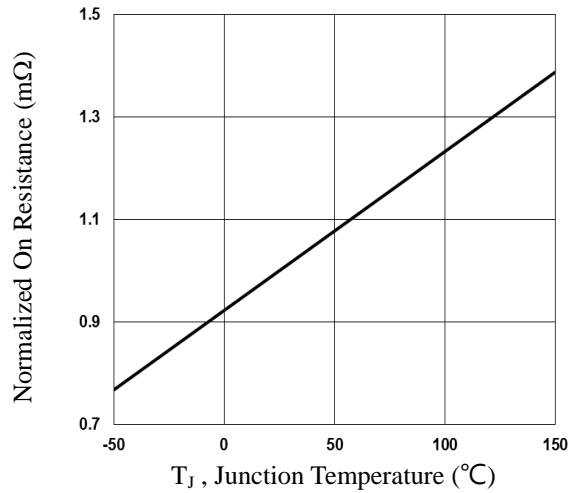

Fig.2 Normalized $R_{DS(on)}$ vs. T_j

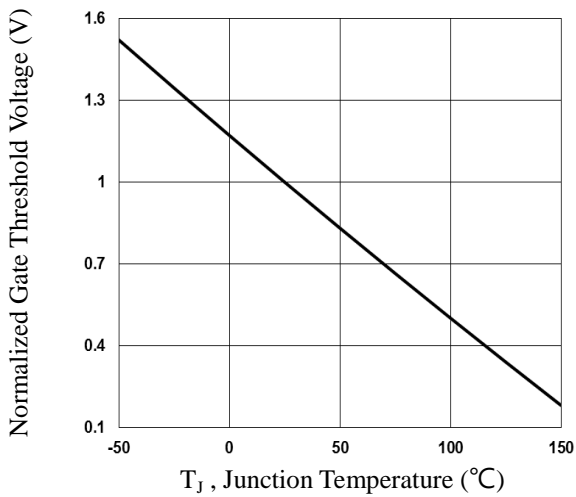

Fig.3 Normalized V_{th} vs. T_j

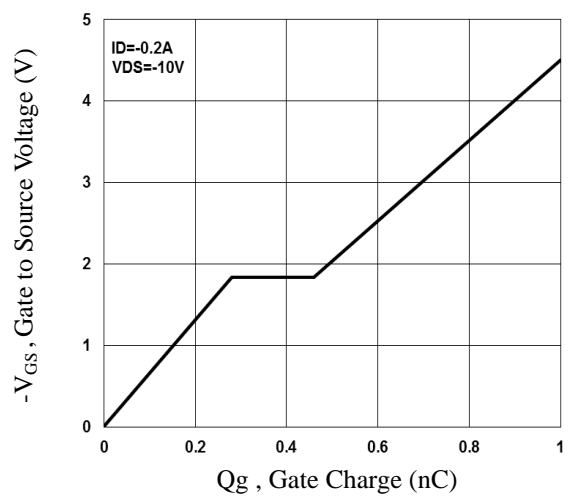

Fig.4 Gate Charge Waveform

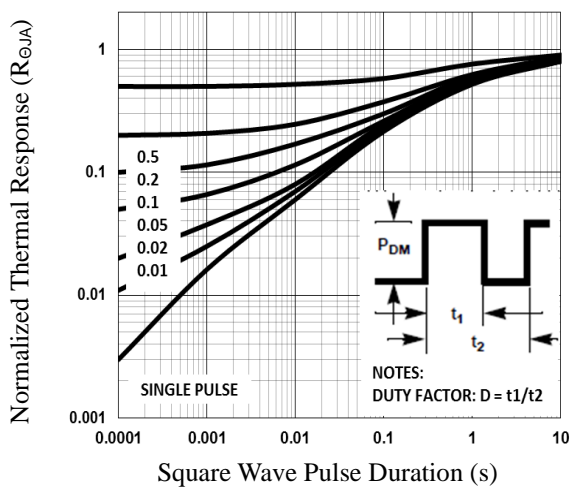

Fig.5 Normalized Transient Response

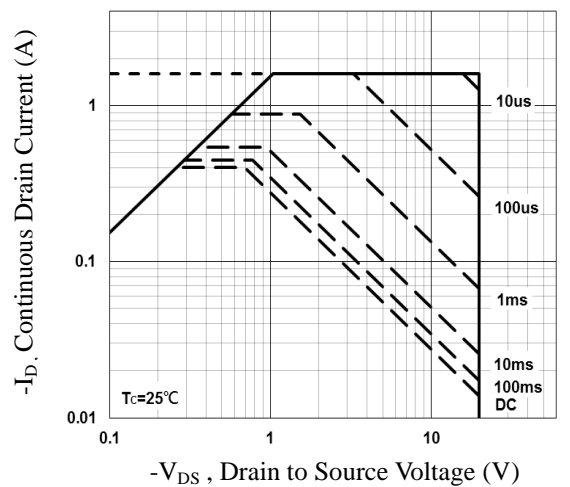

Fig.6 Maximum Safe Operation Area

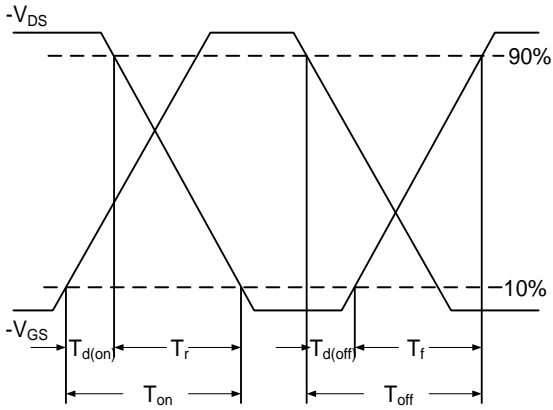

Fig.7 Switching Time Waveform

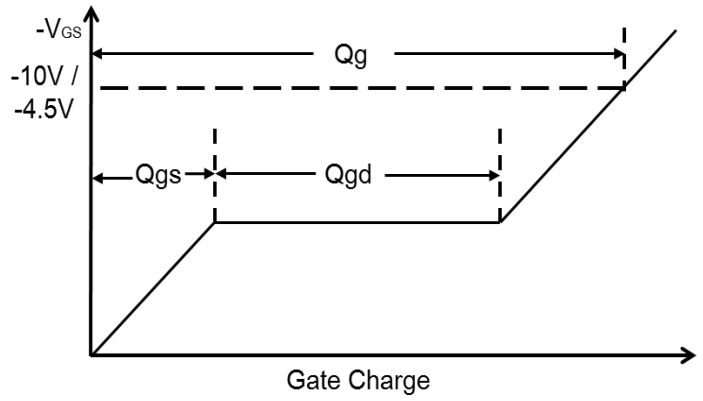
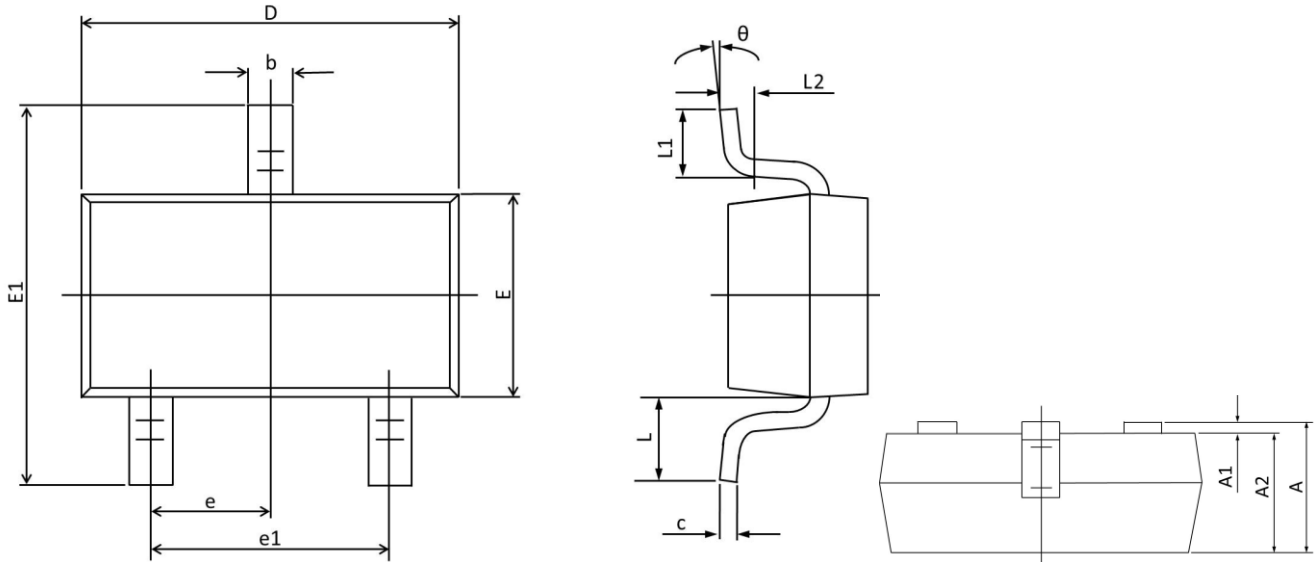

Fig.8 Gate Charge Waveform

SOT323 PACKAGE INFORMATION



Symbol	Dimensions In Millimeters		Dimensions In Inches	
	MAX	MIN	MAX	MIN
A	1.100	0.800	0.043	0.031
A1	0.100	0.000	0.004	0.000
A2	1.000	0.800	0.039	0.031
b	0.400	0.200	0.016	0.008
c	0.250	0.080	0.010	0.003
D	2.200	1.800	0.087	0.071
E	1.350	1.150	0.053	0.045
E1	2.450	1.800	0.096	0.071
e	0.65BSC		0.026BSC	
e1	1.400	1.200	0.055	0.047
L	0.525REF.		0.021REF.	
L1	0.460	0.150	0.018	0.006
L2	0.200	0.000	0.008	0.000
θ	8°	0°	8°	0°