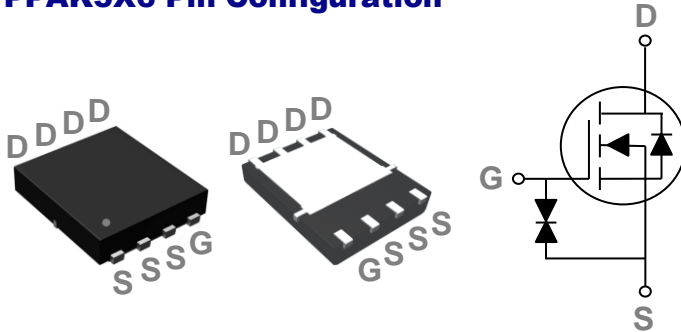


### General Description

These N-Channel enhancement mode power field effect transistors are using trench DMOS technology. This advanced technology has been especially tailored to minimize on-state resistance, provide superior switching performance, and withstand high energy pulse in the avalanche and commutation mode. These devices are well suited for high efficiency fast switching applications.

BVDSS	RDSON	ID
30V	6mΩ	60A

### PPAK5X6 Pin Configuration



### Features

- 30V,60A,  $R_{DS(ON)} = 6m\Omega @ V_{GS} = 10V$
- Improved  $dv/dt$  capability
- Fast switching
- 100% EAS Guaranteed
- Green Device Available
- 1.5kV HBM ESD Capability

### Applications

- MB / VGA / Vcore
- POL Applications
- SMPS 2<sup>nd</sup> SR

### Absolute Maximum Ratings $T_c=25^\circ C$ unless otherwise noted

Symbol	Parameter	Rating	Units
$V_{DS}$	Drain-Source Voltage	30	V
$V_{GS}$	Gate-Source Voltage	$\pm 20$	V
$I_D$	Drain Current – Continuous ( $T_c=25^\circ C$ )	60	A
	Drain Current – Continuous ( $T_c=100^\circ C$ )	38	A
$I_{DM}$	Drain Current – Pulsed <sup>1</sup>	240	A
EAS	Single Pulse Avalanche Energy <sup>2</sup>	45	mJ
IAS	Single Pulse Avalanche Current <sup>2</sup>	30	A
$P_D$	Power Dissipation ( $T_c=25^\circ C$ )	44	W
	Power Dissipation – Derate above $25^\circ C$	0.35	W/ $^\circ C$
$T_{STG}$	Storage Temperature Range	-55 to 150	$^\circ C$
$T_J$	Operating Junction Temperature Range	-55 to 150	$^\circ C$

### Thermal Characteristics

Symbol	Parameter	Typ.	Max.	Unit
$R_{\theta JA}$	Thermal Resistance Junction to ambient	---	62	$^\circ C/W$
$R_{\theta JC}$	Thermal Resistance Junction to Case	---	2.86	$^\circ C/W$

**Electrical Characteristics ( $T_J=25\text{ }^\circ\text{C}$ , unless otherwise noted)**
**Off Characteristics**

Symbol	Parameter	Conditions	Min.	Typ.	Max.	Unit
$BV_{DSS}$	Drain-Source Breakdown Voltage	$V_{GS}=0V, I_D=250\mu A$	30	---	---	V
$I_{DSS}$	Drain-Source Leakage Current	$V_{DS}=27V, V_{GS}=0V, T_J=25^\circ C$	---	---	1	$\mu A$
		$V_{DS}=24V, V_{GS}=0V, T_J=85^\circ C$	---	---	10	$\mu A$
$I_{GSS}$	Gate-Source Leakage Current	$V_{GS}=\pm 20V, V_{DS}=0V$	---	---	$\pm 20$	$\mu A$

**On Characteristics**

$R_{DS(ON)}$	Static Drain-Source On-Resistance	$V_{GS}=10V, I_D=20A$	---	5	6	$m\Omega$
		$V_{GS}=4.5V, I_D=15A$	---	8	11	$m\Omega$
$V_{GS(th)}$	Gate Threshold Voltage	$V_{GS}=V_{DS}, I_D=250\mu A$	1.2	1.6	2.5	V

**Dynamic and switching Characteristics<sup>3</sup>**

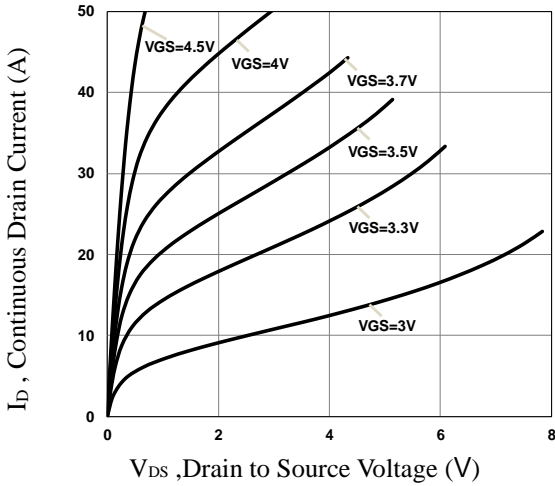
$Q_g$	Total Gate Charge	$V_{DS}=15V, V_{GS}=10V, I_D=30A$	---	13	25	nC
			---	6.3	12	
			---	1.1	3	
$Q_{gs}$	Gate-Source Charge	$V_{DS}=15V, V_{GS}=4.5V, I_D=30A$	---	2.2	5	ns
$Q_{gd}$	Gate-Drain Charge		---	3	6	
$T_{d(on)}$	Turn-On Delay Time		---	5	10	
$T_r$	Rise Time	$V_{DD}=15V, V_{GS}=10V, R_G=6\Omega, I_D=30A$	---	8	16	pF
$T_{d(off)}$	Turn-Off Delay Time		---	680	1400	
$T_f$	Fall Time		---	507	1000	
$C_{iss}$	Input Capacitance	$V_{DS}=15V, V_{GS}=0V, F=1MHz$	---	27	60	$\Omega$
$C_{oss}$	Output Capacitance		---	1.5	---	
$C_{rss}$	Reverse Transfer Capacitance		---	---	---	
$R_g$	Gate resistance	$V_{GS}=0V, V_{DS}=0V, F=1MHz$	---	---	---	

**Drain-Source Diode Characteristics and Maximum Ratings**

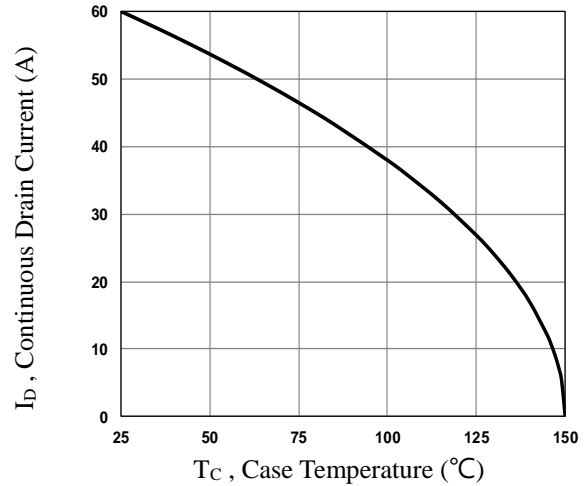
Symbol	Parameter	Conditions	Min.	Typ.	Max.	Unit
$I_S$	Continuous Source Current	$V_G=V_D=0V, \text{Force Current}$	---	---	60	A
$I_{SM}$	Pulsed Source Current		---	---	120	A
$V_{SD}$	Diode Forward Voltage	$V_{GS}=0V, I_S=1A, T_J=25^\circ C$	---	---	1	V

Note :

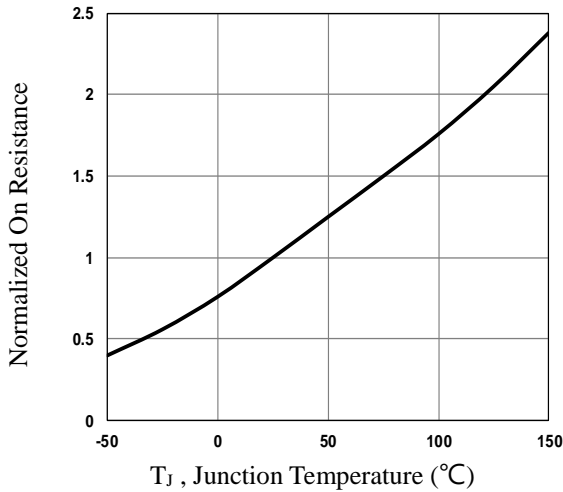
1. Repetitive Rating : Pulsed width limited by maximum junction temperature.
2.  $V_{DD}=25V, V_{GS}=10V, L=0.1mH, I_{AS}=30A, R_G=25\Omega, \text{Starting } T_J=25^\circ C$ .
3. Essentially independent of operating temperature.



**Fig.1 Typical Output Characteristics**



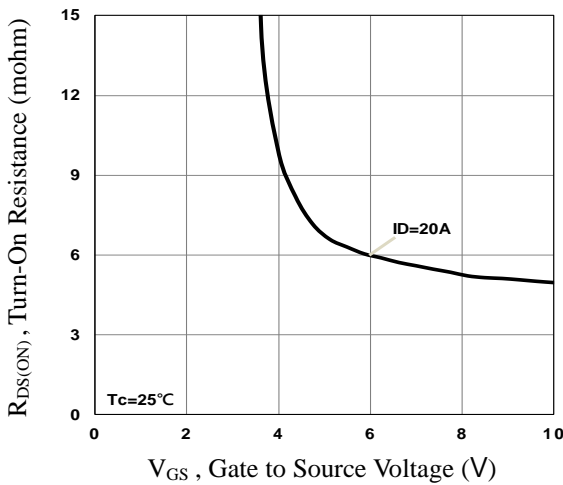
**Fig.2 Continuous Drain Current vs.  $T_c$**



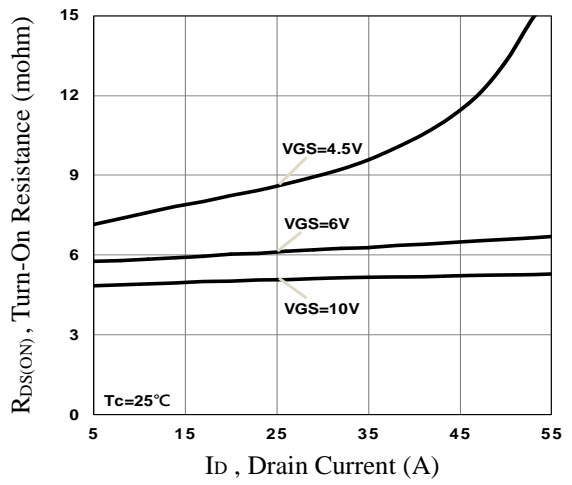
**Fig.3 Normalized  $R_{DS(on)}$  vs.  $T_j$**



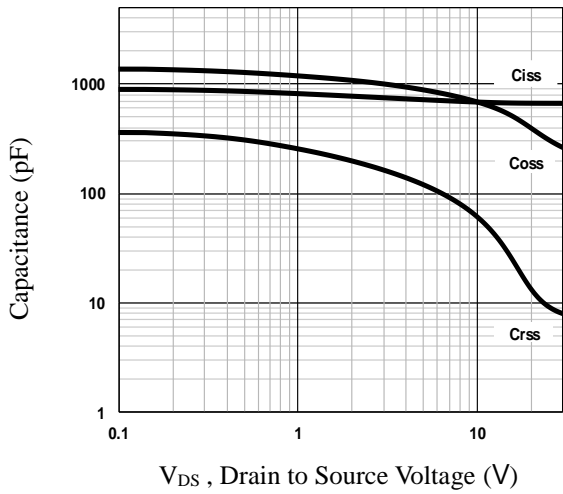
**Fig.4 Normalized  $V_{th}$  vs.  $T_j$**



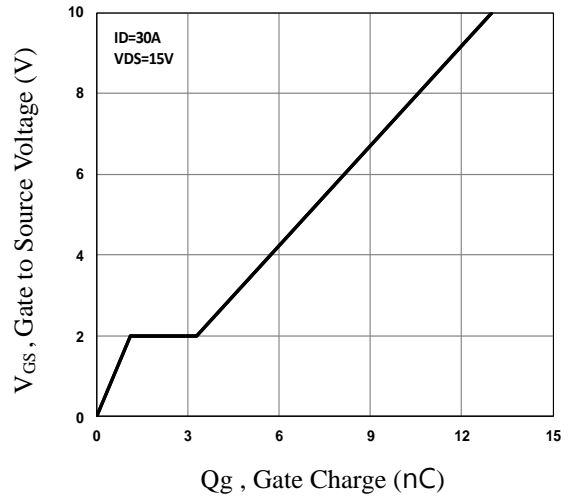
**Fig.5 Turn-On Resistance vs.  $V_{GS}$**



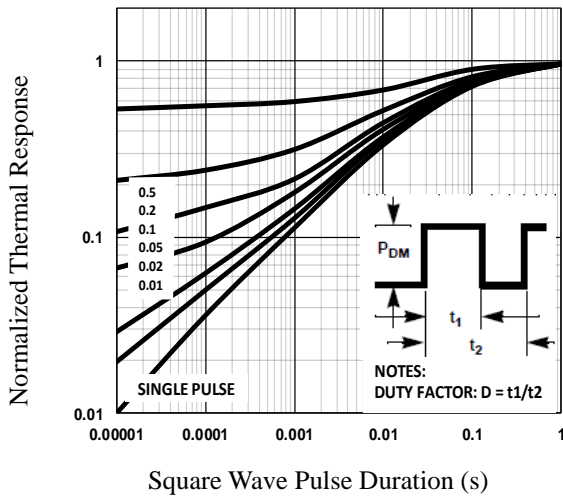
**Fig.6 Turn-On Resistance vs.  $I_D$**



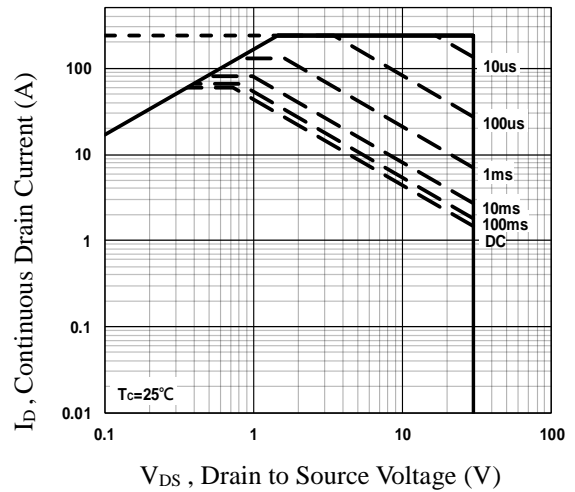
**Fig.7 Capacitance Characteristics**



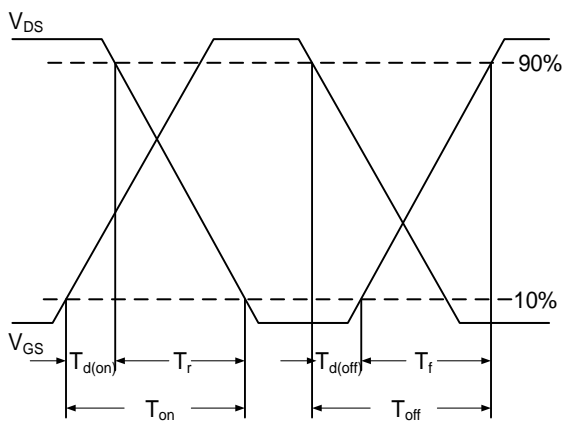
**Fig.8 Gate Charge Characteristics**



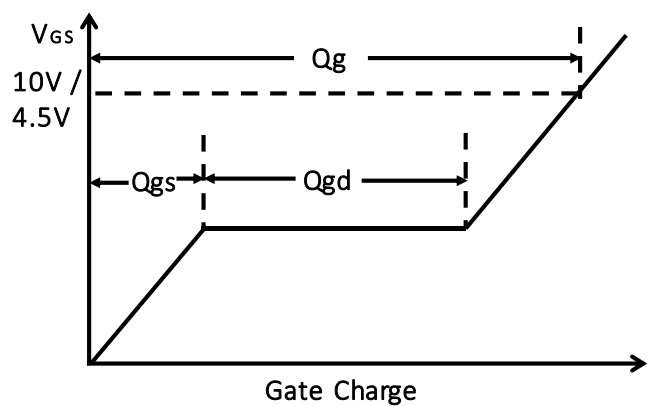
**Fig.9 Normalized Transient Impedance**



**Fig.10 Maximum Safe Operation Area**

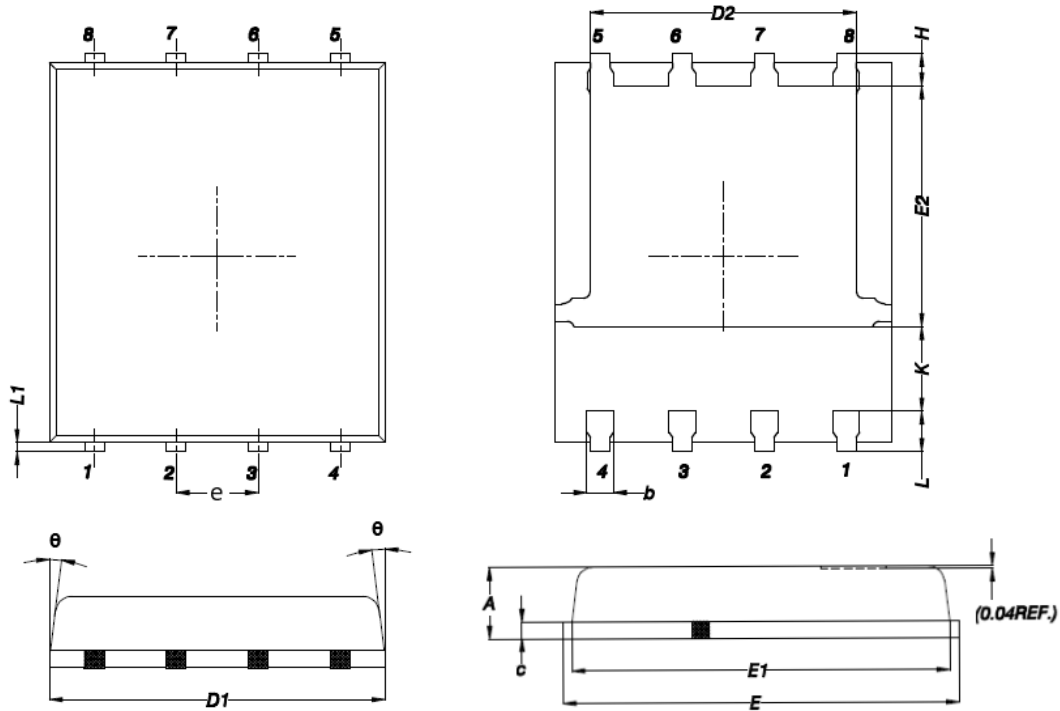


**Fig.11 Switching Time Waveform**



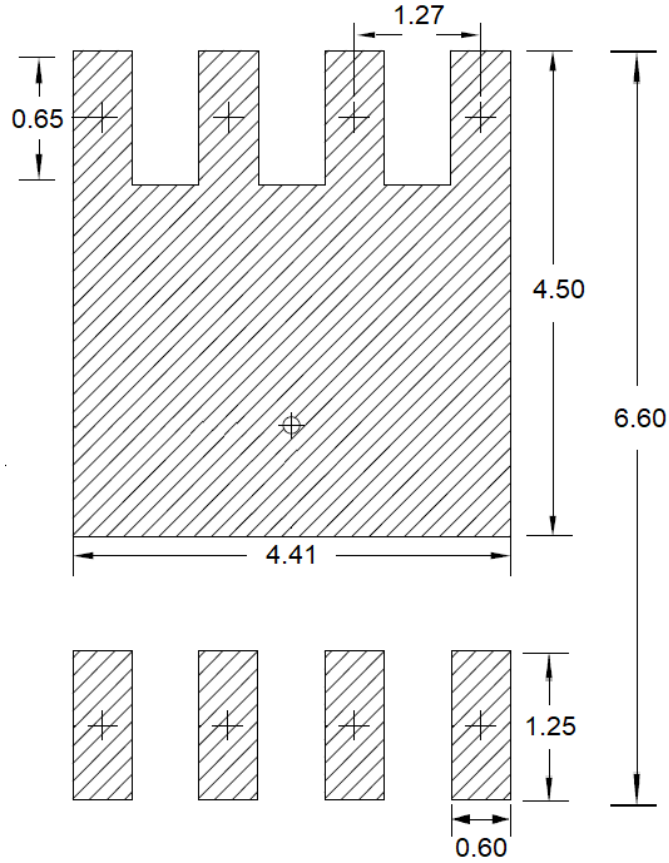
**Fig.12 Gate Charge Waveform**

## PPAK5x6 PACKAGE INFORMATION



Symbol	Dimensions In Millimeters		Dimensions In Inches	
	MAX	MIN	MAX	MIN
A	1.200	0.850	0.047	0.031
b	0.510	0.300	0.020	0.012
C	0.300	0.200	0.012	0.008
D1	5.400	4.800	0.212	0.189
D2	4.310	3.610	0.170	0.142
E	6.300	5.850	0.248	0.230
E1	5.960	5.450	0.235	0.215
E2	3.920	3.300	0.154	0.130
e	1.27BSC		0.05BSC	
H	0.650	0.380	0.026	0.015
K	---	1.100	---	0.043
L	0.710	0.380	0.028	0.015
L1	0.250	0.050	0.009	0.002
theta	12°	0°	12°	0°

### PPAK5X6 RECOMMENDED LAND PATTERN



unit : mm