

General Description

These N-Channel enhancement mode power field effect transistors are using trench DMOS technology. This advanced technology has been especially tailored to minimize on-state resistance, provide superior switching performance, and withstand high energy pulse in the avalanche and commutation mode. These devices are well suited for high efficiency fast switching applications.

BVDSS	R _{DS(ON)}	I _D
65V	16mΩ	35A

Features

- 65V,35A, R_{DS(ON)} =16mΩ @V_{GS} = 10V
- Improved dv/dt capability
- Fast switching
- 100% EAS Guaranteed
- Green Device Available

PPAK3X3 Pin Configuration

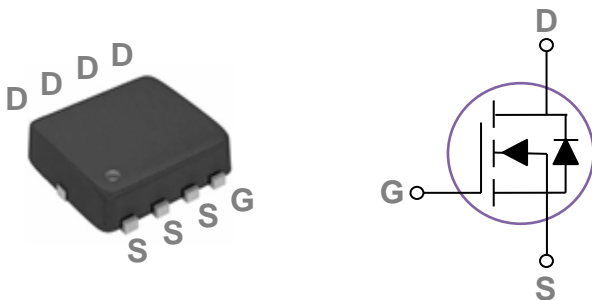

Applications

- Motor Drive
- Power Tools
- LED Lighting
- Quick Charger

Absolute Maximum Ratings T_C=25°C unless otherwise noted

Symbol	Parameter	Rating	Units
V _{DS}	Drain-Source Voltage	65	V
V _{GS}	Gate-Source Voltage	+20/-12	V
I _D	Drain Current – Continuous (T _C =25°C)	35	A
	Drain Current – Continuous (T _C =100°C)	22	A
I _{DM}	Drain Current – Pulsed ¹	140	A
EAS	Single Pulse Avalanche Energy ²	9.1	mJ
IAS	Single Pulse Avalanched Current ²	13.5	A
P _D	Power Dissipation (T _C =25°C)	33.8	W
	Power Dissipation – Derate above 25°C	0.27	W/°C
T _{STG}	Storage Temperature Range	-55 to 150	°C
T _J	Operating Junction Temperature Range	-55 to 150	°C

Thermal Characteristics

Symbol	Parameter	Typ.	Max.	Unit
R _{θJA}	Thermal Resistance Junction to ambient	---	62	°C/W
R _{θJC}	Thermal Resistance Junction to Case	---	3.7	°C/W

Electrical Characteristics ($T_J=25\text{ }^\circ\text{C}$, unless otherwise noted)
Off Characteristics

Symbol	Parameter	Conditions	Min.	Typ.	Max.	Unit
BV_{DSS}	Drain-Source Breakdown Voltage	$V_{GS}=0V, I_D=250\mu A$	65	---	---	V
$\Delta BV_{DSS}/\Delta T_J$	BV_{DSS} Temperature Coefficient	Reference to 25°C , $I_D=1\text{mA}$	---	0.03	---	$V/^\circ\text{C}$
I_{DSS}	Drain-Source Leakage Current	$V_{DS}=60V, V_{GS}=0V, T_J=25^\circ\text{C}$	---	---	1	μA
		$V_{DS}=48V, V_{GS}=0V, T_J=85^\circ\text{C}$	---	---	10	μA
I_{GSS}	Gate-Source Leakage Current	$V_{GS}=+20V, V_{DS}=0V$	---	---	100	nA

On Characteristics

$R_{DS(ON)}$	Static Drain-Source On-Resistance ³	$V_{GS}=10V, I_D=12A$	---	12.6	16	$m\Omega$
		$V_{GS}=4.5V, I_D=5A$	---	23	30	$m\Omega$
$V_{GS(th)}$	Gate Threshold Voltage	$V_{GS}=V_{DS}, I_D=250\mu A$	1	1.6	2.5	V
$\Delta V_{GS(th)}$	$V_{GS(th)}$ Temperature Coefficient		---	-5.1	---	$mV/^\circ\text{C}$
g_{fs}	Forward Transconductance	$V_{DS}=10V, I_D=3A$	---	5	---	S

Dynamic and switching Characteristics

Q_g	Total Gate Charge ^{3, 4}	$V_{DS}=30V, V_{GS}=10V, I_D=12A$	---	10.9	22	nC
Q_{gs}	Gate-Source Charge ^{3, 4}		---	1.5	3	
Q_{gd}	Gate-Drain Charge ^{3, 4}		---	4.4	9	
$T_{d(on)}$	Turn-On Delay Time ^{3, 4}	$V_{DD}=30V, V_{GS}=10V, R_G=3.3\Omega$ $I_D=1A$	---	8	16	ns
T_r	Rise Time ^{3, 4}		---	12	24	
$T_{d(off)}$	Turn-Off Delay Time ^{3, 4}		---	25	50	
T_f	Fall Time ^{3, 4}		---	18	36	
C_{iss}	Input Capacitance	$V_{DS}=30V, V_{GS}=0V, F=1\text{MHz}$	---	653	1300	pF
C_{oss}	Output Capacitance		---	192	380	
C_{rss}	Reverse Transfer Capacitance		---	27	60	
R_g	Gate resistance	$V_{GS}=0V, V_{DS}=0V, F=1\text{MHz}$	---	0.3	---	Ω

Drain-Source Diode Characteristics and Maximum Ratings

Symbol	Parameter	Conditions	Min.	Typ.	Max.	Unit
I_S	Continuous Source Current	$V_G=V_D=0V$, Force Current	---	---	35	A
I_{SM}	Pulsed Source Current ³		---	---	70	A
V_{SD}	Diode Forward Voltage ³	$V_{GS}=0V, I_S=1A, T_J=25^\circ\text{C}$	---	---	1	V

Note :

1. Repetitive Rating : Pulsed width limited by maximum junction temperature.
2. $V_{DD}=50V, V_{GS}=10V, L=0.1\text{mH}, I_{AS}=13.5A, R_G=25\Omega$, Starting $T_J=25^\circ\text{C}$.
3. The data tested by pulsed , pulse width $\leq 300\mu s$, duty cycle $\leq 2\%$.
4. Essentially independent of operating temperature.

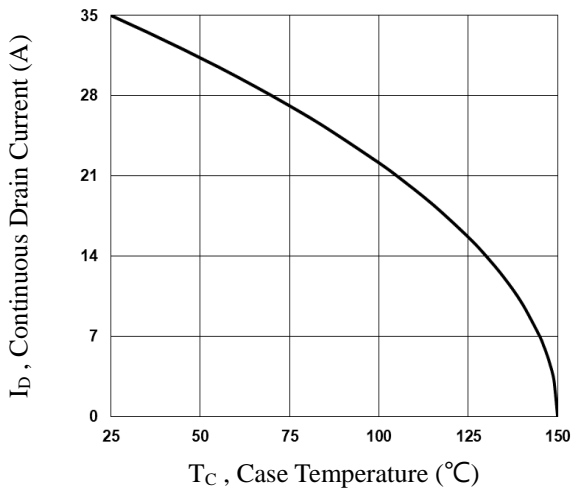

Fig.1 Continuous Drain Current vs. T_c

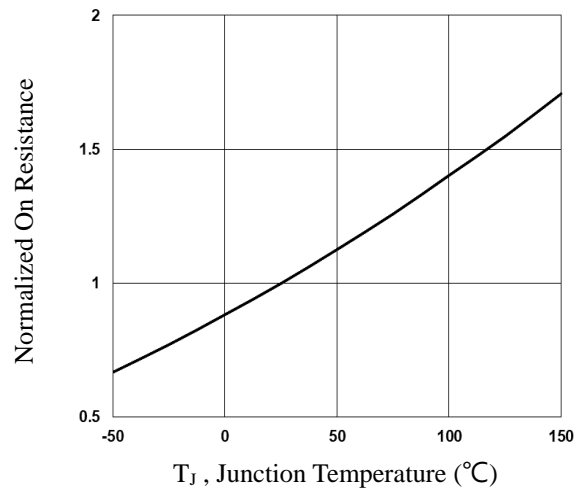

Fig.2 Normalized $R_{DS(on)}$ vs. T_j

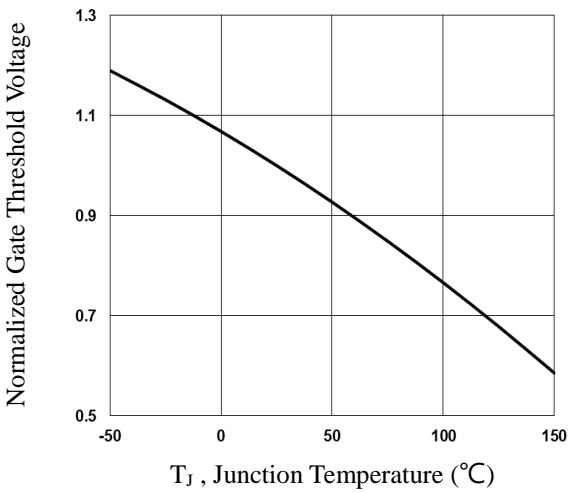

Fig.3 Normalized V_{th} vs. T_j

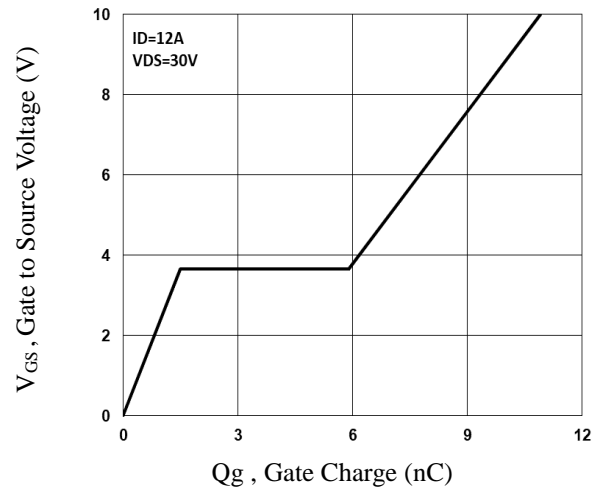

Fig.4 Gate Charge Waveform

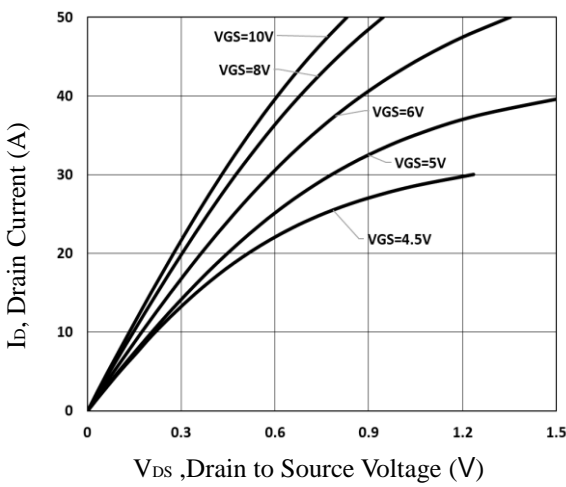

Fig.5 Typical Output Characteristics

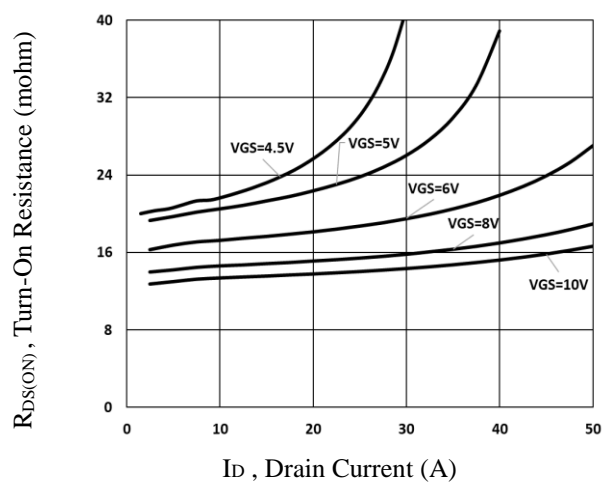

Fig.6 Turn-On Resistance vs. I_D

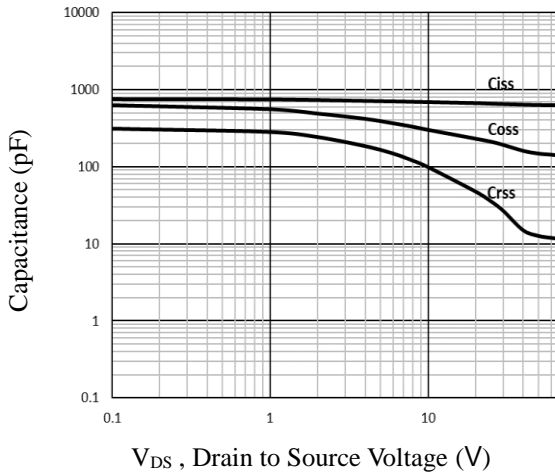

Fig.7 Capacitance Characteristics

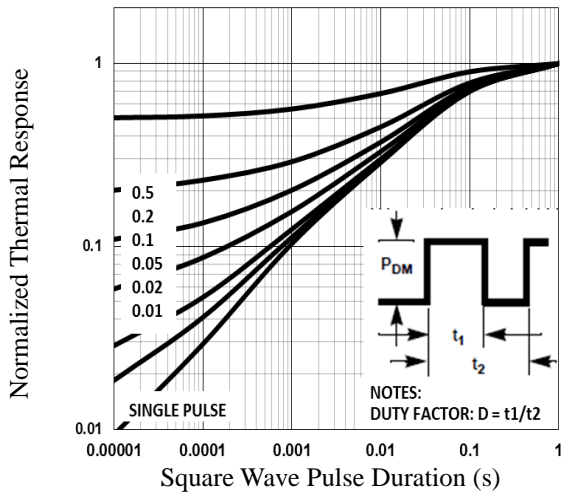

Fig.8 Normalized Transient Response

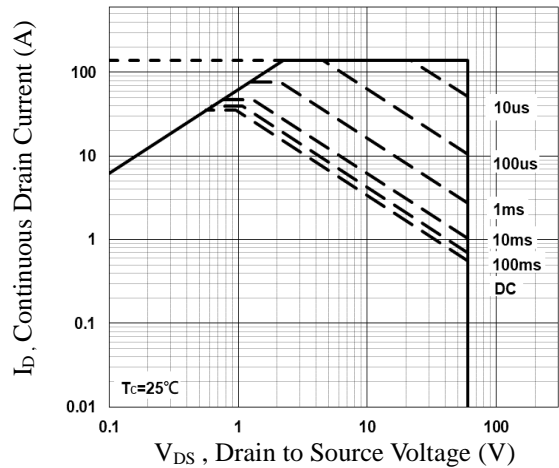

Fig.9 Maximum Safe Operation Area

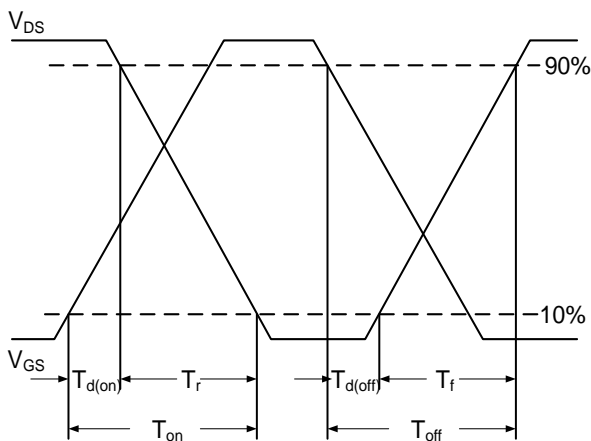

Fig.10 Switching Time Waveform

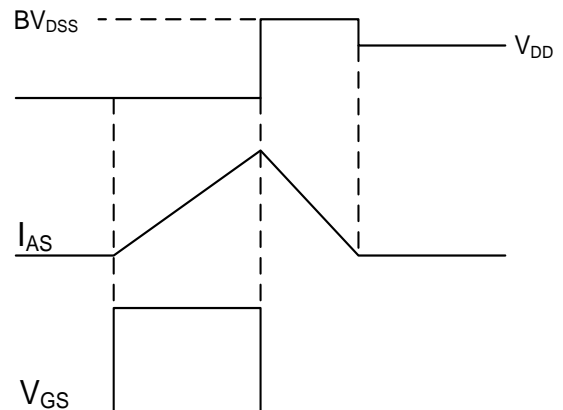

Fig.11 EAS Waveform

PPAK3x3 PACKAGE INFORMATION



Symbol	Dimensions In Millimeters		Dimensions In Inches	
	MAX	MIN	MAX	MIN
A	0.900	0.700	0.035	0.028
b	0.350	0.250	0.014	0.010
c	0.250	0.100	0.010	0.004
D	3.500	3.050	0.138	0.120
D1	3.200	2.900	0.126	0.114
D2	1.950	1.350	0.077	0.053
E	3.400	3.000	0.134	0.118
E1	3.300	2.900	0.130	0.114
E2	2.600	2.350	0.102	0.093
e	0.65BSC		0.026BSC	
H	0.750	0.300	0.030	0.012
L	0.600	0.300	0.024	0.012
L1	0.200	0.060	0.008	0.002
θ	14°	6°	14°	6°

PPAK3X3 RECOMMENDED LAND PATTERN

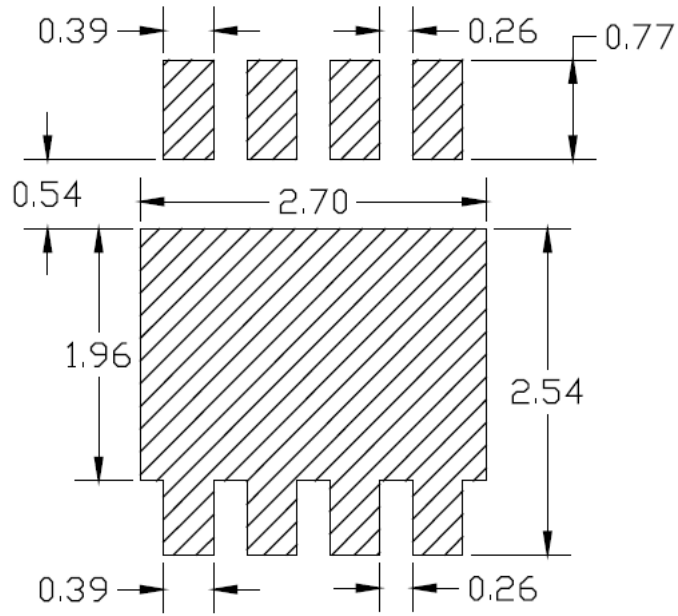

unit : mm