

### General Description

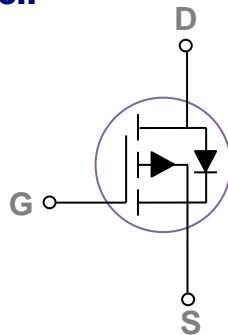
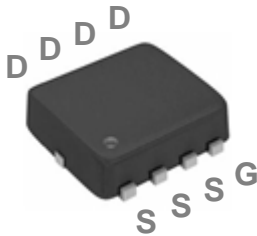
These P-Channel enhancement mode power field effect transistors are using trench DMOS technology. This advanced technology has been especially tailored to minimize on-state resistance, provide superior switching performance, and withstand high energy pulse in the avalanche and commutation mode. These devices are well suited for high efficiency fast switching applications.

BVDSS	RDSON	ID
-60V	65mΩ	-14A

### Features

- -60V,-14A,  $R_{DS(ON)} = 65m\Omega @ V_{GS} = -10V$
- Improved dv/dt capability
- Fast switching
- 100% EAS Guaranteed
- Green Device Available

### PPAK3X3 Pin Configuration



### Applications

- Motor Drive
- Power Tools
- LED Lighting

### Absolute Maximum Ratings $T_c=25^\circ\text{C}$ unless otherwise noted

Symbol	Parameter	Rating	Units
$V_{DS}$	Drain-Source Voltage	-60	V
$V_{GS}$	Gate-Source Voltage	$\pm 20$	V
$I_D$	Drain Current – Continuous ( $T_c=25^\circ\text{C}$ )	-14	A
	Drain Current – Continuous ( $T_c=100^\circ\text{C}$ )	-8.9	A
$I_{DM}$	Drain Current – Pulsed <sup>1</sup>	-56	A
EAS	Single Pulse Avalanche Energy <sup>2</sup>	31	mJ
IAS	Single Pulse Avalanche Current <sup>2</sup>	-25	A
$P_D$	Power Dissipation ( $T_c=25^\circ\text{C}$ )	33.8	W
	Power Dissipation – Derate above $25^\circ\text{C}$	0.27	W/ $^\circ\text{C}$
$T_{STG}$	Storage Temperature Range	-55 to 150	$^\circ\text{C}$
$T_J$	Operating Junction Temperature Range	-55 to 150	$^\circ\text{C}$

### Thermal Characteristics

Symbol	Parameter	Typ.	Max.	Unit
$R_{\theta JA}$	Thermal Resistance Junction to ambient	---	62	$^\circ\text{C/W}$
$R_{\theta JC}$	Thermal Resistance Junction to Case	---	3.7	$^\circ\text{C/W}$

**Electrical Characteristics ( $T_J=25^\circ\text{C}$ , unless otherwise noted)**
**Off Characteristics**

Symbol	Parameter	Conditions	Min.	Typ.	Max.	Unit
$BV_{DSS}$	Drain-Source Breakdown Voltage	$V_{GS}=0V, I_D=-250\mu A$	-60	---	---	V
$\Delta BV_{DSS}/\Delta T_J$	$BV_{DSS}$ Temperature Coefficient	Reference to $25^\circ\text{C}$ , $I_D=-1\text{mA}$	---	-0.05	---	$V/^\circ\text{C}$
$I_{DSS}$	Drain-Source Leakage Current	$V_{DS}=-60V, V_{GS}=0V, T_J=25^\circ\text{C}$	---	---	-1	$\mu A$
		$V_{DS}=-48V, V_{GS}=0V, T_J=125^\circ\text{C}$	---	---	-10	$\mu A$
$I_{GSS}$	Gate-Source Leakage Current	$V_{GS}=\pm 20V, V_{DS}=0V$	---	---	$\pm 100$	nA

**On Characteristics**

$R_{DS(ON)}$	Static Drain-Source On-Resistance	$V_{GS}=-10V, I_D=-8A$	---	54	65	$m\Omega$
		$V_{GS}=-4.5V, I_D=-6A$	---	70	90	$m\Omega$
$V_{GS(th)}$	Gate Threshold Voltage	$V_{GS}=V_{DS}, I_D=-250\mu A$	-1.2	-1.6	-2.2	V
$\Delta V_{GS(th)}$	$V_{GS(th)}$ Temperature Coefficient		---	5	---	$mV/^\circ\text{C}$
gfs	Forward Transconductance	$V_{DS}=-10V, I_D=-3A$	---	7	---	S

**Dynamic and switching Characteristics**

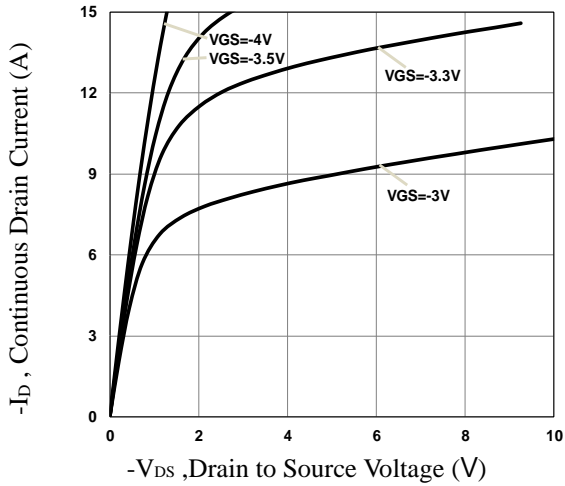
$Q_g$	Total Gate Charge <sup>3, 4</sup>	$V_{DS}=-30V, V_{GS}=-10V, I_D=-3A$	---	16.4	23	nC
$Q_{gs}$	Gate-Source Charge <sup>3, 4</sup>		---	2.8	4	
$Q_{gd}$	Gate-Drain Charge <sup>3, 4</sup>		---	3.6	6	
$T_{d(on)}$	Turn-On Delay Time <sup>3, 4</sup>	$V_{DD}=-30V, V_{GS}=-10V, R_G=6\Omega$ $I_D=-1A$	---	8.3	16	ns
$T_r$	Rise Time <sup>3, 4</sup>		---	29.6	56	
$T_{d(off)}$	Turn-Off Delay Time <sup>3, 4</sup>		---	51.7	98	
$T_f$	Fall Time <sup>3, 4</sup>		---	15.6	30	
$C_{iss}$	Input Capacitance	$V_{DS}=-30V, V_{GS}=0V, F=1\text{MHz}$	---	870	1260	pF
$C_{oss}$	Output Capacitance		---	70	100	
$C_{rss}$	Reverse Transfer Capacitance		---	42	60	
$R_g$	Gate resistance		$V_{GS}=0V, V_{DS}=0V, F=1\text{MHz}$	---	16	

**Drain-Source Diode Characteristics and Maximum Ratings**

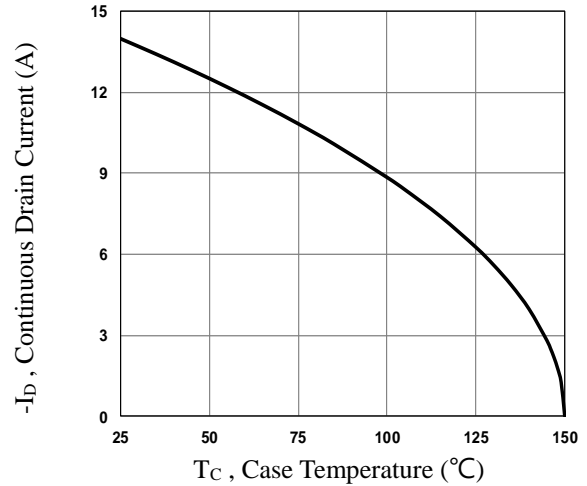
Symbol	Parameter	Conditions	Min.	Typ.	Max.	Unit
$I_S$	Continuous Source Current	$V_G=V_D=0V$ , Force Current	---	---	-14	A
$I_{SM}$	Pulsed Source Current		---	---	-28	A
$V_{SD}$	Diode Forward Voltage	$V_{GS}=0V, I_S=-1A, T_J=25^\circ\text{C}$	---	---	-1	V

Note :

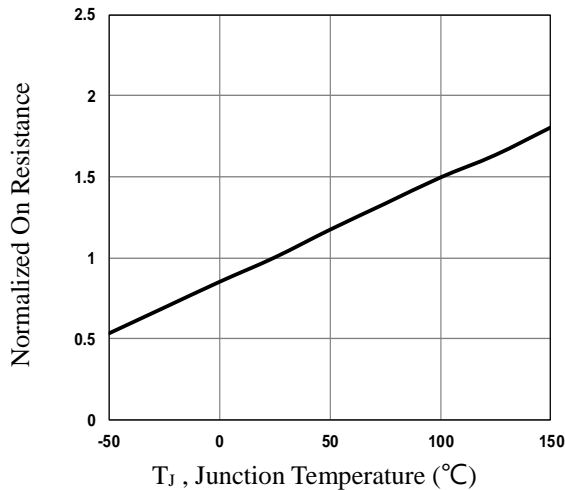
1. Repetitive Rating : Pulsed width limited by maximum junction temperature.
2.  $V_{DD}=-25V, V_{GS}=-10V, L=0.1\text{mH}, I_{AS}=-25A., R_G=25\Omega$ , Starting  $T_J=25^\circ\text{C}$ .
3. The data tested by pulsed , pulse width  $\leq 300\mu s$ , duty cycle  $\leq 2\%$ .
4. Essentially independent of operating temperature.



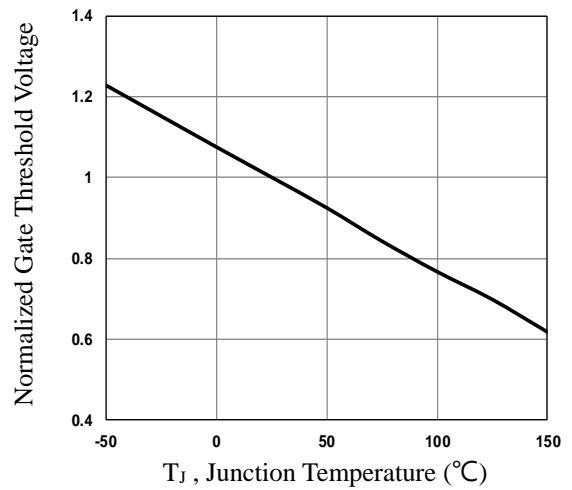
**Fig.1 Typical Output Characteristics**



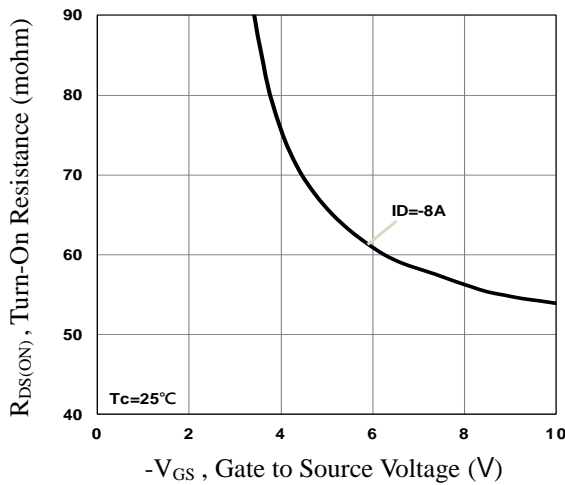
**Fig.2 Continuous Drain Current vs. T<sub>C</sub>**



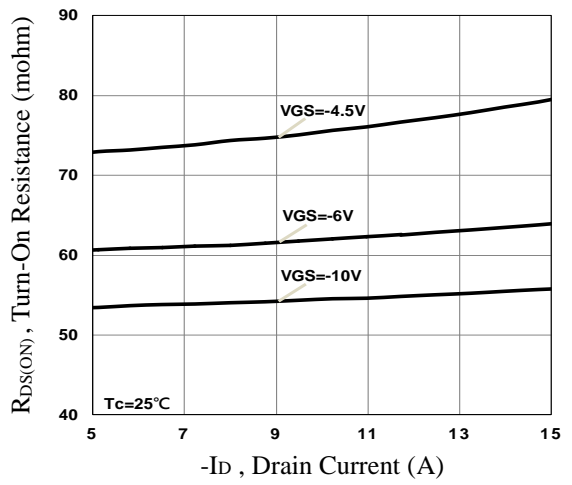
**Fig.3 Normalized R<sub>DS(on)</sub> vs. T<sub>J</sub>**



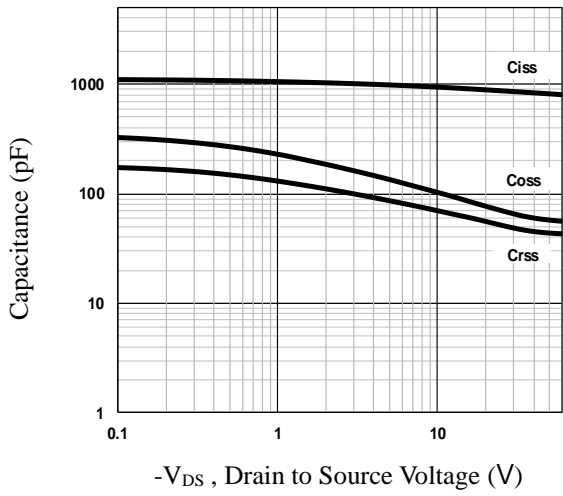
**Fig.4 Normalized V<sub>th</sub> vs. T<sub>J</sub>**



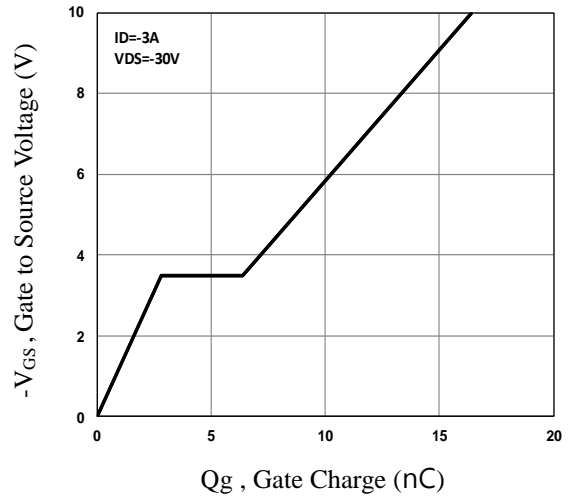
**Fig.5 Turn-On Resistance vs. V<sub>GS</sub>**



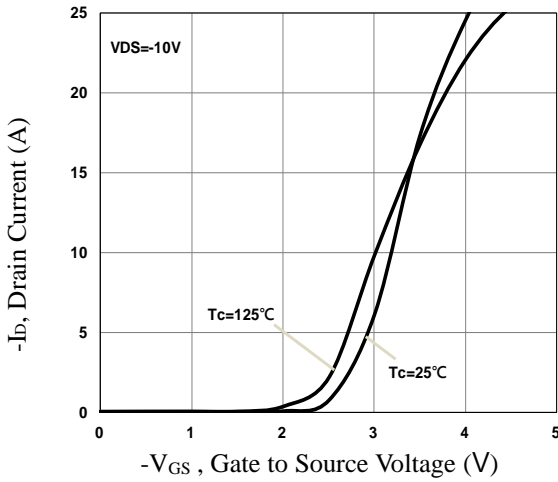
**Fig.6 Turn-On Resistance vs. I<sub>D</sub>**



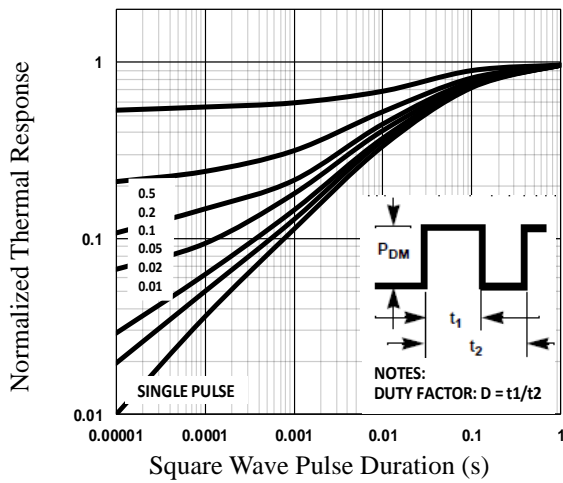
**Fig.7 Capacitance Characteristics**



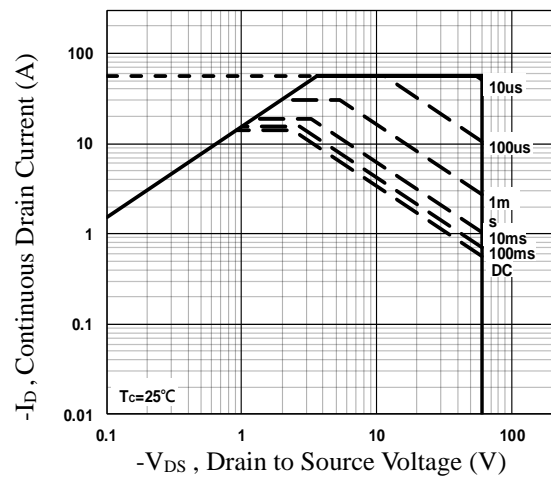
**Fig.8 Gate Charge Characteristics**



**Fig.9 Transfer Characteristics**

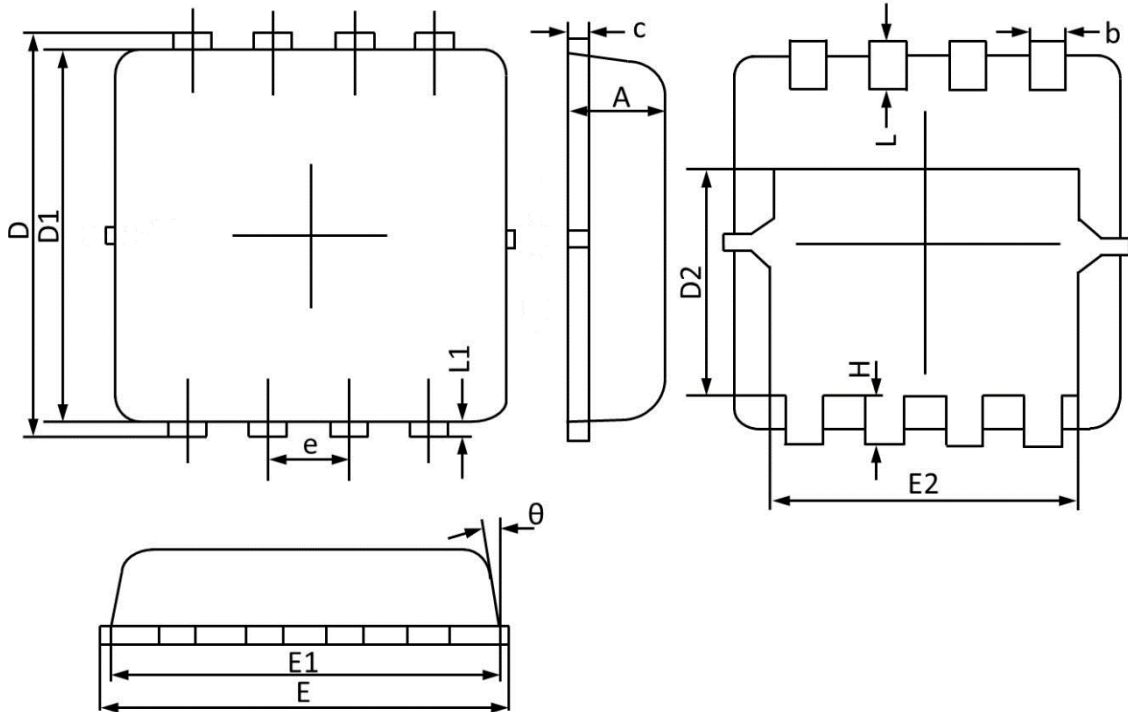


**Fig.10 Normalized Transient Impedance**



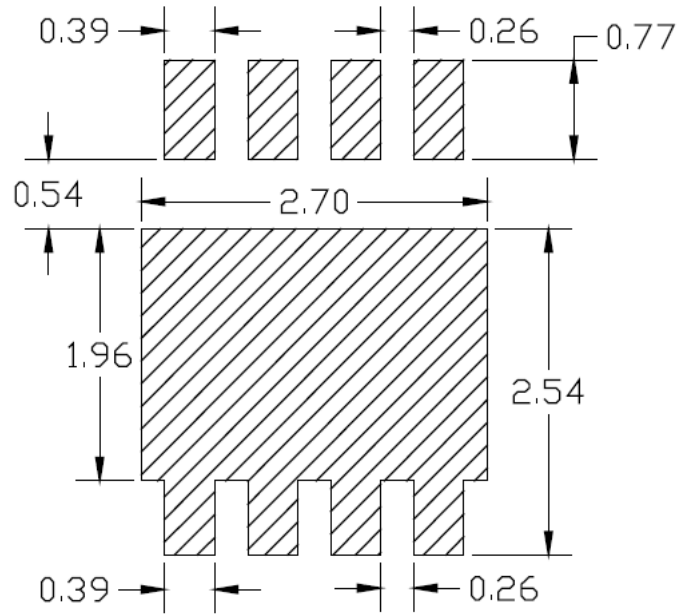
**Fig.11 Maximum Safe Operation Area**

**PPAK3x3 PACKAGE INFORMATION**



Symbol	Dimensions In Millimeters		Dimensions In Inches	
	MAX	MIN	MAX	MIN
A	0.900	0.700	0.035	0.028
b	0.350	0.250	0.014	0.010
c	0.250	0.100	0.010	0.004
D	3.500	3.050	0.138	0.120
D1	3.200	2.900	0.126	0.114
D2	1.950	1.350	0.077	0.053
E	3.400	3.000	0.134	0.118
E1	3.300	2.900	0.130	0.114
E2	2.600	2.350	0.102	0.093
e	0.65BSC		0.026BSC	
H	0.750	0.300	0.030	0.012
L	0.600	0.300	0.024	0.012
L1	0.200	0.060	0.008	0.002
θ	14°	6°	14°	6°

### PPAK3X3 RECOMMENDED LAND PATTERN



unit : mm