

General Description

These N-Channel enhancement mode power field effect transistors are using trench DMOS technology. This advanced technology has been especially tailored to minimize on-state resistance, provide superior switching performance, and withstand high energy pulse in the avalanche and commutation mode. These devices are well suited for high efficiency fast switching applications.

	BVDSS	RDSON	ID
Q1	30V	6.5mΩ	35A
Q2	30V	2.6mΩ	85A

Features

- Improved dv/dt capability
- Fast switching
- 100% EAS Guaranteed
- Green Device Available

PPAK5x6 Asymmetric Dual Pin Configuration

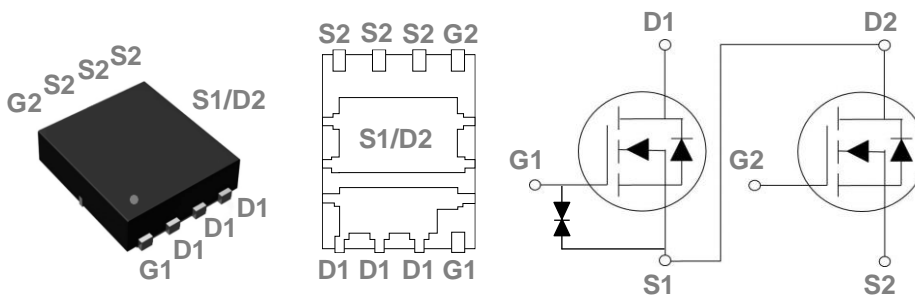

Applications

- MB / VGA / Vcore
- POL Buck Applications
- SMPS 2nd SR

Absolute Maximum Ratings $T_c=25^\circ\text{C}$ unless otherwise noted

Symbol	Parameter	Q1	Q2	Units
V_{DS}	Drain-Source Voltage	30	30	V
V_{GS}	Gate-Source Voltage	± 20	± 12	V
I_D	Drain Current – Continuous ($T_c=25^\circ\text{C}$)	35	85	A
	Drain Current – Continuous ($T_c=100^\circ\text{C}$)	22	54	A
I_{DM}	Drain Current – Pulsed ¹	140	340	A
EAS	Single Pulse Avalanche Energy ²	45	140	mJ
IAS	Single Pulse Avalanche Current ²	30	53	A
P_D	Power Dissipation ($T_c=25^\circ\text{C}$)	16	33	W
	Power Dissipation – Derate above 25°C	0.13	0.26	W/ $^\circ\text{C}$
T_{STG}	Storage Temperature Range	-55 to 150		$^\circ\text{C}$
T_J	Operating Junction Temperature Range	-55 to 150		$^\circ\text{C}$

Thermal Characteristics

Symbol	Parameter	Typ.	Max.	Unit
$R_{\theta JA}$ Q1	Thermal Resistance Junction to ambient ($t \leq 10\text{s}$)	---	40	$^\circ\text{C/W}$
$R_{\theta JA}$ Q2		---	40	$^\circ\text{C/W}$
$R_{\theta JC}$ Q1	Thermal Resistance Junction to Case	---	7.9	$^\circ\text{C/W}$
$R_{\theta JC}$ Q2		---	3.8	$^\circ\text{C/W}$

Electrical Characteristics ($T_J=25\text{ }^\circ\text{C}$, unless otherwise noted)
Static State Characteristics

Symbol	Parameter	Conditions		Min.	Typ.	Max.	Unit
BV _{DSS}	Drain-Source Breakdown Voltage	V _{GS} =0V, I _D =250μA	Q1	30	---	---	V
			Q2	30	---	---	V
I _{DSS}	Drain-Source Leakage Current	V _{DS} =27V, V _{GS} =0V, T _J =25°C	Q1	---	---	1	μA
			Q2	---	---	1	μA
		V _{DS} =24V, V _{GS} =0V, T _J =85°C	Q1	---	---	10	μA
			Q2	---	---	10	μA
I _{GSS}	Gate-Source Leakage Current	V _{GS} =±20V, V _{DS} =0V	Q1	---	---	±20	μA
		V _{GS} =12V, V _{DS} =0V	Q2	---	---	100	nA
R _{DS(ON)}	Static Drain-Source On-Resistance ³	V _{GS} =10V, I _D =20A	Q1	---	5.4	6.5	mΩ
		V _{GS} =10V, I _D =20A	Q2	---	2.1	2.6	mΩ
		V _{GS} =4.5V, I _D =15A	Q1	---	8.5	11	mΩ
		V _{GS} =4.5V, I _D =15A	Q2	---	2.5	3.3	mΩ
V _{GS(th)}	Gate Threshold Voltage	V _{GS} =V _{DS} , I _D =250μA	Q1	1.2	1.6	2.5	V
			Q2	0.9	1.3	1.7	V

Dynamic Characteristics³

Q _g	Total Gate Charge	V _{DS} =15V, V _{GS} =4.5V, I _D =20A	Q1	---	6.3	---	nC		
			Q2	---	22	---			
Q _g	Total Gate Charge	V _{DS} =15V, V _{GS} =10V, I _D =20A	Q1	---	13	---			
			Q2	---	45.5	---			
Q _{gs}	Gate-Source Charge		Q1	---	1.1	---			
			Q2	---	3.2	---			
Q _{gd}	Gate-Drain Charge		Q1	---	2.2	---			
			Q2	---	6	---			
T _{d(on)}	Turn-On Delay Time		V _{DD} =15V, V _{GS} =10V, R _G =6Ω I _D =20A	Q1	---	2.5		---	ns
				Q2	---	4		---	
T _r	Rise Time			Q1	---	3	---		
				Q2	---	6	---		
T _{d(off)}	Turn-Off Delay Time	Q1		---	5	---			
		Q2		---	12	---			
T _f	Fall Time	Q1		---	8	---			
		Q2		---	18	---			

C _{iss}	Input Capacitance	V _{DS} =15V , V _{GS} =0V , F=1MHz	Q1	---	680	---	pF
			Q2	---	2390	---	
C _{oss}	Output Capacitance		Q1	---	507	---	
			Q2	---	1050	---	
C _{rss}	Reverse Transfer Capacitance		Q1	---	27	---	
			Q2	---	62	---	
R _g	Gate resistance	V _{GS} =0V, V _{DS} =0V, F=1MHz	Q1	---	1.5	---	Ω
			Q2	---	1	---	Ω

Drain-Source Diode Characteristics

Symbol	Parameter	Conditions	Min.	Typ.	Max.	Unit		
I _S	Continuous Source Current	V _G =V _D =0V , Force Current	Q1	---	---	35	A	
			Q2	---	---	85	A	
I _{SM}	Pulsed Source Current ³		Q1	---	---	70	A	
			Q2	---	---	170	A	
V _{SD}	Diode Forward Voltage ³		V _{GS} =0V , I _S =1A , T _J =25°C	Q1	---	---	1	V
				Q2	---	---	1	V

Note :

1. Repetitive Rating : Pulsed width limited by maximum junction temperature.
2. V_{DD}=25V, V_{GS}=10V, L=0.1mH, Q1: I_{AS}=30A, Q2: I_{AS}=53A, R_G=25Ω, Starting T_J=25°C.
3. Essentially independent of operating temperature.

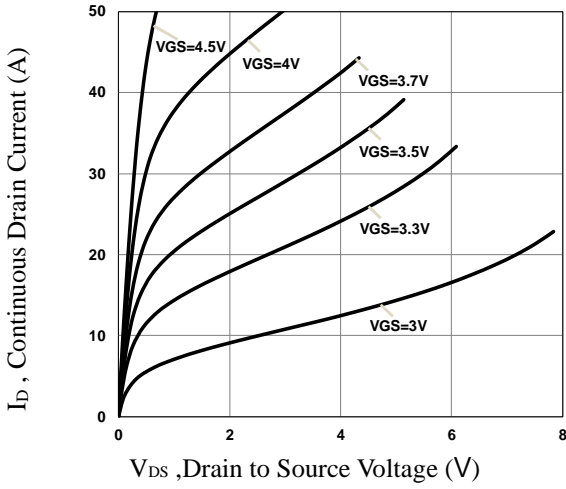

Fig.1 Q1 Typical Output Characteristics

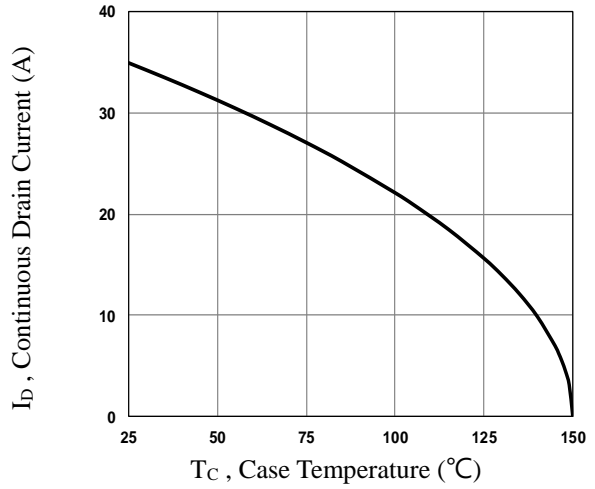

Fig.2 Q1 Continuous Drain Current vs. T_C

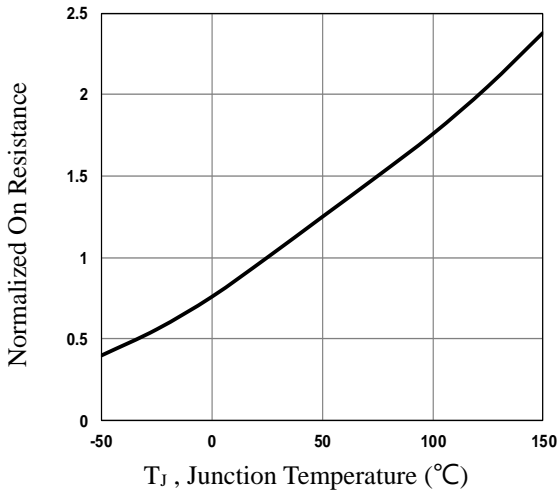

Fig.3 Q1 Normalized $R_{DS(on)}$ vs. T_J

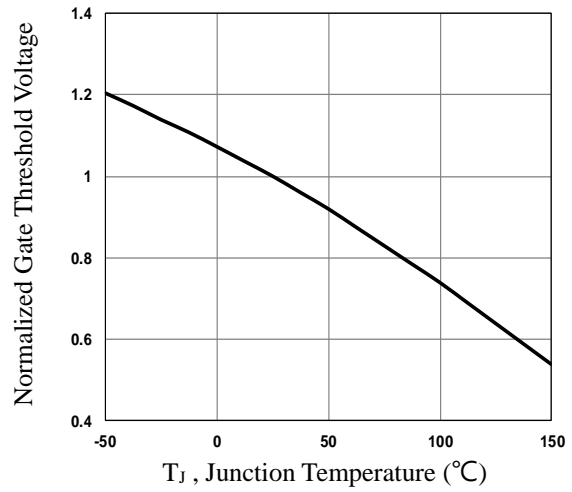

Fig.4 Q1 Normalized V_{th} vs. T_J

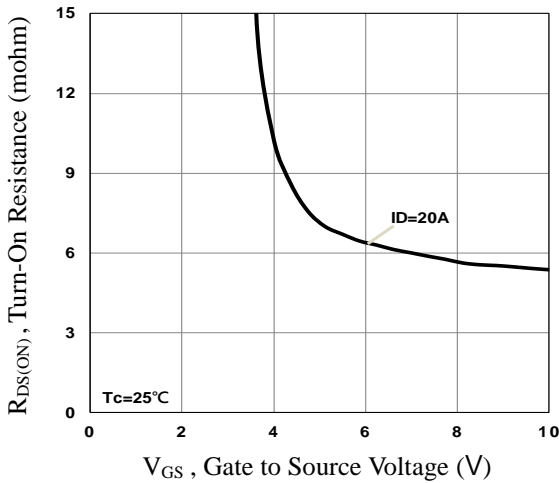

Fig.5 Q1 Turn-On Resistance vs. V_{GS}

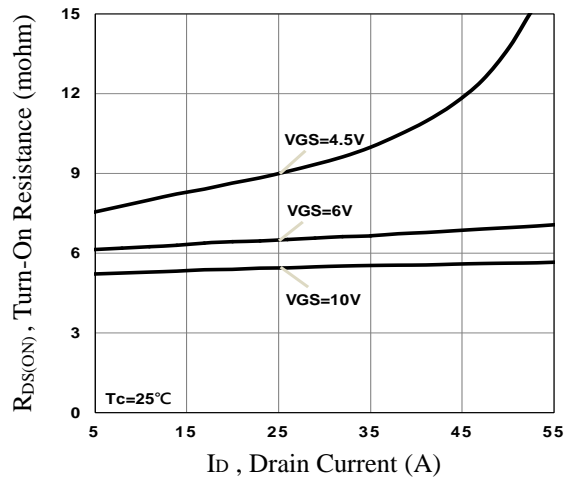

Fig.6 Q1 Turn-On Resistance vs. I_D

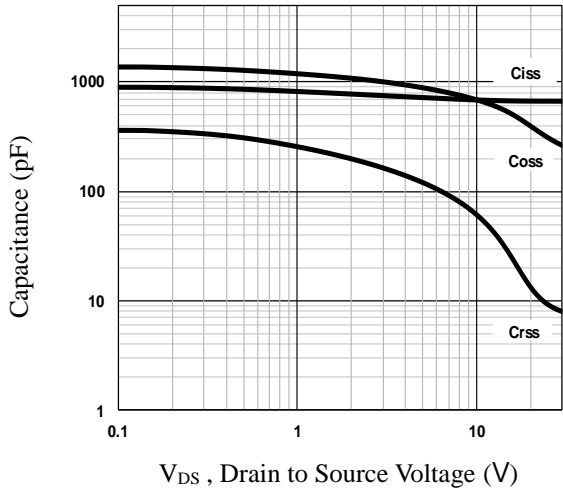

Fig.7 Q1 Capacitance Characteristics

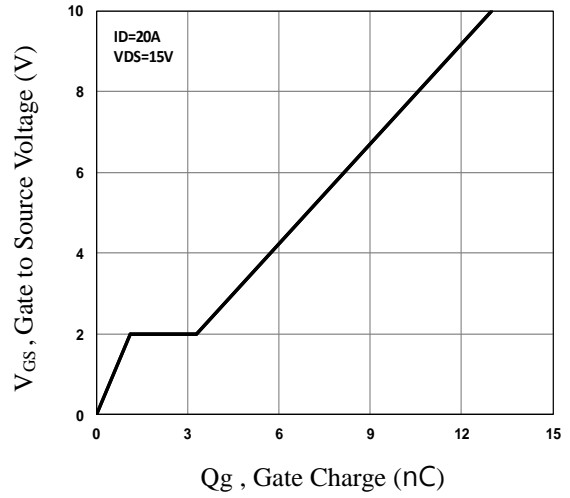

Fig.8 Q1 Gate Charge Characteristics

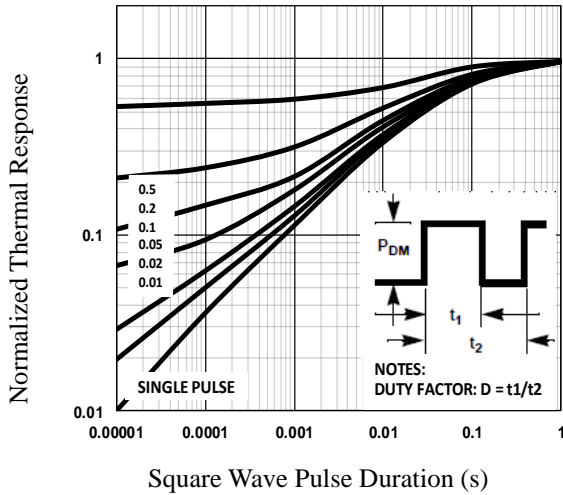

Fig.9 Q1 Normalized Transient Impedance

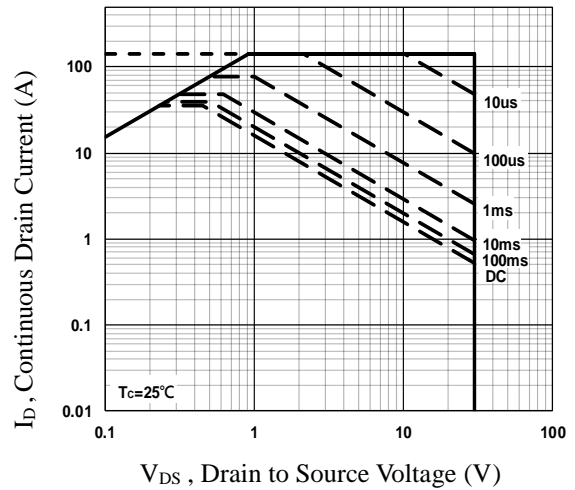

Fig.10 Q1 Maximum Safe Operation Area

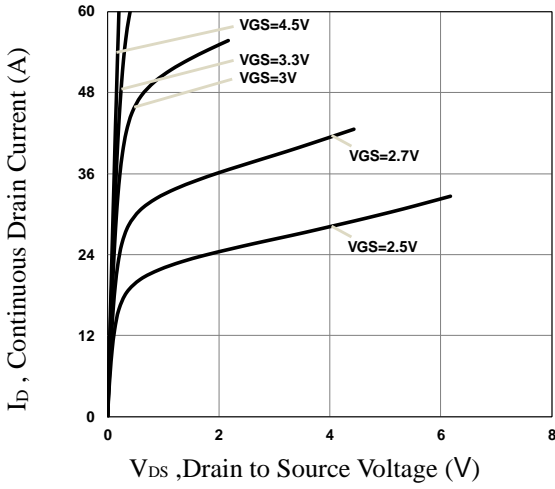

Fig.11 Q2 Typical Output Characteristics

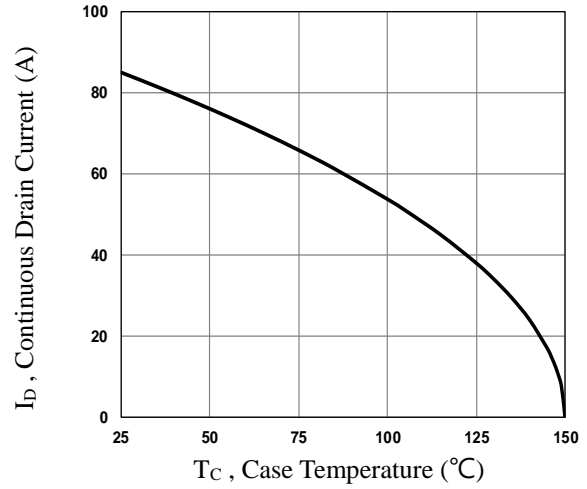

Fig.12 Q2 Continuous Drain Current vs. T_c

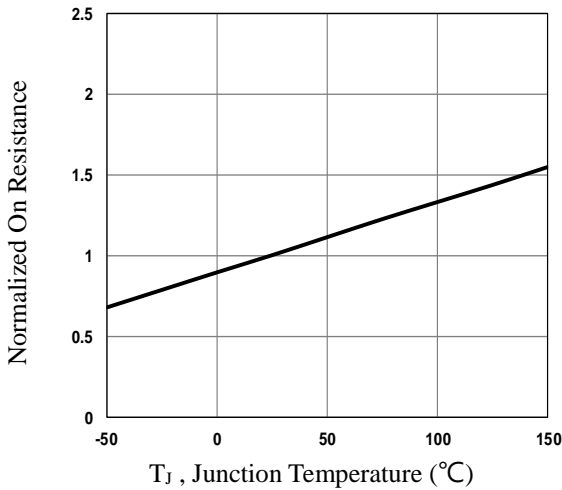

Fig.13 Q2 Normalized $R_{DS(ON)}$ vs. T_J

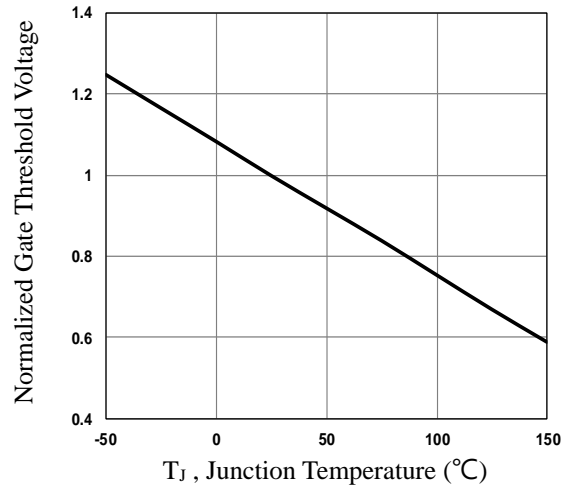

Fig.14 Q2 Normalized V_{th} vs. T_J

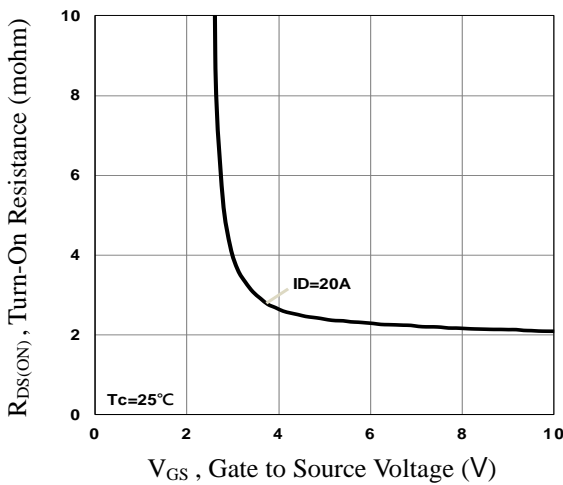

Fig.15 Q2 Turn-On Resistance vs. V_{GS}

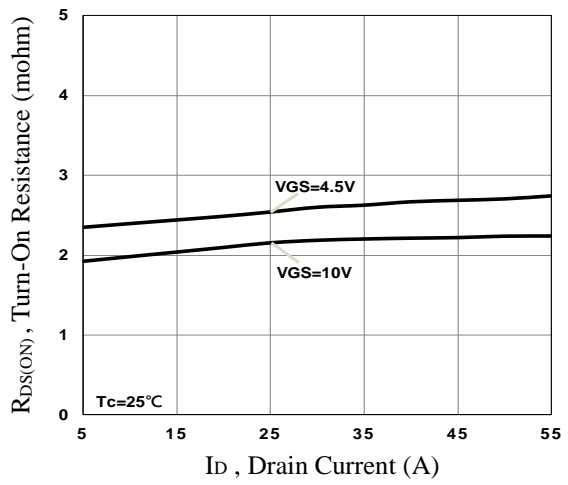

Fig.16 Q2 Turn-On Resistance vs. I_D

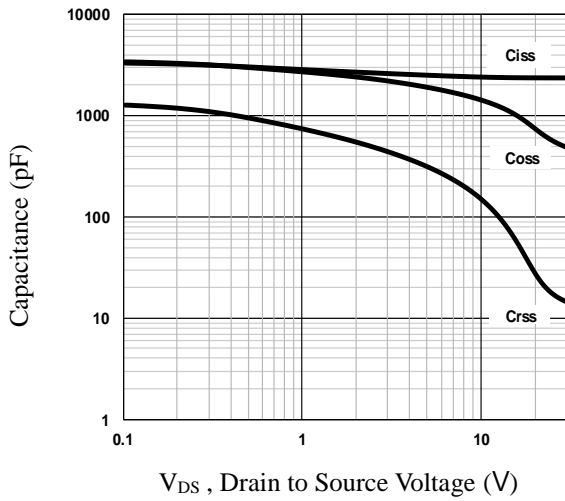

Fig.17 Q2 Capacitance Characteristics

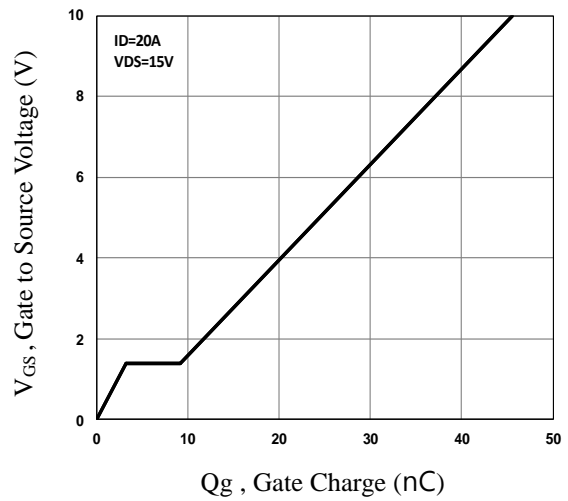

Fig.18 Q2 Gate Charge Characteristics

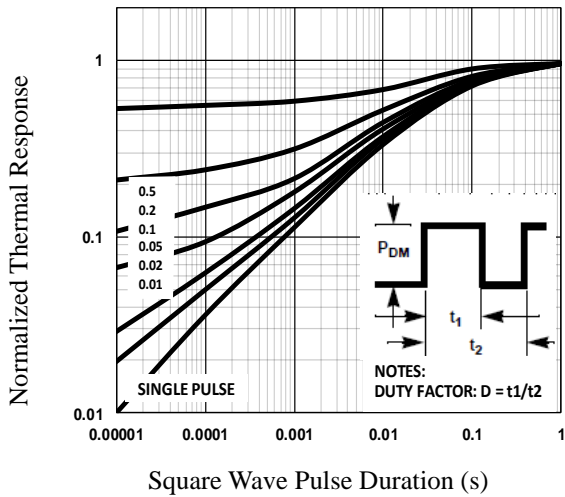

Fig.19 Q2 Normalized Transient Impedance

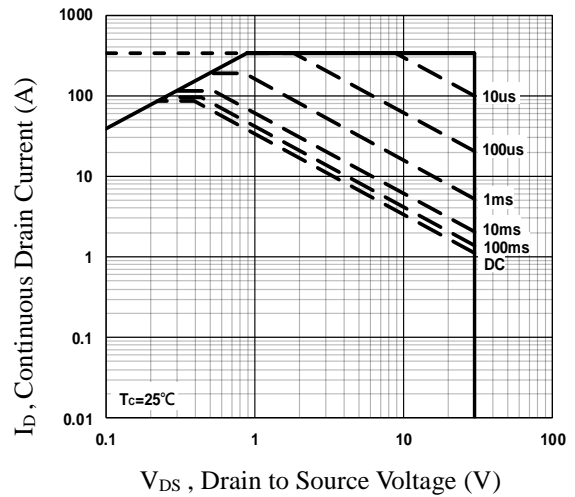

Fig.20 Q2 Maximum Safe Operation Area

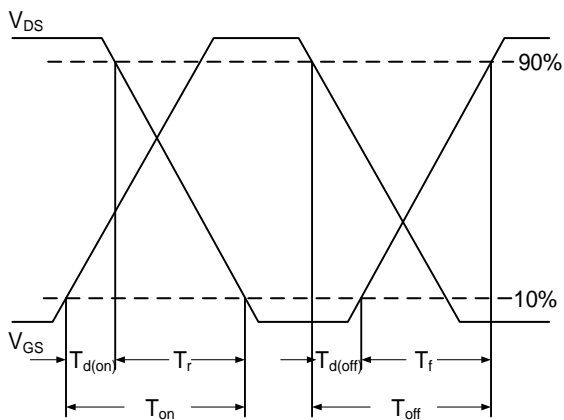

Fig.21 Switching Time Waveform

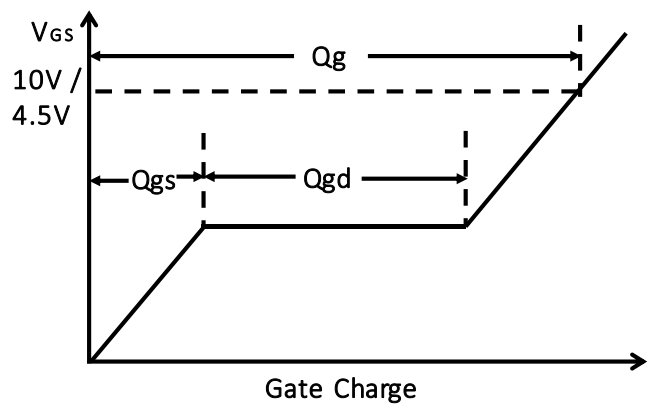
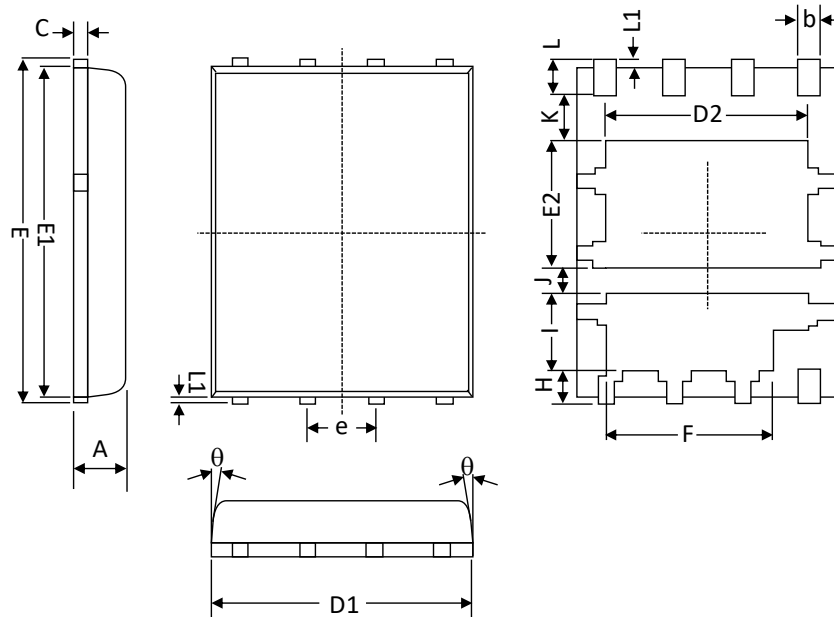

Fig.22 Gate Charge Waveform

PPAK5x6 Asymmetric Dual Package Information



Symbol	Dimensions In Millimeters		Dimensions In Inches	
	Min	Max	Min	Max
A	0.850	1.100	0.033	0.043
b	0.250	0.510	0.010	0.020
C	0.150	0.300	0.006	0.012
D1	4.800	5.300	0.189	0.209
D2	3.600	3.960	0.142	0.156
E	5.900	6.200	0.232	0.244
E1	5.400	5.850	0.213	0.230
E2	2.000	2.450	0.079	0.096
e	1.270 BSC		0.050 BSC	
F	2.550	3.250	0.100	0.128
H	0.430	0.810	0.017	0.032
I	1.100	1.420	0.043	0.056
J	0.300	0.600	0.012	0.024
K	0.500	-	0.020	-
L	0.350	0.800	0.014	0.031
L1	0.060	0.350	0.002	0.014
θ	0°	14°	0°	14°