

General Description

These P-Channel enhancement mode power field effect transistors are using trench DMOS technology. This advanced technology has been especially tailored to minimize on-state resistance, provide superior switching performance, and withstand high energy pulse in the avalanche and commutation mode. These devices are well suited for high efficiency fast switching applications.

BVDSS	RDSON	ID
-100V	41mΩ	-30A

Features

- -100V,-30A, RDS(ON) 41mΩ@VGS = -10V
- Improved dv/dt capability
- Fast switching
- 100% EAS Guaranteed
- Green Device Available

PPAK5X6 Pin Configuration

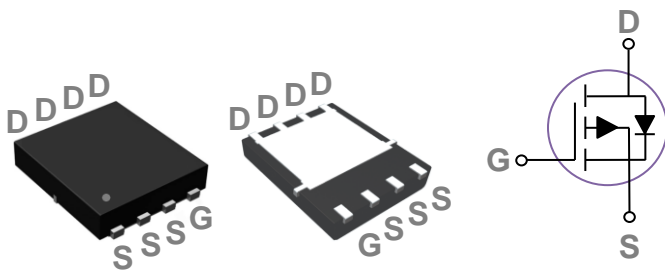

Applications

- Networking
- Load Switch
- LED applications

Absolute Maximum Ratings (Tc=25°C unless otherwise noted)

Symbol	Parameter	Rating	Units
V _{DS}	Drain-Source Voltage	-100	V
V _{GS}	Gate-Source Voltage	±20	V
I _D	Drain Current – Continuous (T _c =25°C)	-30	A
	Drain Current – Continuous (T _c =100°C)	-19	A
I _{DM}	Drain Current – Pulsed ¹	-120	A
EAS	Single Pulse Avalanche Energy ²	180	mJ
IAS	Single Pulse Avalanche Current ²	-60	A
P _D	Power Dissipation (T _c =25°C)	89	W
	Power Dissipation – Derate above 25°C	0.71	W/°C
T _{STG}	Storage Temperature Range	-55 to 150	°C
T _J	Operating Junction Temperature Range	-55 to 150	°C

Thermal Characteristics

Symbol	Parameter	Typ.	Max.	Unit
R _{θJA}	Thermal Resistance Junction to ambient	---	62	°C/W
R _{θJC}	Thermal Resistance Junction to Case	---	1.4	°C/W

Electrical Characteristics (T_J=25 °C, unless otherwise noted)
Off Characteristics

Symbol	Parameter	Conditions	Min.	Typ.	Max.	Unit
BV _{DSS}	Drain-Source Breakdown Voltage	V _{GS} =0V, I _D =-250μA	-100	---	---	V
I _{DSS}	Drain-Source Leakage Current	V _{DS} =-80V, V _{GS} =0V, T _J =25°C	---	---	-1	μA
		V _{DS} =-80V, V _{GS} =0V, T _J =85°C	---	---	-10	μA
I _{GSS}	Gate-Source Leakage Current	V _{GS} =±20V, V _{DS} =0V	---	---	±100	nA

On Characteristics

R _{DS(ON)}	Static Drain-Source On-Resistance	V _{GS} =-10V, I _D =-15A	---	34	41	mΩ
		V _{GS} =-4.5V, I _D =-10A	---	44	57	mΩ
V _{GS(th)}	Gate Threshold Voltage	V _{GS} =V _{DS} , I _D =-250μA	-1.2	-1.6	-2.5	V

Dynamic and switching Characteristics³

Q _g	Total Gate Charge	V _{DS} =-50V, V _{GS} =-10V, I _D =-15A	---	22	35	nC
			---	11	16.5	
			---	1	3	
Q _{gs}	Gate-Source Charge	V _{DS} =-50V, V _{GS} =-4.5V, I _D =-15A	---	4.4	7	ns
Q _{gd}	Gate-Drain Charge		---	5	8	
T _{d(on)}	Turn-On Delay Time		---	6	10	
T _r	Rise Time	V _{DD} =-50V, V _{GS} =-10V, R _G =6Ω I _D =-15A	---	15	25	pF
T _{d(off)}	Turn-Off Delay Time		---	1300	1950	
T _f	Fall Time		---	340	500	
C _{iss}	Input Capacitance	V _{DS} =-50V, V _{GS} =0V, F=1MHz	---	12	20	pF
C _{oss}	Output Capacitance		---	12	20	
C _{rss}	Reverse Transfer Capacitance		---	12	20	

Drain-Source Diode Characteristics and Maximum Ratings

Symbol	Parameter	Conditions	Min.	Typ.	Max.	Unit
I _S	Continuous Source Current	V _G =V _D =0V, Force Current	---	---	-30	A
I _{SM}	Pulsed Source Current		---	---	-60	A
V _{SD}	Diode Forward Voltage	V _{GS} =0V, I _S =-1A, T _J =25°C	---	---	-1	V
t _{rr}	Reverse Recovery Time	V _R =-100V, I _S =-10A	---	170	---	ns
Q _{rr}	Reverse Recovery Charge	di/dt=100A/μs, T _J =25°C	---	540	---	nC

Note :

1. Repetitive Rating : Pulsed width limited by maximum junction temperature.
2. V_{DD}=-50V, V_{GS}=-10V, L=0.1mH, I_{AS}=-60A., Starting T_J=25°C
3. Essentially independent of operating temperature.

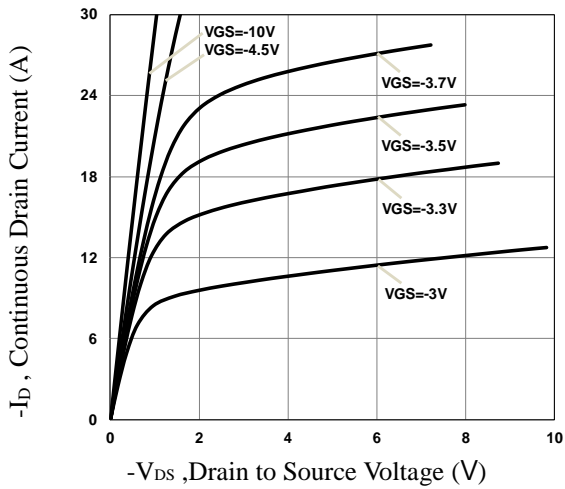

Fig.1 Typical Output Characteristics

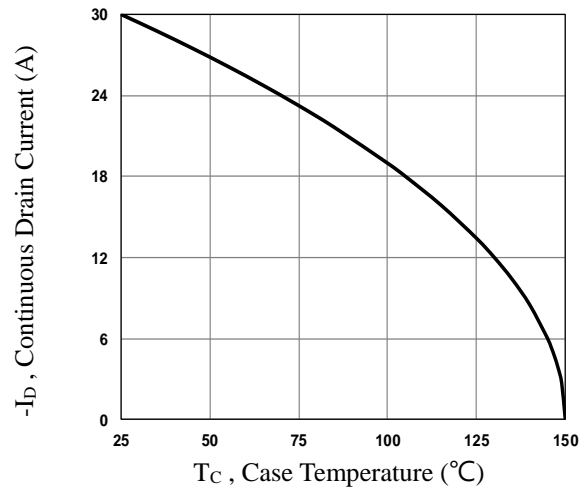

Fig.2 Continuous Drain Current vs. T_c

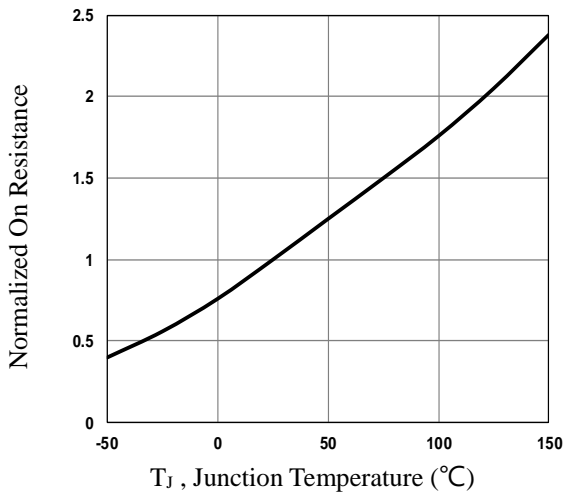

Fig.3 Normalized R_{DS(on)} vs. T_J



Fig.4 Normalized V_{th} vs. T_J

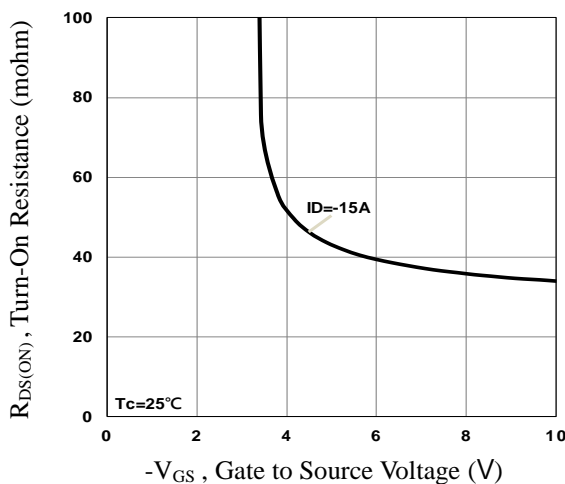

Fig.5 Turn-On Resistance vs. V_{GS}

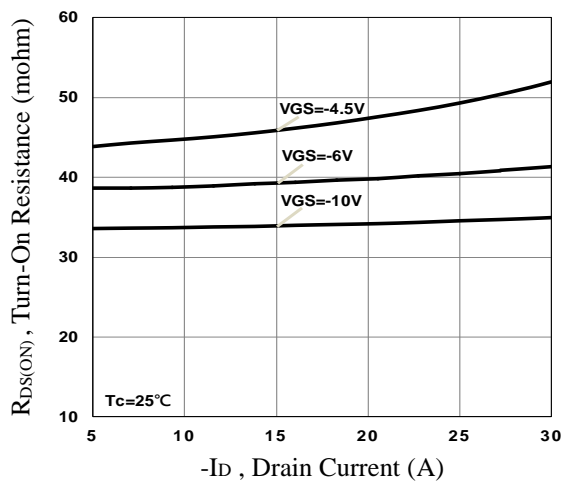

Fig.6 Turn-On Resistance vs. I_D

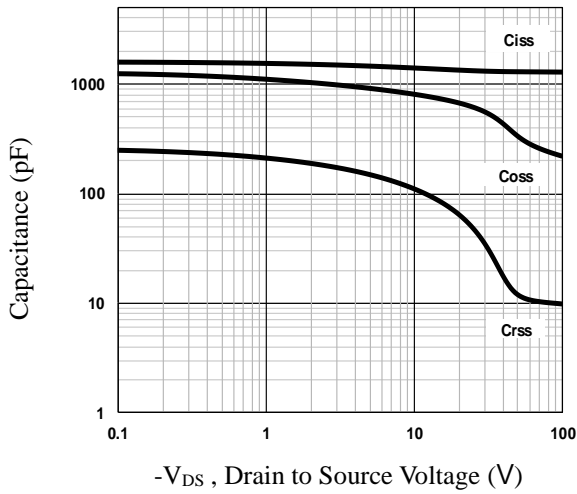

Fig.7 Capacitance Characteristics

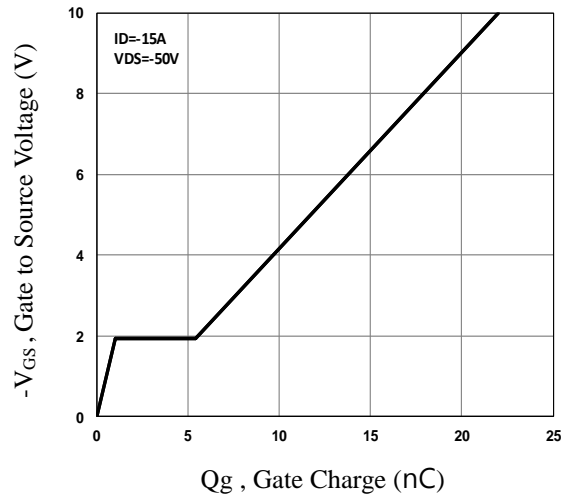

Fig.8 Gate Charge Characteristics

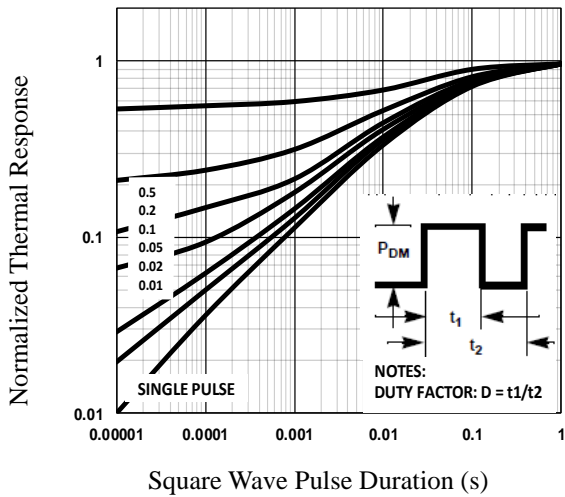

Fig.9 Normalized Transient Impedance

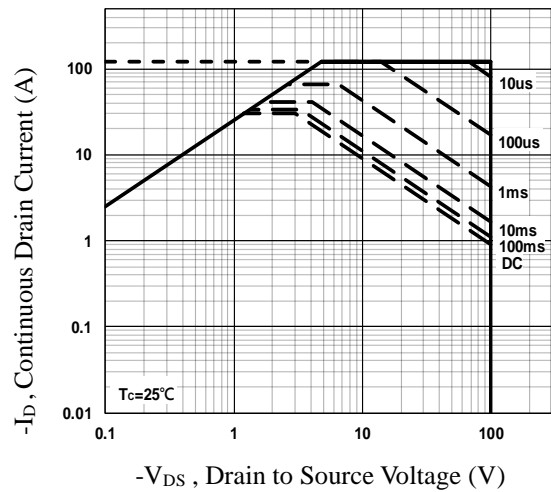

Fig.10 Maximum Safe Operation Area

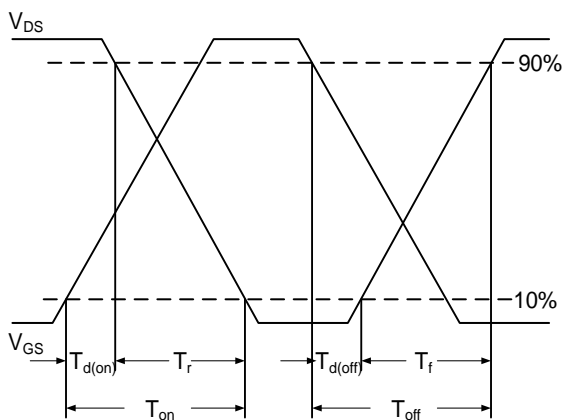

Fig.11 Switching Time Waveform

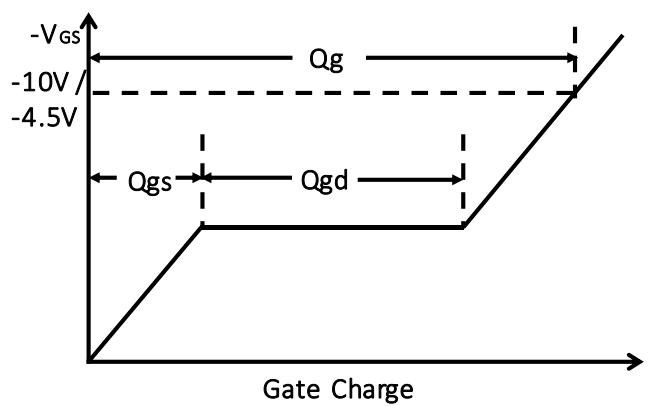
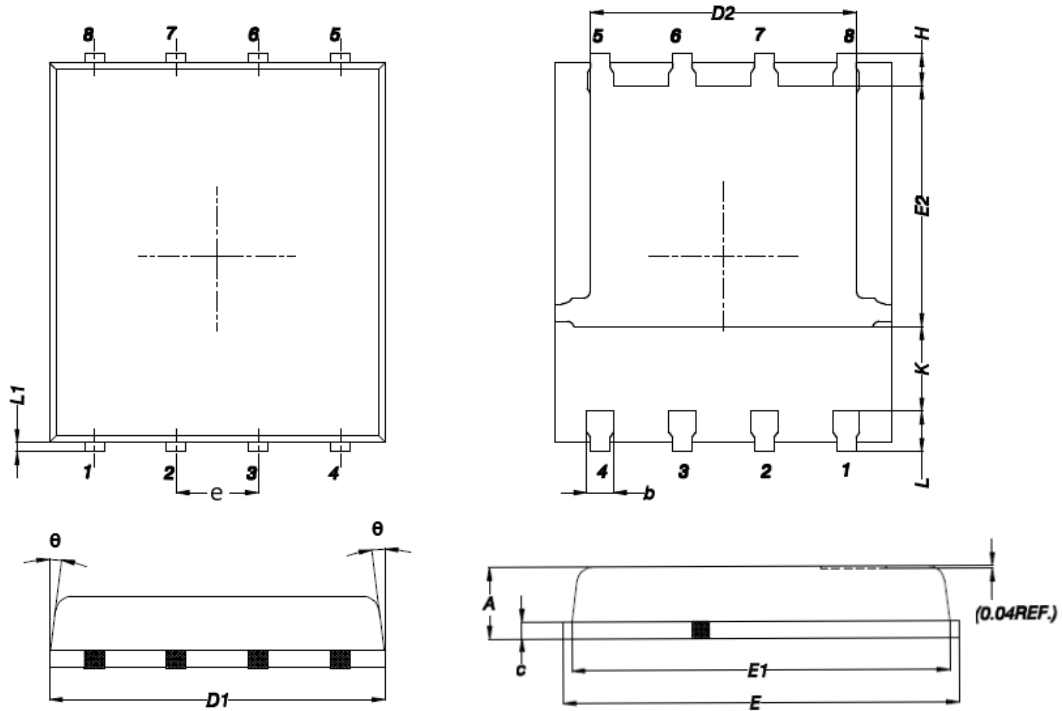

Fig.12 Gate Charge Waveform

PPAK5x6 PACKAGE INFORMATION



Symbol	Dimensions In Millimeters		Dimensions In Inches	
	MAX	MIN	MAX	MIN
A	1.200	0.850	0.047	0.031
b	0.510	0.300	0.020	0.012
C	0.300	0.200	0.012	0.008
D1	5.400	4.800	0.212	0.189
D2	4.310	3.610	0.170	0.142
E	6.300	5.850	0.248	0.230
E1	5.960	5.450	0.235	0.215
E2	3.920	3.300	0.154	0.130
e	1.27BSC		0.05BSC	
H	0.650	0.380	0.026	0.015
K	---	1.100	---	0.043
L	0.710	0.380	0.028	0.015
L1	0.250	0.050	0.009	0.002
θ	12°	0°	12°	0°

PPAK5X6 RECOMMENDED LAND PATTERN

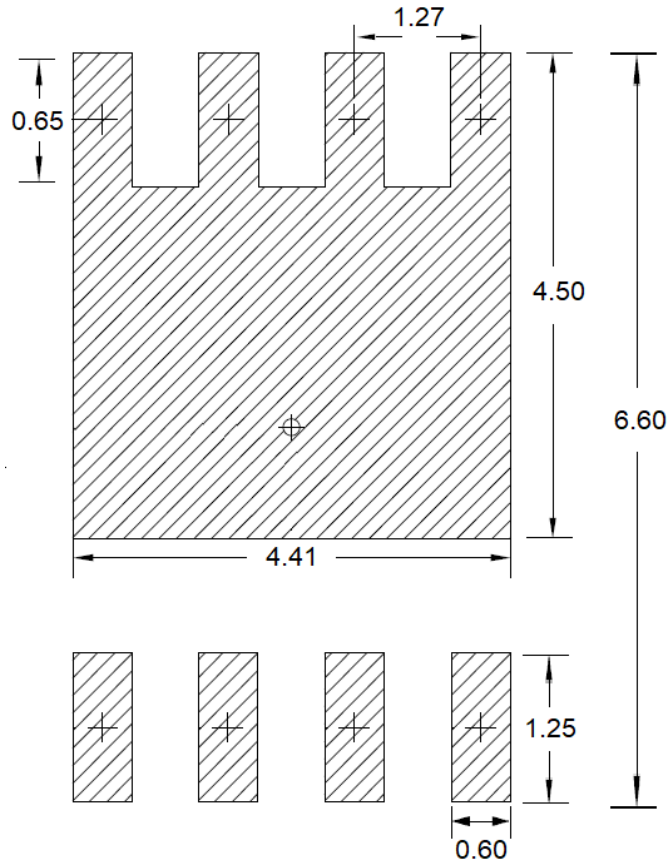

unit : mm